

# PRINCIPLES OF MANAGEMENT

(DBPM11)

(BBM)



**ACHARYA NAGARJUNA UNIVERSITY**

**CENTRE FOR DISTANCE EDUCATION**

**NAGARJUNA NAGAR,**

**GUNTUR**

**ANDHRA PRADESH**

## **Lesson-1**

# **INTRODUCTION, MEANING AND IMPORTANCE OF MANAGEMENT**

### **1.0 Objectives :**

The objectives of this lesson are:

- “ To know the concept and meaning of management.
- “ To understand about basic nature of management.
- “ To get knowledge of overall importance of management.
- “ To understand the difference between management and administration.
- “ To learn about the application of management principles.

### **Structure :**

- 1.1 Introduction**
- 1.2 Meaning and Definitions of Management**
- 1.3 Characteristic of Management**
- 1.4 Significance of Management**
- 1.5 Importance of Management**
- 1.6 Management Vs Administration**
- 1.7 Managerial skills**
- 1.8 Managerial Roles**
- 1.9 Universality of Management**
- 1.10 The Management challenges**
- 1.11 Summary**
- 1.12 Key words**
- 1.13 Self Assessment Questions**
- 1.14 Further Readings**

## 1.1 Introduction :

Management is universal in the modern industrial world and there is no substitute for good management. It makes human effects more productive and brings better technology, products and services to our society. It is a crucial economic resource and a life giving element in business. Without proper management, the resources of production ( men, machines and materials, money ) can not be converted into production. Thus management is a vital function concerned with all aspects of the working of an organization.

Management is a must to accomplish desired goals through group action. It is essential to convert the disorganized resources of men, machines, materials and methods into a useful and effective enterprise.

Thus management is the function of getting things done through people and directing the efforts of individuals towards a common objective.

## 1.2 Meaning and Definitions of Management :

Management is the art of maximizing efficiency, as a social process, a method of getting things done through others a plan of action and its direction by a co-operative group moving towards a common goal. Effective utilisation of available resources to achieve same objective is management.

Management is a comprehensive function of Planning, Organising, Forecasting Co-ordinating, Leading, Controlling, Motivating the efforts of others to achieve specific objectives. Management can precisely be called the rule – making and rule – enforcing body.

### Definitions :

According to **Harold Koontz** “ Management is the art of getting things done through and with formally organized groups “.

According to **Peter F. Drucker**. “ A Multipurpose organ that manages a business and manages managers and manages workers and works “.

According to **J.Lundy** “ Management is what management does. It is the task of planning executing and controlling “.

According to **Lawrence Appley** “ Management is the development of people and not the direction of things “.

According to **F.W. Tylor** "Management is the art of knowing what you want to do in the best and cheapest way".

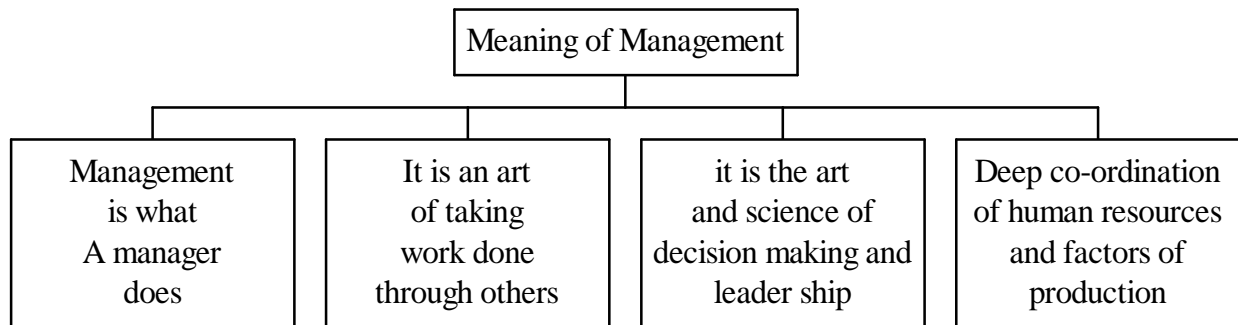

**Fig 1.1**

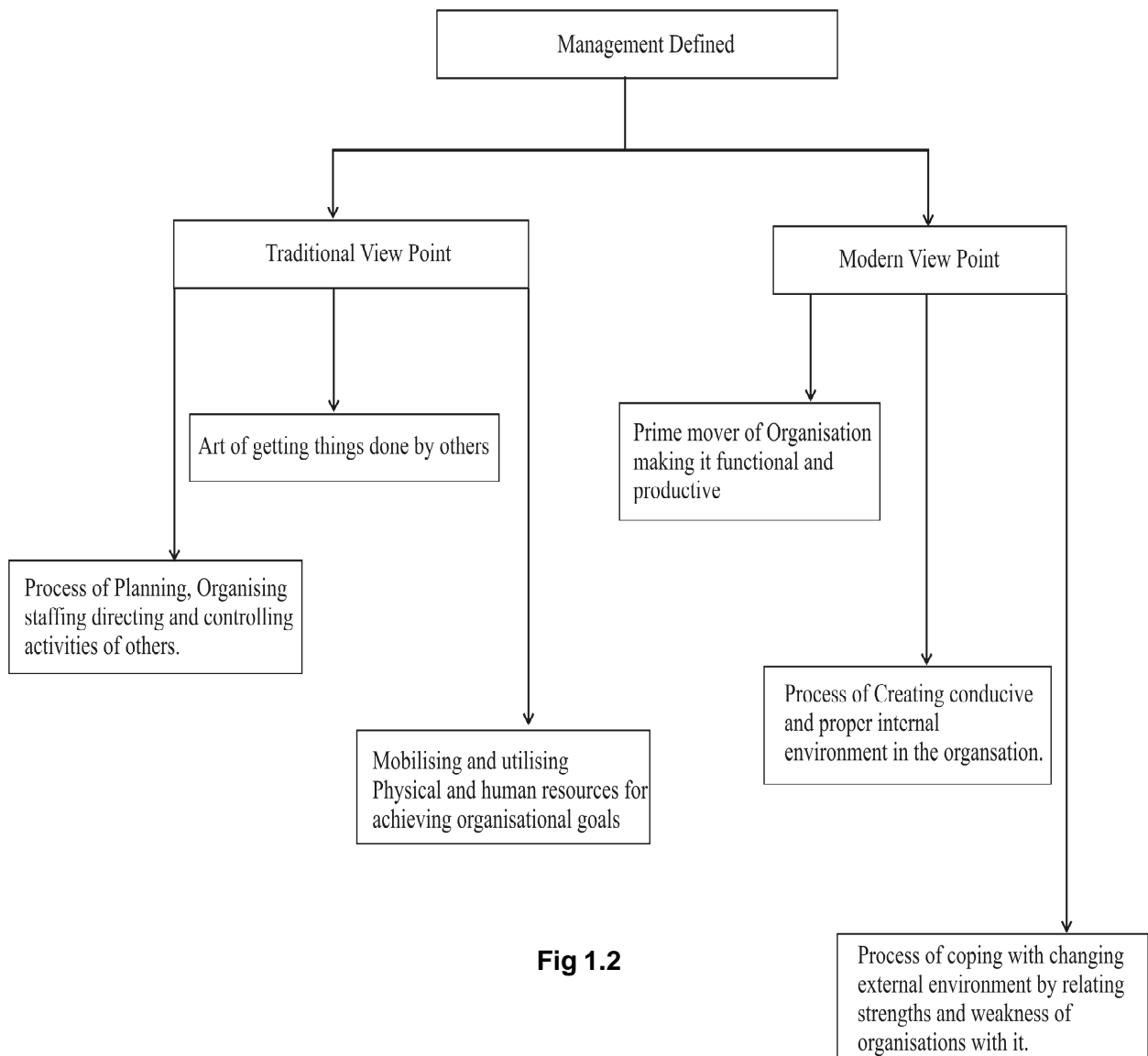

**Fig 1.2**

In nut shell it can be said that management as such is a science of managing men, machines, money materials and methods. It embraces all duties and functions that pertains to the initiation of an enterprise, its financing, the establishment of all major policies the provisions of all necessary equipment, the entailing of general form of orgauiisation, under which enterprise is to operate and the selection of the principal officers.

### **1.3 Characteristics of Management :**

#### **1.3.1 Management is a group activity :**

It is a group activity. Nobody can satisfy all his desires himself. Therefore he unites which his fellow- beings and works in an organized group to achieve what he cannot achieve individually. Massie has rightly called management as a " Co-operative group " .

#### **1.3.2 Management is Goal - oriented :**

According to **Theo Haiman** " Effective management is always management by objectives." Group efforts are directed towards the achievements of some predetermined goals. Mangement is concerned with establishment and accomplishment of these objectives.

#### **1.3.3 Management is a factor of Production :**

Management is not an end in itself. It is a means to achieve the group objectives. It is a factor of production that is required the co-ordinate with the other factors of production for the accomplishment of predetermined goals and objectives.

#### **1.3.4 It is a Universal Character :**

Management is essential in all types of concerns. It somewhere there is some human activity, management is must there. The basic principles of management are universal. These can be applied in all types of concerns i.e. business, social, religious, cultural, sports, educational a International technology.

#### **1.3.5 Management is needed at all levels of the enterprise :**

On the basis of the nature of work or target and the scope of authority, management is needed at all levels of the organisations e.g., top level, middle level and supervisor level.

#### **1.3.6 It is a distinct function :**

Management is a distinct function performed to fix and achieve stated objectives by the use of manpower and other factors of production. Different from the activities, techniques and procedures, the process of management consists of such functions as planning, organizing, staffing, directing, coordinating, motivating and controlling.

#### **1.3.7 It is a Social Process :**

Management is taken as a social process. It has a social responsibility to make reasonable use of scarce resources keeping in view the benefit of the community as a whole.

#### **1.3.8 System of Authority :**

Authority is the power to compel men to work in a specific manner. Management cannot work in the absence of authority. There is a chain of authority and responsibility among people working at different levels of the organization. There cannot be an efficient management without well defined lines of command and a superior subordinate relationship at the every levels of decision making.

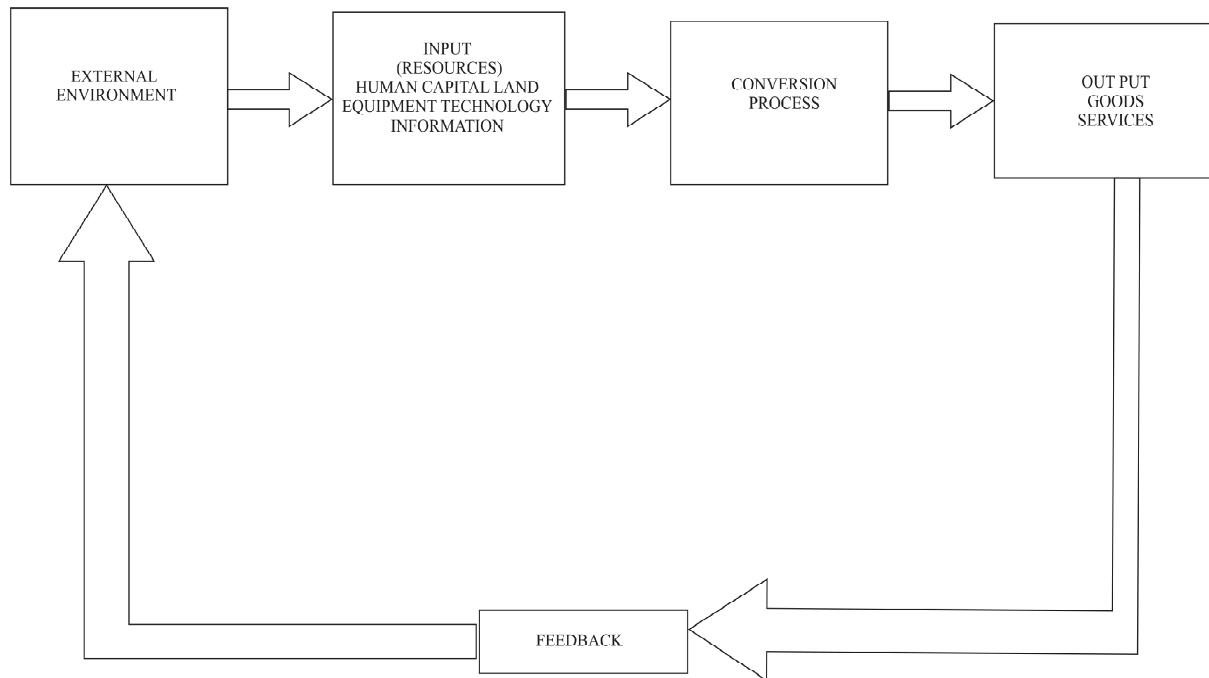

**Fig 1.3 : Management as a System**

#### **1.3.9. It is a dynamic function :**

Management has to be performed continuously, in a rapidly every changing business environment. It is constantly engaged in the moulding of the enterprise. It is also concerned about the change of environment itself so as to ensure the success of enterprise. Hence it is on-going function.

#### **1.3.10 Management is Intangible :**

It can be seen in the form of results and could not be actually seen. For ex: when we are not able to produce desired quantity, we say it is the result of poor management.

#### **1.3.11 It is Art as well as Science :**

Management is a science since its principles have universal application. Management is an art as the results of management depends upon the personal skill of managers. The art of the

manager is essential to make the best use of management science. Thus management is both science and art.

### 1.3.12 It is a Profession :

It has systematic and specialized body of knowledge consisting of principles, techniques, rules and laws. It can be taught as a specialized subject.

## 1.4 Significance of Management :

Management plays a unique role modern society. **Peter F.Drucker** has summarised the essence of management as “ under developed countries are under managed, it denotes the multi-dimensional significance of management. The significance of management can be broadly classified into the groups.

1. Advantages to the organization.
2. Advantages to the society.

### 14.1 Advantages to the Organisation :

#### (i) Determination of Objectives :

The success of various operations of an organisation mainly depends on the identification of its objectives. Objectives are identified and laid down by the management. They should be written and communicated to all others in the management.

#### (ii) Achieving of objectives :

It is the management which directs the group effort towards the achievement of various objectives. It brings the human and non- human resources together.

#### ( iii ) Meeting challenges :

All the policy decisions of an enterprise are taken by the management. It keeps in touch with the current environment and predicts what is going to happen in future. Through better planning and control, management steers a concern to meet the demands of the changing environment.

#### ( iv) Provides innovation :

Management infuses an enterprise with new ideals, imaginations and vision.

#### ( v) Smooth running of business :

Management helps in smooth running of business through better planning and control.

### 1.4.2 Advantages to the Society :

#### (i) Optimum utilisation of Resources :

It is the management which makes optimum utilisation of various resources such as land, labour, capital and enterprise. “No ideology, no ism, no political theory can win greater output with less efforts, only sound management”, says **Urwick** and **Brech**.

**( ii ) Social Benefits:**

Management raises the standard of living of the people by providing good quality products at the lowest prices. It also promotes peace and prosperity in the society through optimum use of scarce resources.

**( iii ) Role in national economic development :**

“Management is the crucial factor in economic and social development”, says **Peter F.Druker**. The development of a nation mainly depends on the quality of management of its resources. It is all the more true in a developing country like India, where productivity is low and the resources are limited.

**( iv ) Employment :**

The expansion and diversification activities of the managers in organisations create more employment to the society. This is very essential for our country.

## 1.5 Importance of Management :

Management is overall the most important factor because no business runs on itself, even no momentum. Every business needs repeated stimulus which can only be provided by management. Thus, management is dynamic, life giving element without which the “factors of production” will remain as were factors not become “Production”.

The following points bring out the importance of management.

1. Accomplishment of group goals.
2. Efficient operations of business.
3. Sound organization structure.

### 1.5.1 Accomplishment of group goals :

Success of a business enterprise depends on three important factors, viz

- ( a ) how economically and efficiently the organization has used its man power and physical resources.
- ( b ) how effectively it has adapted the enterprise to the prevailing business environment e.g. needs and expectations of the customers, policies of rivals and
- ( c ) how far the existing business policies have succeeded in realising the goals and objectives of the organisations.



This ensures efficiency in every sphere of activity and also enables quick modifications or alteration of a specific strategy or programme if any deficiency is noticed anywhere.

### 1.5.2 Efficient operation of business :

Efficiency of an organisation depends on ability, experience, skills, co-operation, zeal and enthusiasm of its employees. This, in turn, depends on proper motivation of these employees which can be accomplished only by an inspiring leadership provided by management. Management makes sure that the workers know their jobs, helps them in improving their skills and abilities in doing their jobs.

### 1.5.3 Sound organisation structure :

Management establishes a sound organisation that is in accordance with the desired objectives and goals and the work to be done to accomplish them. Management establishes a system of authority and responsibility relationships, who will command whom, who will be responsible for what, and who shall be accountable to whom.

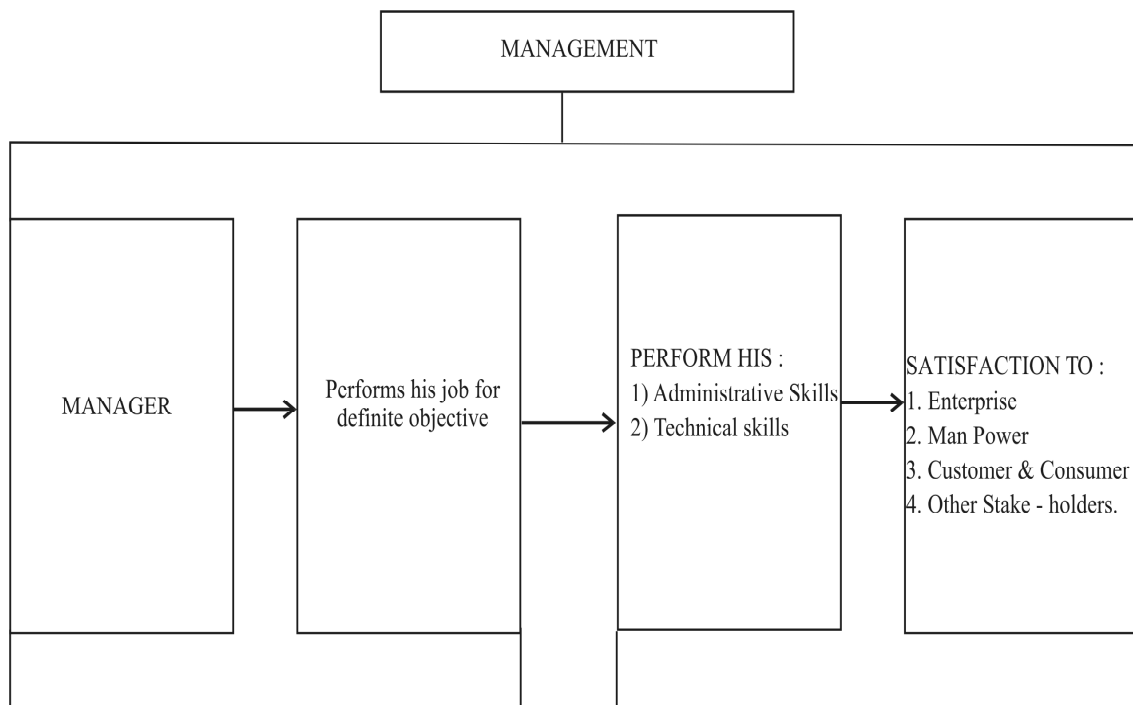

Fig 1.4

### 1.6 Management Vs Administration :

Administration is a thinking function and whereas management is a doing function.

**Sheldon** opines, "Administration is concerned with determination of the corporate policy, the coordination of finance, production and distribution the settlement of the compass of the organisation and the ultimate control of executive ".

Administration is generally regarded as a top level activity which is mainly concerned with laying down broad goals and objectives. Management on the other hand, is concerned with the accomplishment of those goals and policies.

On the other hand, management, is concerned with the execution of policy, within the limits set up by the administration and the employment of the organization for the particular object set before it. It is shown in the following figure.

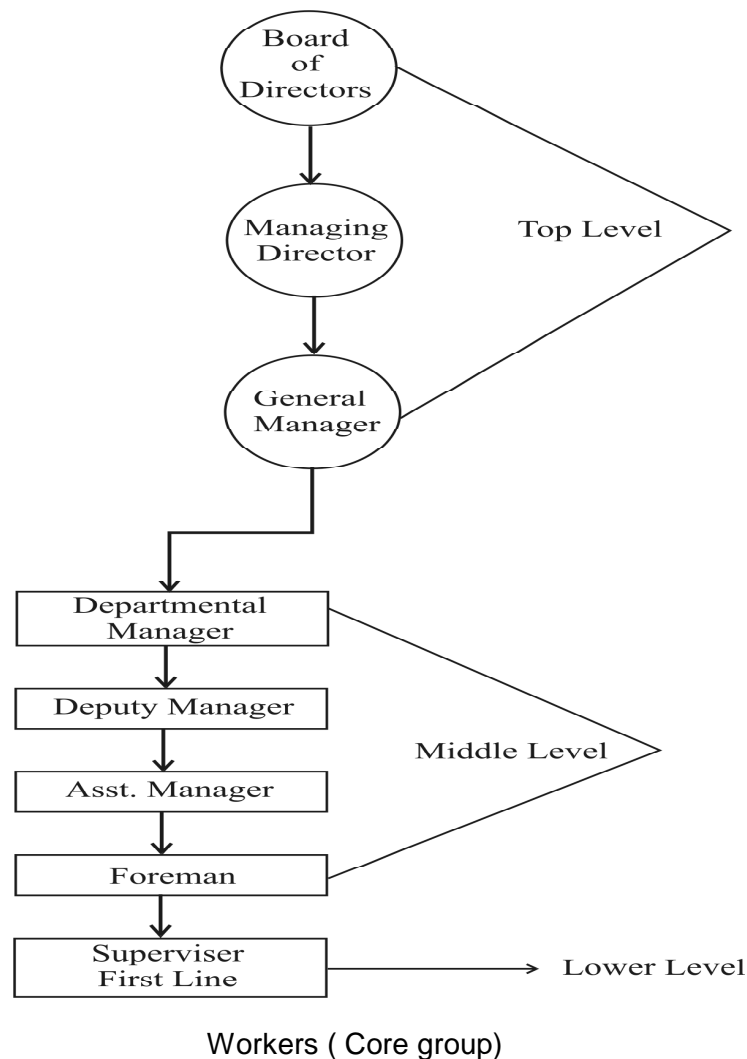

**Fig 1.5 Levels of Organisation**

Several authors have raised controversies between management and administrations. Now let us see the basic differences between Management and Administration.

### Distinction between Administration and Management

<b>Administration</b>	<b>Management</b>
1. It is concerned with the formation of objectives, plans and policies.	1. It means getting things done through and people.
2. It is a thinking function.	2. It is a doing function
3. It is a top- level management function.	3. It is a lower –level management functions.
4. It makes major policy decisions.	4. It makes decisions with the frame work of administration.
5. Decisions are influenced by external factors such as social, political, legal etc.	5. Decisions are influenced by internal factors such as values, beliefs, and opinions.
6. Administration is often associated with government policies.	6. Management is widely used in the business world

### 1.7 Managerial Skills :

A skill is an acquired and learned ability to translate knowledge into performance. It is the competency of a person that allows his performance to be superior. All managers need to possess various skills which are necessary to carry at their jobs successfully.

- (i) **Technical skills** : Technical skills are necessary to accomplish or understand the specific kind of working done in an organisation. The persons who are working with tools and techniques are needed such skill. Ex: Engineers, Scientists , Computer programmers etc. Technical skills are essential for first line managers who spend their time in training their subordinates and clear their doubts regarding were.
- (ii) **Human skills** : Human skill is the ability to work with other people in a cooperative manner. Human skill are essential to hence effective team work in the organisation. It involves patience, understanding trust and genuine involvement in interpersonal relationship.
- (iii) **Analytical skills** : These skills are essential to identify key factors and to understand the interrelate roles they play in a given situation. Analytical skills help a manager to establish cause and effect relationship. These skills also help a manager for problem identifying, solving and decisicu making.
- (iv) **Conceptual skills** : Such skills are essential to the managers to understand the overall working of the organisation and harmonise the working of the sub- systems for reaching the organisational objectives.
- (v) **Communication skills** : Communication skills are an important element of interpersonal skills. Communication is essential for proper implementation of orders. The best ideas

of manager may not be of any use if these are not properly communicated to subordinates.

**(vi) Decision-making skills :** Decision making is the process of reaching a point. It is choosing the best alternative of doing a thing from various choices available. Manager may make use of various techniques available for taking decisions.

## 1.8 Managerial Roles :

The more complex the organization, the more crucial his role. The success of and organisation will depend upon the caliber of a manager to achieve its objectives.

**Henry Mintzberg's** opines every manager, plays roles in three areas.

### 1.8.1 Inter personal Relationships :

- (a) As a Figure head.
- (b) Leadership role.
- (c) Liason officer.

### 1.8.2 Information processing :

- (a) Monitoring Information
- (b) Disseminating Information.
- (c) Organisations Spokesman.

### 1.8.3 Decision Making :

- (a) As an Entrepreneur
- (b) As a Conflict Handler
- (c) As a Resource Allocate
- (d) As a Negotiator

## 1.9 Universality of Management :

Universality of management means transmission of management knowledge from are organisation to a different organisation. From one country to another country and from are manager to incumbents through training and development. Management principles have universal application because management is a universal process. Universality of management principles also mean that managers are transferable from one country to another country. This concept has come into lime light ever since management was recognised as science, because science and scientific principles have universal application. But management is regarded as inexact science, its universal

application is questioned. Some authors have favoured it, where as other negated. We can observe their arguments as follows.

### 1.9.1 Arguments for universality :

- (i) **Management process is universal** : The management process is similar among managers. In the words of **Fayol**. There is a universal science of management applicable alike to commerce, industry, politics, religion war or philanthropy.
- (ii) **Management knowledge is universal** :
  - (a) **Management is culture - bound** : Culture consists of attitudes, beliefs, and values of a society. As management is people oriented there is always a possibility that application of management principles will be affected by culture. Ground rules under which a manager operates are different in different cultures then common strategies of management will not be possible.
  - (b) **Different objectives** : The objectives of an enterprise determine the type of management required. Different enterprises have different objectives. So these managerial needs are linked to these objectives.
  - (c) **Differences in Philosophies** : Philosophies of one organization vary from the other. Philosophies refer to those general concepts and integrated attitudes that are basic to an enterprise. Managers operate with a specific philosophy in a particular enterprise. This philosophy can be different even in the same type of enterprise.
- (iii) **Management skills and principles are transferable** : Management skills and principles are transferable from are person to another, from are organisation to another, from one country to another. When skills and principles can be transferred then it has universal applicability.

### 1.9.2 Arguments against universality :

Some exports feel that management principles and knowledge do not have universal application due to cross- culture differences. They are also of the view that same management skills can not be applied in all situations and fields and the skills are not transferable. **Peter Drucker**, states that “ The skill, the competence, the experience of management cannot, as such be transferred and applied to the organisation and running of other institutions . A career in management is, by itself, not a preparation for major political office or for leadership in the armed forces, the church or a university ”.

It can be concluded that basic principles and functions of management are universal in nature. These can be applied in every type of organisation and in every country. The application of these principles, however may vary from person to person. The art and practice of management always varies from situations to situations and it is culture bound.

### 1.10 The Management Challenges :

The management is facing challenges from within and outside the organisation. The complexities of managerial environment in the country would require a complete overhaul of management functions, roles and skills coping with the future challenges.

Challenges facing the management of tomorrow are :

- (a) Internationalization of Business.
- (b) Technological changes.
- (c) Transition from Industrial to knowledge based society.
- (d) Changes in work force.
- (e) Decision making process.
- (f) Ethical and Social Responsibility.

### 1.11 Summary :

In this chapter attempt is made to explain meaning and definitions of management. Management can be defined as an economic resource, as a group, as a subject of study and as a process. It also explained management Vs administration and concluded basically they are similar. It also needs an attempt to explain levels of management, and management principles are universally applicable subject to environmental modification.

### 1.12 Key words :

- Management : Art of getting things done through others
- Administration : Administration is concerned with the determination of overall objectives and policies of an enterprise.
- Managerial skill : A Skill is an acquired and learned ability to translate knowledge into performance.
- Technical skill : Skill required to accomplish or understand the specific kind of work done in an organisation.
- Conceptual skill : Skill required to understand the overall working of the organisation.
- Objectives : End to a specific course of action.
- Organisation : It is a group of people formed to achieve prescribed goal.
- Universality : It refers to application of knowledge and skills through out the world.

### 1.13 Self - Assessment Questions :

1. Define management. Describe its main characteristics.
2. What is management. Is there a difference between management and administration.

3. "Management is the art of getting things done through people " Explain.
4. What is the concept of universality of management ? Give arguments for and against this concept.
5. What are the skills required by managers in doing their jobs ?

### **1.14 Further Readings :**

1. Dalton Mc Farland, " *Management Principles and Practices* ", McMillan, New York.
2. James A.F. Stoner, R.Edward Freeman, " *Management* ", Prentice- Hall of India, New Delhi.
3. Oliver Sheldon, " *The Philosophy of Management* ", Sir Issac Pitman, London.
4. Harold Koontz, Cyril O 'Donnell and Weirich, *Management* ', McGraw Hill, New York.

**Dr. T. Rama Devi**

## Lesson–2

# MANAGEMENT AN INTER- DISCIPLINARY APPROACH ( MIX )

## 2.0 Objectives :

On completion of this lesson you should be able to understand:

- ∅ Management science and operation Research.
- ∅ Four distinguishing aspects of Management science.
- ∅ An inter - disciplinary team approach.

## Structure :

- 2.1 Introduction
- 2.2 Historical Development
- 2.3 Management Science – Four distinguishing aspects
- 2.4 Use of Scientific Method
- 2.5 The Systems Orientation
- 2.6 Management is an inter disciplinary approach
- 2.7 The use of Models.
- 2.8 Summary
- 2.9 Technical Terms
- 2.10 Self - Assessment Questions
- 2.11 Reference Books

## 2.1 Introduction :

The management science approach to the process of modern management is to provide managers of the organisation with a scientific basis for solving problems involving the interaction of components of the organisation in the best interests of the organisation as a whole.

The emphasis on this approach began with the scientific management movement which proposed a systematic application of scientific method to management problems. The basic objective to this approach is to transform all aspects of management phenomenon into the domain of standardised processes of decision making so that some of the available and tested decision making techniques can be utilised in solving some of the problems. In that respect the tools of management science are used to diagnose and analyse the problem and to find the best solution via the analysis of the possible consequences of different solutions.



## 2.2 Historical Development :

Management science is also referred to by other names such as quantitative analysis, decision sciences, systems analysis etc. Even though the application of scientific methods to management problems is comparatively more recent, some of the underlying principles were developed many centuries ago. For example, the probability theory was developed by Pascal and Calculus by Newton sometime in the 17<sup>th</sup> century. The dawn of the 20<sup>th</sup> century saw some early developments in the area of inventory control by Ford Harris and R.H. Wilson, some dynamic models developed by Markov and an analysis of queuing theory by A.K. Erlang. However, management science as a field of study began during world war II in Britain by a group of scientists under professor P.M.S. Blackelt. Commissioned by the army to analyse and solve some complex army operational decision problems. The group was known as army operational research group that was involved in finding solutions to highly complex and strategic situations such as convoy routing searching of submarines, optimum depth for detonating anti submarine charges, selecting optimum gun sites, planning defense tactics against suicides attacks etc. This was the birth of the operations research fields, which has since been successfully applied in solving problems in a variety of areas including resource allocation where the resources are scarce and exhaustible, inventory, control problems, maintenance and replacement, game theory, waiting line problems, routing etc.

Following the war, the applications of operations research techniques extended into industry specially large size industries such as oil refineries, steel and paper mills. The decades of 1950's and 1960's saw a dramatic development and refinement of these solutions to many complex industrial, business and military problems and these solutions were further aided by the development and extensive use of fast computers which handled large quantities of data and calculated various relationships of a large number of variables in a short period of time.

## 2.3 Management Science – Four Distinguishing Aspects :

According to **Paul Loomba**, management science is both a body of knowledge as well as an analytical approach to solving problems. As a body of knowledge, it consists of various management theories, models tools and techniques including theories dealing with individual, group and organizational behaviour, planning scheduling and control. This knowledge also develops an attitude with which the management scientists view and approach management problems and managerial situations. As an analytical approach to solving specific problems the management science models and techniques have been used extensively in various situations relating to administrative as well as operational problems.

Management science has four distinguishing aspects. These are :

1. Use of scientific method
2. A systems orientation.
3. An inter – disciplinary team approach
4. The use of models.

## **2.4 Use of Scientific Method :**

The Scientific Method is a logical, formalized and systematic observation of the phenomenon in order to establish a behavior of the system containing the problem, formulation of the hypothesis describing the interaction of the factors involved, verification of this hypothesis and implementation of the results. These steps are as follows:

### **Step one – observation :**

After the problem has been identified and isolated, all relevant information about the problem is gathered and objectively recorded and refined.

### **Step two – Formulation of hypothesis :**

A Hypothesis is what the manager believes will occur, based upon the information so gathered. Based upon this belief a course of action can be established.

### **Step three – Testing and verification of Hypothesis :**

In this stage, a course of action is adopted and the investigator verifies the correctness of the hypothesis by observing the results of the decision.

### **Step Four – Implementation, monitoring and control :**

When a course of action is accepted and is successful, the decision is implemented. This control process should be imbedded in the system so that continuous feedback is automatically measured and if there are any changes in any aspects or parameters of them, these can be quickly detected and rectified.

## **2.5 The systems orientation :**

The systems approach promotes the idea that the organization is an open system where the parts and all the sub-systems interact with each other as well as with the external environment.

## **2.6 Management is an inter – disciplinary and Multi – disciplinary approach :**

### **Inter disciplinary :**

The discipline of management science is primarily used to solve highly complex problems with a multitude of inter - related variables, with multi dimensional aspects, so that views of various specialists from diversified back grounds must be integrated, so that this diversity produces a synergistic effect. The inter – disciplinary approach becomes highly useful for many management problems which have physical, psychological, biological, sociological, technical and economic aspects. When specialists from various disciplines are called upon, some new and advanced approaches to old problems are often obtained.

The Army operational research group formed under Prof. Blackett in 1940 included Physicists, Mathematical Physicists, Astrophysicists, Mathematicians, Physiologists, Surveyors etc. Accordingly, this approach analysis the problem from various angles and aspects through the pooling of specialized talents and skills so that all ramifications of the problems can be considered.

### **Multi – Disciplinary approach :**

Management uses concepts, ideas, generalizations and principles of other disciplines to show better results. To enhance the quality of decisions, use of statistical devices and mathematical tools has become a style of the manager. Similarly, use of knowledge of economics, psychology sociology and anthropology for understanding human behaviour and analyzing the market forces has become a regular feature.

## **2.7 The use of Models :**

This is the most effective and most often used tool of management science for solving intense and complex problems. A model is simply a representation of a system or an object or a realistic situation in some form, formulated to explain the behaviour of the entity itself. It simplifies the real life situation which it reflects. For example, an organisation chart is a form of a model representing the structure of the organisation. A model is constructed in such a manner that it approximates those aspects of reality that are being investigated so that the system can be analysed and better decisions can be made.

## **2.8 Summary :**

Management science is both a body of knowledge as well as an analytical approach to solving problems. As a body of knowledge, it consists of various management theories, models, tools and techniques including theories dealing with individual, group and organisational behaviour, planning scheduling and control.

Management science has four distinguishing aspects. These are.,

1. Use of Scientific method.
2. A systems orientation
3. An inter – disciplinary team approach.
4. The use of models.

These aspects are solving specific problems within the organisation.

## **2.9 Technical Terms :**

1. Inter – disciplinary : Mutual relations
2. Orientation : Habitual
3. Model : Representation of an object made to scale

**2.10 Self Assessment Questions – (Essay type) :**

1. Define management science. Is it the same as scientific approach to management. Explain the difference, if any.
2. What are the four distinguishing characteristics of management science.
3. Explain the inter – disciplinary team approach and give the examples.

**2.11 Reference Books :**

1. B.S. Moshal , *Management Theory and Practice*, Galgotia Publishing Company, New Delhi, 1998
2. J.S. Chandan, *Management Theory and Practice*, Vikas Publishing House Pvt Ltd. New Delhi, 2004.

**Dr. D. Nageswara Rao**

## **Lesson – 3**

# **MANAGEMENT AN ART OR SCIENCE, PROFESSION**

### **3.0 Objectives :**

After completing this chapter, you should be able to know

- Whether management is an Art or science ?
  - ( a ) Management as an Art .
  - ( b ) Management as a Science.
- Management as a Science as well as an Art.
- Management as a Profession .

### **Structure :**

**3.1 Introduction**

**3.2 Management as an Art**

**3.3 Management as a Science.**

**3.4 Management as an Inexact or a Social Science.**

**3.5 Limitations**

**3.6 Management – A Science as well as an Art**

**3.7 Management as a Profession.**

**3.8 Conclusion.**

**3.9 Summary**

**3.10 Key words**

**3.11 Self Assessment Questions**

**3.12 Reference Books**

### **3.1 Introduction :**

The controversy with regard to the nature of management as to whether it is an art or science is very old and has created a lot of confusion. It is necessary to understand the real nature of management. The learning of art involves its continuous practice while learning of science involves assimilation of principles. The earlier captains of industry and managers used intuition, commonsense, hunches and experience in managing organizations. They were brilliant and hard working but still were not professionally trained managers. This was the main reason of controversy about the management.

### **3.2 Management as an Art :**

An art is often regarded as the systematic application of skill or knowledge in effecting accomplishment of results. It represents the methods or ways of doing specific things and indicates how an objective is to be achieved. The function of art is to effect change and accomplish results through deliberate efforts. Art is a personalised process and every artist has his own style. It is practice – based and perfection in it requires continuous practice over a long period of time.

#### **3.2.1 The main elements of Art are :**

- ( a ) Personal Skill.
- ( b ) Practical Knowledge.
- ( c ) Result – oriented approach.
- ( d ) Regular Practice.
- ( e ) Creativity.

#### **3.2.1 ( a ) Personal Skill :**

Like any other artist, a manager also uses his knowledge and skill in co – ordinating the activities of people in the organisation. Management is an art of dealing with people to accomplish desired results.

#### **3.2.1 ( b ) Practical Knowledge :**

Management is concerned with the application of knowledge and skill, unless managerial principles are used for making the things effective and better, these will not be covered in art.

#### **3.2.1 ( c ) Result – oriented approach :**

Management is result oriented because it is concerned with accomplishment of objectives. It aims at achieving maximum productivity at lowest costs.

#### **3.2.1 ( d ) Regular Practice :**

Like an artist, management always tries to attain higher and higher goals in order to reach the state of absolute perfection. This efficiency and effectiveness is attained through regular practice.

### 3.2.1 ( e ) Creativity :

Every art has an element of creativity and in this sense also management is one of the most creative art as it is concerned with getting work done through others by motivating them to work and co-ordinating their activities.

## 3.3 Management As a Science :

The word science literally means knowledge. It is a systematised body of knowledge acquired by mankind through observation and experimentation and which is capable of verification. The basic difference between Art and Science is that Art implies knowing, how the application, where as Science is concerned with knowing why? **In the words of Keynes** “ Science is a systematised body of knowledge which establishes relationship between cause and effect “.

### The essential features of Science :

1. It is a systematised body of knowledge that uses scientific methods for observation.
2. The Principles are evolved on the basis of continued observation.
3. The principles are exact and have universal applicability without any limitation.
4. The principles establish a cause and effect relationship between various factors.
5. The validity of scientific principles can be verified and they provide a reliable basis for predicting future events.

Let us now apply these features of science to management to determine whether it qualifies as science ?

### 3.3.1 Systematized Body of Knowledge :

Management is viewed as a science as it is an organised body of knowledge built up by management practioners, thinkers and philosophers over a period of time. “ Management science is body of systematised knowledge accumulated and accepted with reference to the understanding of general truths concerning management “.

The principles of management make use of scientific methods for observation. **Frederick W. Taylor**, the **Father of Scientific Management** applied scientific techniques to studies of planning, organising, staffing, motivating etc.

### 3.3.2 Continued Observation :

As applied to management, the principles of management have been developed after continued observation. The knowledge of management has been acquired through continuous and vigorous effects of many theorists and practitioners over a period of years.

### 3.3.3 Universal Application:

In the field of management, this knowledge has been accumulated and accepted with reference to general truths. There are certain fundamental principles of management which can

be universally approved. In the words of **Taylor** “ The fundamental principles of management are applicable to all human activities from our simplest individual acts to the working of our great corporations “.

### **3.3.4 Cause and effect Relation ship :**

Scientific principles establish cause and effect relationship between various factors. When applied to management the principles of management also establish cause and effect relationship.

**e.g. :** Poor planning and plant layout cause low productivity.

### **3.3.5 Validity and predictability :**

More knowledge or collection of facts is not science. It is only when the knowledge so gathered can be verified, it becomes science. The principles of management also be verified for their validity. The principles of management have been put to several tests and found to be valid. For Ex: a subordinate put under one boss will show better results, than a subordinate who has to follow two or more bosses. Further, the principles of management by finding cause and effect relationship can serve reliable basis for predicting further events.

## **3.4 Management As An InExact or a A Social Science :**

From the above discussion, it is clear that management is a science. But it must be noted that unlike physics, chemistry and Biology, It is not exact or accurate science. The principles of management cannot be considered as fundamental truths. At times, they may not bring desired results and may not have universal application. The main reason for the inexact of the science of management is that it deals with human beings whose behaviour cannot be predicted. Thus we can say that management is a “ Soft Science” or “ behavioural science “ and it belongs to a group of social Sciences like Sociology, Political Science.

## **3.5 Management as a pure Science suffers from the following limitations :**

1. It does not consist of fundamental truths only.
2. The Principles of management do not always have a universal application.
3. Behaviour of human beings cannot be predicted.
4. Management lacks certainty about results.

## **3.6 Management – A Science as well as an Art :**

From the above we can say that management has elements of both art and science. It may not be proper to term it as pure science or pure art. In fact, it is a science as well as an art because science and art are both complementary to each other. As **Cossa** has said “ Science requires art, art requires science, each being complementary to each other “. It may be concluded that there is no hard and fast line between art and science of management . The Science has to solve problems and establish principles which might be applied with a benefit to the art.



**In the words of Dean Stanely F. Teele**, “ Management is a mixture of art and science. The present ratio is about 90% art and 10% science. Though a very great deal of developments are presently increasing that proportion which can properly be called science. I am willing to venture a guess that by the end of another generation the ratio will be 80% Art and perhaps 20%. Science ” .

### 3.7 Management – As a profession :

A profession is an “ occupation backed by organized knowledge and training and to which entry is regulated by a representative body “.

Thus, all professions are occupations in the sense that they provide means of livelihood.

However, all occupations are not professions because some of them lack certain features of a profession.

#### Features of Profession :

- (i) Organised body of knowledge, principles and techniques.
- (ii) Formal training and education.
- (iii) Restriction on entrance.
- (iv) Existence of a representative body.
- (v) Prevalence of a code of conduct.
- (vi) Spirit of service to the society.

#### Application of the features to the management :

##### (i) Organised body of knowledge :

Management has its own body of systemalised knowledge which contains the principles and techniques. These principles established cause and effect relationships and are capable of universal application. **A.P.M. Fleming** has rightly remarked that management has “ . a technique quite a part from the technology of the particular works concerned.

##### ( ii) Formal training and Education :

Management is not merely theory. Here the person is prepared to take practical decision in business. To impart management education and training, there are a large number of formal institutes in various countries, including India. Several tools of management such as business, Psychology, Business law, Statistics, Data- processing, operations research and cost accounting etc. have been developed. The business houses today prefer to employ those managerial personal who have obtained a professional degree in management from some recognised institutes.

**(iii) Restriction on Entrance :**

Entrance into a profession is restricted by standards established by it. But management does not restrict the entry of people into managerial jobs with only a special academic degree.

**(iv) Existence of an organisation :**

1

Various management organisations have come into existence in India to guide the managers in

- (i) To regulate the behaviours of members.
- (ii) To create a code of conduct for guiding the activities of the Profession.
- (iii) To promote and build up the image of management as a Profession.

In India, All India Management Association and Indian Association for Management Development were established to train the managers.

Function of Association is to manage and co- ordinate the research work in the various areas of management. It is, however, true that norms of managerial behaviour have not yet been established and we do not have uniform methods of entry.

**( v ) Prevalence of a Code of Conduct :**

Every profession formulates its own ethical codes for the conduct of its members. But there is no uniform code of conduct for the practicing managers. In spite of it, managers are socially responsible. They have to protect the interest of the owners, workers, suppliers, consumers and the government

**(vi) Spirit of Service to the Society :**

Though professionals charge fee for the service rendered, they give priority to service over the desire for monetary reward.

For Ex: a doctor earns his livelihood from his profession of medicine but service to society is upper most in his mind. As managers enjoy the respect of society, they should also fulfill their social obligation.

**3.8 Conclusion :**

Management does not fulfill all the requirements of a profession. But it is moving in the direction of a profession on account of the

- a. Support of a well defined body of knowledge.
- b. Growing emphasis on formal training of managers.
- c. Growing emphasis on the ethical conduct of management personal and their social responsibility.

**Management Process :**

Management was defined as a Process . Process means a series of operations or actions necessary to achieve certain results. It is a human and social process directed at individuals to get things done by them. It consists of many actions or activities or functions which are to be carried out in a logical sequence. Management is a continuous process because it has no definable end and steps or elements involved in it are to be performed in a continuous cycle. The elements or activities which are performed in this process are known as functions of management.

**Brech** states “ Management is a social process entailing responsibility for the effective and economical planning and regulation of the operation of an enterprise “.

Management functions varies from are another to another.

**According to Henry Fayol :**

Functions of management are classified into five categories.

- (i) Forecasting and Planning.
- (ii) Organising
- (iii) Commanding
- (iv) Co-ordinating and
- (v) Controlling

**According to Lyndall Urwick**

He classified the management functions into six categories.

- (i) Forecasting
- (ii) Planning
- (iii) Organising
- (iv) Command
- (v) Co-ordination and
- (vi) Control

**According to L . Gullick :**

He explained the functions of management by a keyword “ POSDCORB ”. Each letter of the key word denotes are functions i.e.

- P** for Planning
- O** for Organising
- S** for Staffing
- D** for Directing
- Co** for Co-ordinating
- R** for Reporting
- B** for Budgeting

## Evaluation of Organic Management Functions

1.	Early concept borrowed	Plan	Organise	Command	Discipline
2.	Management process developed by Fayol	Plan	Organise	Command	Co- Ordinate, Control
3.	Further Modification	Plan organise Direct control			
4.	Modified by Behavioural Influence	Plan	Organise	Motivate	Control
5.	Recent modifications	Plan	Organise	Integrate	Measure
6.	Suggested further modification	Plan	Organise Achieve Appraise		

On the basis of the classification of managerial functions made by various famous advocates and authors, we can conclude that the following comprehensive classification of managerial functions.

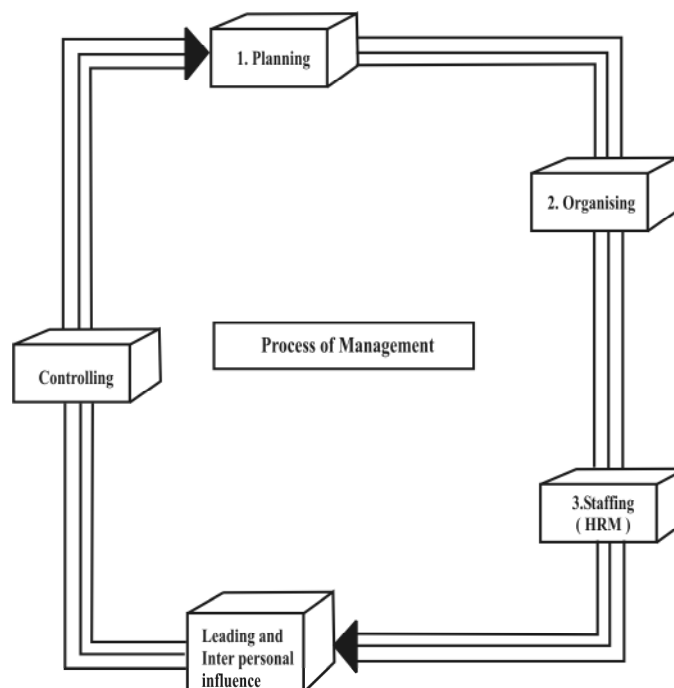

### Managerial Functions

**Planning :**

Planning is the basic managerial function. Planning helps in determining the course of action to be followed for achieving various organisational objectives. It is a decision taken in advance, what to do, when to do, how to do, and who will do a particular task. Planning is a process which involves “ thinking before doing “. Planning is concerned with the mental state of the manager. Hence planning is regarded as a thinking function than a doing functions. Other functions of management such as Planning, Organising, Directing and Controlling are also undertaken after planning. It is a continuous process that takes place at all levels of management.

It involves the selection of organizational objectives and developing policies, procedures, programs, budgets and strategies. Thus a detailed planning is done in the beginning but the actual performance is reviewed and suitable changes are made in plans when actual execution is done.

**Organising :**

Organising is to arrange, guide, co-ordinate direct and control the activities of other factors of production viz, men, material, money and machines. So as to accomplish the objectives of the enterprise.

**Steps in organising :**

- (i) To identify the work to be performed
- (ii) To Classify the work
- (iii) To assign these groups of work to individuals
- (iv) To delegate authority and ascertain the responsibility.
- (v) To co-ordinate these authority responsibility relationships of various activities.

A Sound organisation contributes greatly to the continuity and success of an organisation. How ever, an organisation is not an end in itself. Therefore organisation structure should be flexible. Thus organisation provides the necessary frame work with in which people associate for the attainment of business objectives.

**Staffing :**

According to **O'Donnel**, Staffing is “ filling, and keeping filled position in the organisation structure through defining work force requirements, appraising, selecting, compensating and training “.

The function involves manning the positions created by organisation process. It is concerned with human resources of an organisation.

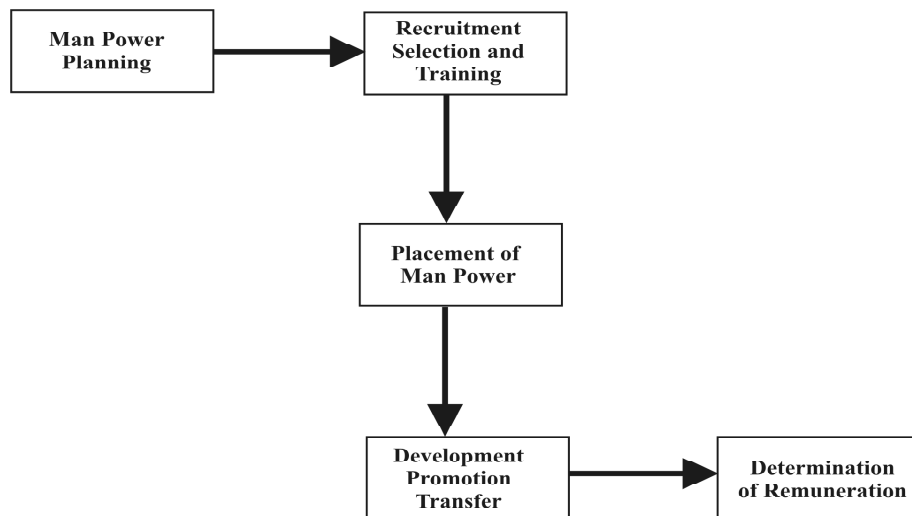

### Staffing consists of the following :

- (i) man power planning i.e. assessing manpower requirements in terms of quantity and quality
- (ii) recruitment, selection and training
- (iii) placement of man power.
- (iv) development, promotion transfer and appraisal
- (v) determination of employee remuneration.

Every manager in an organisation has to perform the staffing function in one form or the other, in order to get things done through others. But it is decidedly a difficult managerial function as it concerns human beings whose behaviour and actions cannot be predicted, and that is why it has become a distinct and specialised branch of management.

### Directing :

“ Direction is moving to action and supplying stimulative power to the group “-says **R.Terry**. After planning, organizing, and staffing the manager has to guide and supervise in which a manager influences the actions of subordinates. It is the final action of the manager in getting others to act after all preparations have been completed. Directing is a continuous function and is performed at all levels of management.

The main activities involved in directing are as follows :

- (a) Leading
- (b) Communication
- (c) Motivation
- (d) Supervision

**(a) Leadership :**

A manager has to issue orders and instructions to his subordinates. He has to guide his subordinates in their work in order to improve their performance and achieve enterprise objectives. It is the process by which an executive imaginatively directs and influences the work of others in choosing and attaining specified goals by mediating between the individual and organisation. In such a manner that both will get satisfaction at maximum. It is the ability to build up confidence and zeal among working groups and to create an urge in them, to be led.

In order to be a successful leader, a manager must possess the qualities of foresight , drive, initiative, self –confidence and personal integrity. Different situations demand different type of leadership, such as autocratic leadership, democratic leadership and free rein leadership.

**(b) Communication :**

Communication means sharing of ideas in common. The essence of communication is getting the receiver and the sender tuned together for a particular message. It refers to the exchange of ideas, feelings, emotions and knowledge and informations between two or more persons. Nothing happens in the management till communication takes place.

Communication is a two – way process as it involves both information and understanding. It may be written, oral, gestural communication flows downward from a superior to subordinates and upward from a superior to subordinates and upward from subordinates to a superior. It also flows between two or more persons operating at the same level of authority

Communication is essential at all levels of management for decision making and planning. It increases managerial capacity and facilitates control. It has been rightly said that good managers are good communicators and poor managers are poor communicators.

**(c) Motivation :**

Motivation is the psychological process of creating urge among the subordinates do certain things or behave in the desired manner. A manager has to provide some personal incentive to the subordinates to motivate, persuade and inspire them for contributing their best towards the achievement of enterprise objectives . A sound motivational system must be productive, competitive comprehensive and flexible and it must consider the psychological, social, safety, ego and economic needs of the workers.

**(d) Supervision :**

Supervision is an important directing functions of management. After issuing instructions, the manager or the supervisor to the job is required to see subordinates at work to ensure maximum utilisation of resources, to get the required and directed was done and to correct the subordinate whenever they go wrong. Though supervision is performed at all levels of management, the major responsibility for it lies with the first line of management.

**Co-ordination :**

Co-ordination is essential to channelise the activities of various individuals in the organisation for the achievement of common goals. The management has to see that the work of different segments is going according to predetermined targets and corrective measures have to be taken if there is any deviation. Co –ordination creates a team spirit and helps in achieving goals through

collective efforts. It is the orderly arrangement of group effort to provide unity of action in the pursuit of common objectives.

### Controlling :

Controlling is the process of ensuring that the organization is moving in the desired direction and that progress is being made towards the achievement of goals.

Steps in controlling :

- (a) establishing standards for measuring work performance.
- (b) measurement of actual performance and comparing it with the standards.
- (c) finding variances between the two and the reasons therefore, and.
- (d) taking corrective action for correcting deviations so as to ensure attainment of objectives.

The management process mentioned above is Universal to all the managers irrespective of levels and organisations with little deviations. It is never ended process, because after controlling is completed, it gives the basis for planning and again planning starts. That is why management process is represented like a circle as follows.

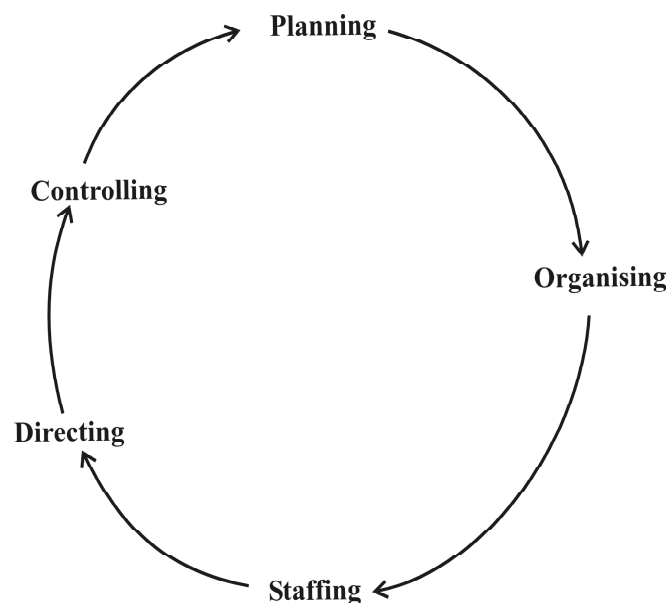

### 3.9 SUMMARY :

In this chapter an attempt is made to explain management as science or art, and stated that it has the characteristics of both the areas. Attempt is also made to explain management as a profession. The lesson bring out the concepts and formulation of the managerial functions, such as planning, organising , Staffing, Directing and Controlling. They form as a continuous process of managerial performance in the organisation.



**3.10 KEY WORDS :**

1. **Management** : Management means what the manager does.
2. **Art** : Systematic Application of skill or knowledge.
3. **Science** : It is a systematized body of knowledge
4. **Management Process** : The Sequence of events to be performed to fulfill the task of management .
5. **Planning** : It is a process which managers set objectives, assess the future, and develop courses of action to accomplish objectives.

**3.11 SELF ASSESSMENT QUESTIONS :**

1. Is Management a Social Science ?
2. Is Management an Art or Science ?
3. Is Management a Profession ? Give reasons for your answer.
4. Discuss Management as a Process.
5. What are the various Functions of Management ?

**3.12 REFERENCE BOOKS :**

1. Koontz, Harold and Cyril O'Donnell "*Management : A System and contingency Analysis of Managerial Functions*", Mc Graw Hill, Tokyo – 1976
2. Drucker , Peter F, "*Management Tasks, Responsibilities and Practices* "Allied Publishers Private Ltd., New Delhi.
3. Dr. C.B. Gupta "*Management Theory and Practice* " Sultan Chand & Sons, Educational Publishers, New Delhi.

**Dr. T. Rama Devi**

## **Lesson - 4**

# **EVOLUTION OF MANAGEMENT THOUGHT**

### **4.0 Objectives :**

The objectives of this lesson are to :

- know the development of managerial knowledge from time to time.
- know about various approaches to study management.

### **Structure :**

#### **4.1 Introduction**

#### **4.2 Approaches to Management**

##### **4.2.1 F.W. Taylor**

##### **4.2.2 Henry Fayol**

##### **4.2.3 Bernard**

##### **4.2.4 Peter F Drucker**

#### **4.3 Summary**

#### **4.4 Key Words**

#### **4.5 Self - Assessment Questions**

#### **4.6 Reference Books**

### **4.1 INTRODUCTION :**

Management thought is as ancient as human civilization, because the need for management has arisen ever since people started forming into groups. However, the study of how managers achieve results is predominantly a twentieth century phenomenon. The rich history of the management made it resourceful, varied and multi-dimensional. Management is transient from time depending on the prevalent philosophies. Industrial Revolution brought out the necessity of developing a theory of management. Hence, a large variety of concepts emanated in the field of management from classical to neo-classical to modern. The chronological contributions of management thinkers is known as Evolution of Management thought which have formulated management theory. For the purpose of study it is divided into three stages, each covering different period and ideology of the contributors.

- a. Bureaucratic model – Max Webber – 1900
- b. Scientific Management – F.W. Taylor- 1910
- c. Process Management – Henry Fayol – 1910

**The Neo- Classical Theory :**

It consists of two streams of thought

- a. Human Relation Movement – Elton Mayo and Roethlisberger – 1930
- b. Behavioural Sciences Movement – Maslow, Mc Gregor – 1940

**The Modern Management Theories**

It comprises three streams of thought

- a. Quantitative Approach – Taylor – 1950
- b. Systems Approach – Boulding, Johnson – 1950
- c. Contingency Approach – Lorsch, Lawrence

**4.2 APPROACHES TO MANAGEMENT THOUGHT :**

The initial efforts towards management principles could be traced from the organisational practices of Roman Catholic church, military organisations and the cameralists who proposed certain principles like scalar chain, specialisation, line of command, selection of subordinates and their training and unity of doctrine etc., later on certain valuable contributions pertaining to mostly the field of human resources and relations come from James Walt, Robert Owen, Charles Babbage and Henry Poor. However, the real development of management thought has started with the Scientific Management by F.W.Taylor.

**4.2.1 Scientific Management by F.W. Taylor :**

**Frederick Winslow Taylor** has made the major attempt to systematize the management theory through the publication of “ The Principles of Scientific Management “ in 1911. Eventually, he is known as the Father of Scientific Management. He wrote Scientific Management with his long experience as an engineer at various levels of functioning from an apprentice to the Chief Engineer of a steel company. His philosophy is also known as Taylorism.

According to F.W.Taylor, it is not proper to find just a way for doing something, a manager has to find the one right way. His major concern was to increase efficiency in production, it includes not only to lower costs and raise profits, but also to increase pay for workers through their higher productivity. Further he emphasized that managers should be responsible for analysis and planning of work in advance, whereas workers should be responsible for the performance of the work as per plans.

**Principles of Scientific Management :**

Taylor has endeavored to introduce scientific approach in business and management and wanted to make it as exact as possible. The basic principles are stated as follows.

- a. Replacing rules of thumb with science.
- b. Harmony in group action than discord.

- c. Cooperation than individualism.
- d. Working for maximum output than restricted output.
- e. Developing workers to the fullest extent.

### **Elements of Scientific Management :**

F.W. Taylor opined ' Management is the art of knowing exactly what you want men to do and seeing that they do it in the best and cheapest way. He advocated the following elements of Scientific Management.

### **Work Study :**

Work Study is related to analyzing work to be performed by eliminating unnecessary operations and finding out the quicker way of doing it. Work study eliminates wasteful and unnecessary operations, and increases production through scientific principles such as.

1. Time study : To determine the time required performing the job in the best possible way.
2. Method Study : To keep the cost of production at the minimum level.
3. Motion Study : Objects of motion study are.
  - i. Studying the movements of operations and machines.
  - ii. Identifying and eliminating unnecessary and wasteful motions.
4. Fatigue study : The object of this study is to examine how long a person can perform the standard task without causing any adverse effect on his health and efficiency.

### **4.4.3 STANDARDISATION OF TOOLS AND EQUIPMENT :**

According to this principle proper tools and equipment are essential for increasing the speed of work.

### **4.4.4 SCIENTIFIC SELECTION, PLACEMENT AND TRAINING :**

Taylor wanted a radical change in the methods and procedures of selecting workers. Workers should be selected by considering their education, experience and attitude towards work. The placement of workers should be such that only the most suitable persons are assigned the work. Placement should be on the basis of merit rating. Workers should be given training to make them suitable for the jobs.

### **Introduction of Functional Foremanship :**

Taylor advocated the concept of functional foremanship. He felt that workers and factory executives should be freed from the burden of ' Planning and Designing '. He suggested eight functional Specialists, the first four attached with planning work and the next four for the shop work.

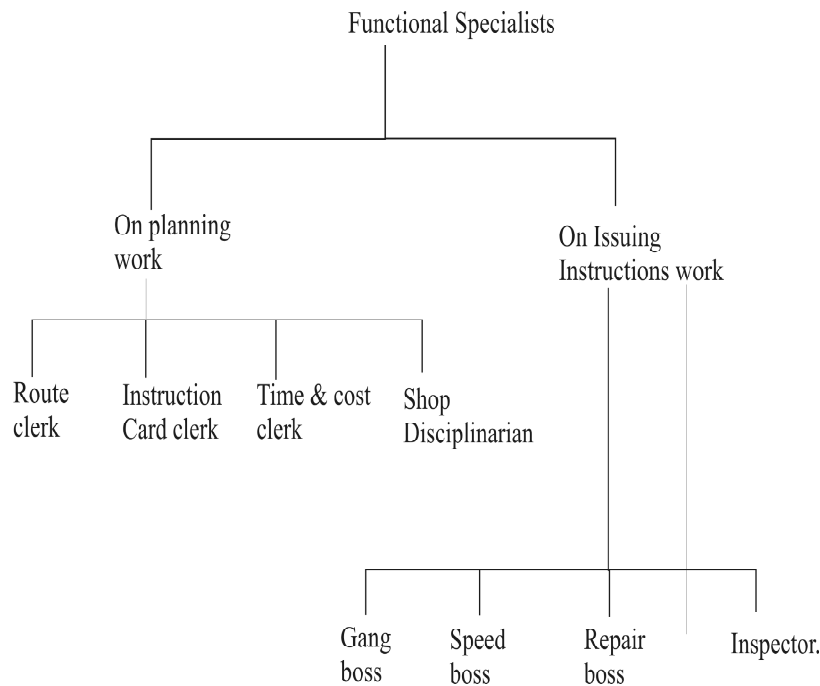

- a. Route clerk lay down the sequence of operations.
- b. Instruction card clerk prepares an expert method of doing a work.
- c. Time and cost clerk is to keep records of time spent by different workers on different jobs.
- d. Shop disciplinarian deals with cases of breach of discipline and absenteeism.
- e. Gang boss is to assemble and set up various equipment and tools.
- f. Speed boss ensures that machinery are run at optimum desired speed.
- g. Repair boss ensures regular cleaning, servicing and repair of machines.
- h. Inspector is to ensure that the workers perform their work as per requirements or not.

By dividing the work in this way Taylor wanted to streamline the working of production department.

### **Introducing Costing System :**

As a tool of Scientific Management cost accounting serves the following purposes.

1. Cost reduction and cost control.
2. Estimation of costs and preparation of budgets.

3. Increase efficiency and reduce wastage.
4. Channelise production on right lines.

**Mental Revolution :**

Taylor's basic idea was to bring change in the mental attitude of workers and management towards each other through scientific approach. Workers were feeling that management was exploiting them, getting heavy work and paying meager amounts, whereas management had the misgiving that workers always grumbled about the load of work, follow go-slow policy etc. Mutual understanding and co-operation between management and workers was an essential aspect advocated by Taylor. It can be achieved through mental revolution.

**Advantages of Scientific Management :**

1. Wastage can be reduced
2. Workers abilities are utilized through training
3. Activities are specialized.
4. Establishes performance standards
5. Use of monetary and other incentives for increasing the productivity of worker's

**Criticism on Scientific Management :**

Scientific Management has been criticized due to the following factors :

1. Taylor's expectation of efficiency was not possible in an average worker. The standards set for workers under time and motion studies were too high.
2. His emphasis on efficiency at all costs turned workers into mere machines.
3. The incentives to workers were not commensurate with the increase in productivity.
4. This approach ignores the average worker, because of tough competition.
5. Specialisation makes the work repetitive and monotonous.
6. Taylor concentrated more on problems of factory management and did not touch upon the general management like planning, coordinating and controlling etc.,

In spite of criticism Taylor's theory and principles have considerable influence on modern management thought.

**4.2.2 OPERATIONAL MANAGEMENT THEORY- HENRY FAYOL ( 1841-1925) :**

Henry Fayol started his career as a junior engineer in a coal mine company in France and became its General Manager in 1880. He wrote a book titled on "General and Industrial Management" in 1916 which was published in English in 1949.

The contributions of Taylor and others are aimed mostly at workshop level and did not concentrate on the development of overall organisation structure. At about the same time, the real

contributions to the promotion of management at the organization level are given by Fayol that is why he is known as Father of Modern Operational Management.

Henry Fayol observed that management was an activity common to all human undertakings whether in the home, business, Government. He divided all activities of a business enterprise into six categories.

- a. Technical activities – production.
- b. Commercial activities – buying, selling.
- c. Financial activities – search for and optimum use of capital.
- d. Security activities – protection of property and persons.
- e. Accounting activities – including statistics.
- f. Managerial activities.

### **Functions of Management :**

Fayol used the term 'administration' instead of 'management' . He divided the key functions of administration into five sub groups such as –

**Planning** - to forecast and provide means for the future.

**Organising** – provides everything useful to its functioning.

**Co-ordinating** – binding together, unifying and harmonizing all activities.

**Commanding** – leads the personnel in a better way.

**Controlling** – ensuring every thing goes as per plans.

### **General Principles of Management**

Fayol has provided fourteen principles to manage the organisation successfully and to build up an effective organisational structure. They are enumerated as follows –

1. **The Division of work** – The work is divided into parts, and one person does only one things rather than doing every thing himself. It is to be adopted to take advantages of specialization. It gives maximum productivity and efficiency.
2. **Parity between Authority and Responsibility** – Authority and responsibility go side by side and should be commensurate to each other.
3. **Discipline** – Discipline is in essence. It refers to respect for agreements which are directed at achievements, obedience, energy and respect.
4. **Unity of Command** – One person should receive order from one superior only. There should not be multiple bosses to one subordinate because it will lead to division of responsibility and escapism.
5. **Unity of Direction** – Fayol observed without unity of direction, unity of action, Co-ordination of strength and focusing of effort cannot be achieved. According to this

principle, each group of activities with the same objective must have one head and one plan.

6. **Subordination of Individual interest to general interest** – Management should make efforts to reconcile individual interests with common interests must be sacrificed to common interest, if there is a conflict between these two.
7. **Fair remuneration** – Fayol wanted the remuneration to be paid to employees to be fair and equitable to provide the maximum possible satisfaction to employees and employer.
8. **Centralisation** - It refers to concentration of authority in the hands of few i.e., top management. There must be good balance between centralization and decentralization of authority.
9. **Scalar Chain** – Fayol was of the opinion that a hierarchie channel called scalar chain is necessary to ensure unity of command and effective communication. Scalar chain is a chain of superiors and subordinates from the highest ranks to the lowest ranks. Command and Communication must go through this chain.
10. **Order** – It means the right man in the right job and right material in the right place.
11. **Equity** - Fayol was of the opinion that to encourage workers to fulfil their duties with devotion and loyalty, management should deal with workers with equity- based on kindness and justice.
12. **Stability of tenure** – It means the long term existence of people in the organisation. Fayol felt that instability of personnel is both the cause and effect of bad management so these should be a stability in tenure.
13. **Initiative** – Initiative is regarded as thinking out and execution of a plan. Employees should be given the chance and opportunity in taking initiative in deciding and implementing the plans.
14. **Esprit do corps** – It refers to harmony and mutual understanding among the members of the organization.

According to Fayol, manager should require the following qualities –

- I. Physical health
- II. Vigour
- III. Mental ability
- IV. Moral energy
- V. Firmness
- VI. Willingness to accept responsibility.
- VII. Educational qualifications.
- VIII. Technical qualifications.
- IX. Experience.



He recognized the need for principles of management, techniques, managerial ability for efficient management. Management theory has universal validity even though management practices may vary according to socio - economic environment and culture. So Fayol's principles of management have universal applicability.

### 4.2.3 BARNARD AND SOCIAL SYSTEMS THEORY :

The contributions of Chester Barnard to the management are over whelming. His book “ The Functions of the Executive “ is regarded as the most influential book on the management during the pre- modern management era. His analysis of management is truly a social systems approach. In determining the tasks of executives, he has analysed the nature of cooperative social systems, as he found non- logical factors also influencing human behaviour in the organisation. The major contributions of Barnard can be presented as follows :

1. **Concept of Organisation** : Barnard suggests that classical concept of organization does not fully explain the features of an organization. He has defined formal organization, as a system consciously coordinated activities or courses of two or more persons. He opined organization, exists in the following conditions -
  - i. There are persons able to communicate with each other.
  - ii. They are willing to contribute to the action.
  - ii. They attempt to accomplish a common purpose.
2. **Formal and informal Organisations** - Bernard suggested that executives should encourage the development of informal organisation, to serve as a means of communication, to bring cohesion in the organisation, and to protect the individuals from dominance and on slaughter of the organization. Both the formal and the informal organisations, depend on each other and there is continuous interaction between the two. Therefore in managing an organization, managers should take into account both types of organisation.
3. **Elements of Organisation** – According to Barnard, there are four elements of a formal organisation they are –
  1. a system of functionalisation so that people can specialize.
  2. a system of effective and efficient incentives to induce people to contribute to group action.
  3. a system of power which will lead group members to accept the decisions of the executives and.
  4. a system of logical decision making.
4. **Authority** – Barnard does not agree with the classical view that authority transcends from the top to bottom. He has given a new concept of authority known as “ acceptance theory of authority “ or “ bottom –up authority “. In his opinion, a person does not obey an order because it has been given by a superior but he will accept a communication as being authoritative.

**5. Functions of the executive** – Barnard has identified three types of functions which an executive performs in a formal organisation.

**These are –**

- i. maintenance or organizational communication through formal interactions.
- ii. the securing of essential services from individuals to achieve organizational purpose.
- iii. the formulation and definition of organizational purpose.

**6. Motivation** - Apart from financial incentives Barnard has suggested a number of non - financial techniques for motivating people these are –.

- i. Opportunity of power and distinction.
- ii. Pride of workmanship.
- iii. Pleasant organization.
- iv. Mutual supporting and personal attitudes.
- v. Feeling of belongingness.

**7. Executive Effectiveness** - High order of responsible leadership makes the executive effective. Executive leadership demands high caliber, technological competence, and technical and social skills.

**8. Organisational Equilibrium** - Organisational equilibrium refers to the matching of individual efforts and organisational efforts to satisfy individuals. This equilibrium is not static but dynamic. The equilibrium of the organization, depends on the individuals working in it, other organizations and the changes in the society. Thus Barnard's contribution shows how he was concerned for the development of the organization through social systems.

#### 4.2.4 CONTRIBUTION OF PETER F. DRUCKER :

Among the contemporary management thinkers, Peter F. Drucker was a legend in the field of management. He has made many outstanding contributions to the development of management principles. Following are some of his views on management.

**1. Nature of Management** : According to Drucker the basic objective of management is to lead towards innovation. He advocates that management is creative and innovative in nature rather than bureaucratic. Because managers practice their activities in an ever changing environment, they always deal with the human beings whose behaviour is complex and unpredictable. He was warned that too much professionalisation of management is dangerous. He has also emphasized that managers should not only have skills and techniques but should have the right perspective putting the things into practice.

- 2. Management By Objectives :** ( MBO) Management By Objectives is regarded as one of the most important contributions of Drucker to the discipline of management. He introduced this concept in 1954. It is regarded to be his remarkable contribution to the management thought. It consists of environmental scanning, identification of key result areas, setting objectives for departments as well as to subordinates, motivation and performance appraisal. He opines that MBO is a management Philosophy rather than a management technique.
- 3. Management Functions :** According to Drucker, management is the organ of its institution. He sees management through its tasks. Drucker has attached great importance to the objective setting function and has specified eight areas where clear objective setting is remained. These are market standing, innovation, productivity, physical and financial resources, profitability, managerial performance and development, worker performance and attitude and public responsibility.
- 4. Organisation Structure :** Drucker always advocates for the parallel growth of second line managers because whenever the existing managers vacate their offices, organizations should not suffer from the non- availability of experienced managers, if there is gap, it is detrimental to the performance of the organization.
- 5. Organisation Changes :** Further Drucker has forecasted that organizations face many changes because of rapid social and technological changes. Hence dynamic organization structures are essential than static and bureaucratic structures.
- 6. Federalism :** Federalism means centralization of control and decision making in decentralized structure. Drucker has felt the need for close links between the decisions adopted by the top management on the one hand and by autonomous unit on the other hand.
- 7. Activity Analysis, Decision Analysis and Relation Analysis :** In the words of Drucker, organization is a means to the end of business performance and business results. The first question that every manager must ask himself is what is our business and what it should be? Then the organization should be designed to attain the objectives of the business.

The contributions of Drucker, especially his futurism, objective - orientedness and perception of changes stood as hall - marks in the management evolution.

### 4.3 SUMMARY :

Thus Taylor's principles laid emphasis on improving production through control of work situations with the help of scientific techniques such as work study, time study, motion study, fatigue study and functional foreman ship etc., Fayol's principles related to the overall administration of the enterprise. Fayol generalized his experience into developing a theory of administration. Bernard divided organization into two types – formal, informal. Drucker's contributing have made tremendous impact on the management practices.

#### 4.4 KEY WORDS :

Scientific Method : Approach through Scientific Principles.

Principles of Management: Henry Fayol has given fourteen general guidelines to the practice of management.

Behaviour : Behaviour is what a persons does it depends on the personality of a person and his environment.

#### 4.5 SELF - ASSESSMENT QUESTIONS :

1. Discuss Taylor's contribution to Management.
2. Explain Merits and criticism of Scientific Management.
3. Discuss Henry Fayol contribution to Management.
4. Explain contributions of Bernard and Drucker to Management.

#### 4.6 REFERENCE BOOKS :

1. Management : Harold Koontz, Cyril O'Donnell
2. Principles of Business Management : Sherlekar & Sherlekar.
3. An Introduction to Business Management : S.C.Asthana ; C.P.Misra
4. Perspectives of Management : Y.V.S.Prasada Rao ( CDE )
- 5.Principles and Practice of Management : L.M.Prasad.

**Dr. K.Kanaka Durga**

## Lesson-5

# MANAGEMENT BY OBJECTIVES ( MBO )

## 5.0 Objectives :

The objectives of this lesson are to-

- know the concept of MBO
- know the process, merits and demerits of MBO

## Structure :

- 5.1 Introduction
- 5.2 Concept
- 5.3 Features
- 5.4 Process
- 5.5 Merits or Benefits
- 5.6 Problems or Limitations
- 5.7 Pre requisites for installing MBO programme
- 5.8 Summary
- 5.9 Key words
- 5.10 Self - Assessment Questions
- 5.11 Reference Books

## 5.1 INTRODUCTION :

Management By Objectives ( MBO ) has gained immense popularity during the past decades. “Peter F.Drucker” has pioneered the concept of MBO. According to him, objectives are the ends and means of an enterprise, all the activities must be framed and directed to perform objectives and no deviations from the achievement of objectives is permitted. There should be a great concern and commitment towards objectives throughout the organisations at any level, then only organisations can survive. It means organisations are to be managed in such a way to achieve the objectives. Hence this concept has gained immense popularity all over the world. In India also, in many organisations, MBO has become the way of management process.

## 5.2 CONCEPT :

MBO is both a philosophy and approach of management. It is a process where by superiors and subordinates jointly identify the common objectives, set the results that should be achieved by

the subordinates assess the contribution of each individual, and integrate individuals with the organisation so as to make best use of organisational resources.

‘ **Koontz** ’ **defined MBO as** – “ MBO is a comprehensive managerial system that integrates many key managerial activities in a systematic manner consciously directed towards the effective and efficient achievement of organisational objectives “. It emphasizes the importance and operation of MBO .

‘ **S.K. Chakra borthy** ’ **opined** – “ MBO is a result- centered, non specialist operational managerial process for the effective utilisation of material, physical, and human resources of the organisation by integrating the individual with the organisation and organisation with the environment.

### **5.3 FEATURES OF MBO :**

Based on the definitions of MBO its features can listed out as follows :

- a) MBO is an approach and philosophy to management and not merely a technique. It is likely to affect every management practice in the organisation. It employs several techniques but it is not merely the sum total of all these techniques. Thus it is a particular way of thinking about management.
- b) MBO provides the stimulus for the introductions of new techniques of management and enhances the relevance and utility of the existing ones.
- c) MBO is the joint application of a number of principles and techniques, and works as integrating device.
- d) The basic emphasis of MBO is on objectives, it tries to match objectives and resources.
- e) This process clarifies the role very sharply in terms of what one is expected to achieve.
- f) Periodic review of performance is an important feature of MBO.
- g) Objectives in MBO provide guidelines for appropriate systems and procedures For instance resource allocation, delegation of authority etc., are determined on the basis of objectives.

### **5.4 PROCESS OF MBO :**

The process of management by objectives translates organisational objectives into individual objectives with the commitment and participation of employees. It improves the clarity and balance of the objectives and makes rigorous analysis throughout the organisation. Following are the steps in MBO process.

#### **a) Establishment of organisational objectives :**

The first basic step in MBO is the definition of organisational purpose and objectives. Basically organisational objectives are to be formulated with the interaction of planning premises. Planning premises refer to the environment in which future plans will operate. The manager has to

assume the future environment and should set the objectives accordingly. The objectives must be made clear as long term and short term objectives, and corporate and departmental objectives.

**b) Identification of Key Result Areas ( KRAs ) :**

Key result areas refer to departments or divisions or elements or functions of an enterprise which play a vital role in the achievement of stated objectives. They are to be identified keeping in view planning premises and corporate objectives. For example KRAs applicable to most of the business organisations are

- Ø Profitability
- Ø Market Standing
- Ø Innovation
- Ø Productivity
- Ø Worker performance
- Ø Resources
- Ø Research & Development

The KRAs are not constant, they vary periodically according to changing conditions and demands. They also change from organisation to organisation, depending on its philosophies and characteristics.

**c) Determination of Subordinates objectives :**

The organisational objectives are achieved through individuals. Therefore, each individual manager must know in advance what he is expected to achieve. Objectives are to be translated into superior's objectives after designing an appropriate organisation with required authority and responsibility. Then superior attempts to decide subordinates objectives with the participation of concerned subordinate. Because the basic concepts of MBO are interaction and mutual acceptance, which increase commitment towards, achievement of objectives.

**d) Matching Resources with Objectives :**

When objectives are set carefully, they also indicate the resource requirement. In fact, resources availability becomes an important aspect of objective setting, because it is the proper application of resources which ensures objectives achievement. Therefore there should be matching between resources and objectives.

**e) Performance Evaluation :**

After establishing the goals of subordinates, their performance can be reviewed periodically by the superiors, and necessary corrective measures and assistance may be provided by the superiors, like the suggestions, quality maintenance, etc., Further, new inputs like training and development, incentives, additional facilities and infrastructure can be furnished in order to see that the final performance must match the objective standards.

### f) Recycling :

Though appraisal is the last aspect of MBO process, it is used as an input for recycling objectives and other actions. In the MBO process, since all the stages are inter-related, the outcome of appraisal at one level is recycled to the higher level to see that objectives are to be performed. For instance when subordinate's objectives are changed after the consultation, then superior's objectives are to be redrafted. i.e., either increased or decreased to match subordinates objectives, or the organisation structure is to be changed.

**Following figure shows the steps in the process of MBO .**

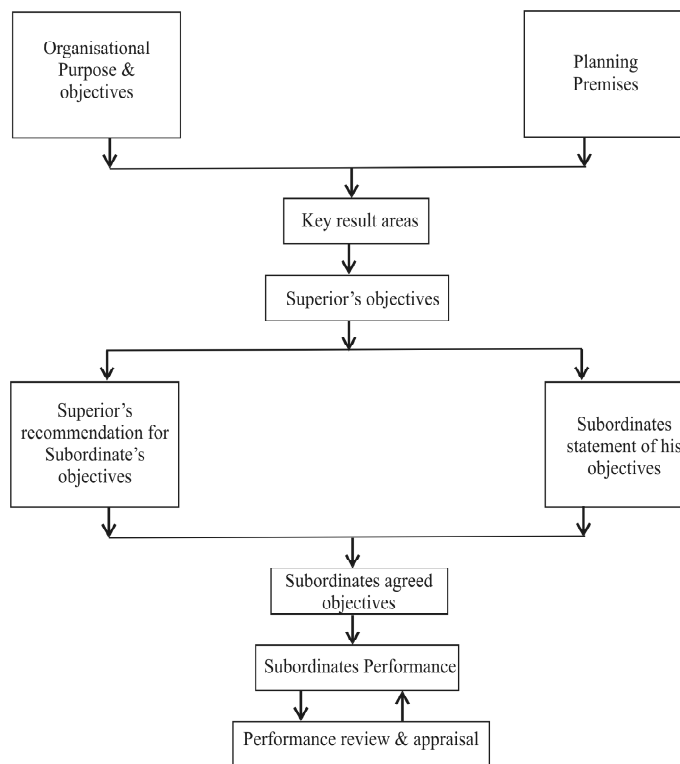

## 5.5 Benefits or Merits of MBO :

### 1. Better Managing :

MBO helps in better managing the organisational resources and activities. Resources and activities are put in such a way that they result into better performance. MBO tries to improve performance in the five ways.

- a. The relationship between clarity of objectives and improvement of performance is the cornerstone of MBO Philosophy.



- b. Clarity of roles, including the areas of authority and responsibility, leads to improved performance.
- c. Periodic review provides opportunities for taking stock of the situation and planning future course of action.
- d. Participation by managers in the management process is expected to ensure achievement of objectives.
- e. MBO provides a base for the philosophy that there is always scope for improved performance.

All these factors for performance improvement are generated if MBO is followed properly.

## **2. Clarity in organisational Action :**

MBO tends to provide the key result areas where organisational efforts are needed. For instance A key factor in objective setting is the external environment in which the organisation operates. Therefore any change in environmental factors is taken care of at the level of objective setting itself. Thus it provides basis for long range planning in the organisation.

## **3. Personnel Satisfaction:**

MBO Provides greatest opportunity for personnel satisfaction. This is possible because of two closely related phenomena :

- i. Participation in objective setting.
- ii. Rational performance appraisal.

In fact in many organisations, people do not perform to the level of their potential because of absence of these positive factors and often there is high rate of managerial turnover.

## **4. Basis for organisational change :**

MBO stimulates organizational change and provides a frame work and guidelines for planned change, enabling the top management to initiate, plan, direct and control the direction and speed of change.

## **5.6 Problems and Limitations of MBO :**

Some of the common problems of MBO are as follows :

### **1. Time & Cost :**

It is a process which requires large amount of the most scarce resource in the organisation and time of the senior managers. Sometimes managers get frustrated and feel overburdened.

### **2. Failure to teach MBO Philosophy :**

Managers often fail to understand and appreciate this new approach. MBO demands rigorous analysis as an integral element of the management process but the organisation may not be used to rigour.

### 3. Problems in Objective Setting :

Setting of verifiable objectives is difficult atleast in some areas. Objectives are more in the form of statement rather than in quantitative form.

### 4. Emphasis on short - term objectives :

Some times , in order to be more precise there is a tendency to emphasise on short-term objectives usually for a year or even less. There is a danger in emphasizing short - term objectives at the cost of long terms objectives.

### 5. Inflexibility :

In a dynamic environment, a particular objective may not be valid for even, in the context of revised objectives, changed premises, it is useless to follow the old objectives. Thus inflexibility created by applying MBO may cause harms.

### 6. Frustration :

Sometimes MBO creates frustration among managers, because it tends to arouse high expectations for rapid change, particularly among the young and junior managers.

Inspite of these obstacles MBO continues to be a way of managing the organisation. Problems of MBO can be over come by implementing it properly.

## 5.7 PREREQUISITES FOR INSTALLING MBO PROGRAMME :

Some of the prerequisites for installation of MBO programme are.-

1. Purpose of MBO should be clearly defined.
2. Top management support for using objectives to plan and to control is essential.
3. Systematic training is required in the organisation for disseminating the concepts and philosophy underlying MBO.
4. Success with MBO requires a commitment on the part of each individual involved in this type of system.
5. Feedback is an essential ingredient in sustained learning and improvement in situations.
6. It must be carried all the way down to the first line of the organization .

## 5.8 SUMMARY :

In this lesson it is attempted to elucidate the process of Management By Objectives. It is a means rather than an end. It has to achieve certain things in the organisation, it has to solve some problems.

## 5.9 KEY WORDS :

Flexibility : Ability to change according to changing conditions.

Periodic review : Review of work from time to time.

**5.10 SELF - ASSESSMENT QUESTIONS :**

1. Define the concept of MBO
2. What are the Features of MBO?
3. Explain the process of MBO.
4. Describe the benefits and problems of MBO.

**5. 11 REFERENCE BOOKS :**

1. Principles and Practice of Management – L.M. Prasad.
2. Management – Harold Koonty  
Cyril O'Donnell.

**Dr. K.Kanaka Durga**

## LESSON - 6

# “ ROLE OF MANAGEMENT –CONCEPT OF BUSINESS ORGANISATION-GOALS-ACTIVITIES”

### 6.0 OBJECTIVE :

On completion of this lesson you should be able to understand,  
role management in business  
concept of business organisation  
goal and activities of management.  
characteristics of business organisation.

### STRUCTURE:

- 6.1 Introduction
- 6.2 Role of Management
- 6.3 The Management Process
- 6.4 Concept of Business Organisation
- 6.5 Essential characteristics of Business Organisation
- 6.6 Factor influencing the choice of suitable form of Organisation.
- 6.7 Goals and Objectives of Management
- 6.8 Management activity
- 6.9 Summary
- 6.10 Self- Assessment Questions
- 6.11 Reference Books

### 6.1 INTRODUCTION:

There is considerable confusion in the use of the words “ Administration” ‘Management ‘ and “Organisation”. These words are used by different people and often by the same person as if they were all synonymous

Organisation is the process of combining the work which individuals or groups have to perform with the facilities necessary for its execution that the duties, so formed provide the best channels for the efficient, systematic, positive and co-ordinated application of the available effort. Further organisation is a mechanism through which people concerned are made to work to achieve the set goals of that enterprise together.

### 6.2 ROLE OF MANAGEMENT :

Management is a process concerned with planning executing and controlling the activities of an enterprise. Managerial behaviour must be goal - directed which results in a succession of activities and events by which the organisation work proceeds. Management is concerned with evolving workable plans which are then put into action resulting in certain consequences which have to be observed and evaluated and constantly compared with the objectives prescribed in the plan. This cyclical process can be described as the management process. It is basically concerned with interrelationship of people at work although it has its base in nonhuman elements , such as machinery technology and physical property.

### 6.3 THE MANAGEMENT PROCESS:

Thinking of Management as a process indicates that it is concerned more with directing performance rather than with doing or working directly on products or services, that is, performing non-managerial work activity must be delegated to non-manager. This should not mean that every manager performs only managerial activities. In actual practice, the manager performs two types of work, namely, the doing aspect or non-managerial work and the managing part of his duties. For example, many managers perform the work of interviewing candidates which is a non-managerial activity. However, from doing to managing often presents an enormous gap.

### 6.4 CONCEPT OF BUSINESS ORGANISATION :

A business undertaking is an institutional arrangement to conduct any type of business activity. The undertaking may be run by one person or association of persons. It may be based on formal or informal agreement among persons who undertake to run the concern. According to Wheeler, a business undertaking is a concern, company or enterprise which buys and sells, is owned by one person or a group of persons and is managed under specific set of operating policies. The persons join to gather and pool their resources and conduct the activities of the undertaking for the benefit of all.

### 6.5 ESSENTIAL CHARACTERISTICS OF BUSINESS ORGANISATION:

**1. Social Responsibility :** The only and one aim of business undertakings is not to increase profits. They own some responsibility to the society also. The society expects business undertaking to provide cheap and better quality goods to consumer. They are also expected to contribute towards social amenities by opening schools, hospitals, parks etc, not only for the employees but also for people living in those facilities

**2. Profit Motives:** All business undertakings are run to earn profits. An undertaking started for social service will not be called business undertaking because the aim is not to earn profit. The incentive of earning profit keeps undertaking going. The aim is to get back more than what has been invested

**3. Dealing in Goods and Services :** All business undertakings deal in goods and services. The goods, may be consumer goods or producer's goods. The consumer goods are those which are purchased by them for consumption or day to day use.

**4. Continuity of Transactions :** The Transactions in a business undertaking are continuous or regular. They are engaged in a series of successive transactions over time and space.

**5. Risk and uncertainty :** Every business undertaking is exposed to risks and uncertainties. Business is influenced by further events and further is always uncertain. There are chances of price fluctuations, demand changes, consumer likings and dislikings etc. There may be fire, earthquake, strike by workers etc,. All these factors make a business undertaking risky and uncertain.

### 6.6 FACTORS INFLUENCING THE CHOICE OF SUITABLE FORM OF ORGANISATION:

**1. Nature of business activities:** The nature of business is an important factor affecting a

decision about the firm or organisation. If a concern deals with local market, a seasonal product or perishable goods, then sole-trade business will be suitable. The capital requirements of such concerns will be less and scale of operation will be low.

**2. Relationship between ownership and management:** There is a direct relationship between ownership and management in sole-trade concern and partnership firms. In company form of organisation, management and ownership are in two different hands. The owners(Shareholders) are spread all over the country and they do not take active interest in the working of the enterprise. Therefore only sole-trade and partnership forms are suitable for above relationship.

**3. Managerial Needs :** Managerial and administrative requirements also affect the decision about form of organisation. When the concern is small and it caters to local needs only then one person will be enough to manage the business. Sole - proprietorship form of organisation will be suitable for such a business. If business caters to more areas, then more persons will be needed to look after various business functions. When a business is run on a large - scale basis, it will require the services of specialists to manage various departments. The company form of organisation will be suitable for such concerns.

**4. Tax Liability :** A joint stock company has more tax liability as compared to a sole - trade business and a partnership firm. A company faces double taxation liability. A company is taxed as an individual first and the profit distributed to shareholders are again liable for tax as income of the recipients. A partnership concern and a sole-trade business are not separately taxed. A small-scale concern will be able to avoid higher tax liability.

**5. Continuity :** This is another factor influencing a decision about the form of ownership. If the concern is stable and there is no fear of discontinuity it will attract more investment. The trained and qualified persons will like to join the concern. The only company form of organisation is the only form which ensure stability and continuity.

**6. Capital Requirement :** The need for capital will depend upon the nature of business and scale of operators. A manufacturing concern may require more capital or compared to a retail shop . On the other hand, if scale of operations is large then, capital requirements will also be more. After determining the capital needs the form of organisation should be selected.

**7.Flexibility :** A good form of organisation should also provide for flexibility in its operations.

**8. Easy in formation :** The nature and extent of formalities required at the time establishing a concern also influence a decision about the form of organisation.

**9. Liability :** In sole - trade and partnership business, the liability of owners is unlimited. In case of companies the liability of shareholders is limited to the value of shares they have purchased.

## 6.7 GOALS AND OBJECTIVES OF MANAGEMENT:

**1.Planning for Future :** Every management thinks and plans about future. The current as well as future planning go together. The activities to be undertaken in future will be planned at present. No concern can survive if it does not plan for future. The likely business trends, future global trends, likely business laws, changing consumer preferences, impact of social changes are the factors which will be taken into account while planning for future.

**2. Better Quality Goods :** The consumer has become quality conscious now. He will go to for only those products which are of good quality and satisfy his needs. At present, the survival of a unit is linked to the quality to products it produces. The objective of the management is to bring out quality products so that they are accepted by the market. It will require introduction of quality standards in the business. Management should make efforts to plan production process in such a way that only quality products are produced and marketed.

**3. Proper utilisation of Resources:** Every management aims to utilise enterprise resources properly and economically. The proper use of men, materials and machinery will ensure reasonable cost and adequate profits. It is not only the management which will look towards business profits but other interest groups such as employees, shareholders, customer, government will also be affected by its quantum. The efforts of the management should be to make optimum use of available resources in order to achieve better results.

**4. Growth and Development of Business:** Managerial efforts to be expand and diversity the business. If there is a scope to expand the existing business then efforts should be made to develop it but avenues to enter new avenues should also be explored. It will give stability and strength to the business.

**5. Mobilising best talent :** The management should try to employ proper persons in various fields so that better results are possible. The employment of specialists in various fields will be increasing the efficiency of various factors of production. There should be proper environment which should encourage good person`s to join the enterprise. Better pay, scales, proper amenities, future growth potentialities will attract more people in joining the concern.

**6. Promotion of Research :** The greatest drawback in India business is its lack luster approach towards research. Management give hardly any importance to research activities. It restrict their strength and capacity to compete in the market. There is a need to keep oneself aware of what is going on in the market and prepare to face it. The promotion of research is the only answer at present. Management should always try to get benefits of latest technological changes and ready to face the future with confidence and zeal.

**7. Minimising risk element:** Every business at present is facing global competition. The products from developed countries are flooding markets in India. There is a need to improve overall working for staying in such a competition. The management should plan the activities in such a way that business is able to survive, under uncertain conditions. There is a need to minimising risk element and also to explore newer and better avenues.

## **6.8 MANAGEMENT ACTIVITIES :**

From the goals at management , it is clear that management consists of getting things done through others by directing their efforts in an integrated and co-ordinated manner in order to attain business activities. It consists of resources. It consists of all organisational activities that involve goal formation and accomplishment, performance appraisal and the development of an operating philosophy that ensures organisational survival. An analysis of the above things the management indicates the following activities.

**1. Management is an activity:** It is a process of organisational activity which is concerned with the efficient use of resources of production. Resources include material, money and people in the organisation.

**2.It is a purposeful activity:** It is concerned with the achievement of an objectivity through its functions such as planning, organising, staffing, directing and controlling. Objectives may be explicitly defined or implicit.

**3.It co-ordinates all activities and resources:** It is concerned with the co-ordination of all activities and resources through its various functions to attain the state objectives.

**4.It is a universal activity :** Managers, irrespective of the enterprise in which they are working and their place in the organisation structure, make use of the management principles. It means that the techniques and tools of management are universally applicable.

**8.It is an integrating activity:** It integrates men, machines and material for carrying out the operations of an enterprise and for achieving the stated objectives. It is said that the task of business management is the responsibility for welding into a single working force the three factors men –men, method and machinery.

**9.It is a profession :** Gradually, it is becoming a profession because there are established principles of management which are being applied in practice.

## 6.9 SUMMARY:

1. The concept of management has become universal and no organisation can survive without it. Management consists of getting things done through other by directing their efforts in an integrated and co-ordinated manner for achieving the business objectives.

2. The basic aim of managing is to achieve certain objectives and goals. The manager must be sure of the objective or objectives be desire to attain or of the end result to be ensured.

3. Selecting a suitable form of business organisation is very important decision as it is very difficult to change the form of organisation looter on. We have mentioned above the factors that influence the form of organisation.

4. Management plays a vilal role in modern society. It regulates man's productive activities by organising factors of production management is needed not only for business concerns but also for social organisations, like educational, religious, charitable and other non business institutions.

## 6.10 SELF - ASSESSMENT QUESTION (ESSAY TYPE ):

1. Discuss the role of management in business organisation
2. Define the concept of business organisation? explain the essential characteristics of business organisation
3. What factors influencing the choice of suitable form of business organisation.
4. Define management process and explain the goals and objectives of management
5. What is the meant by management activity ? explain the various activities

## 6.11 REFERENCE BOOKS:

1. Agarwal : *Organisation and Management*, TATA Mc Graw Hill, New Delhi 2003
2. J.S. Chandan ; *Management Theory and Practice*
3. R.K. Sarma & S.K. Gupta; *Industrial Organisation and Management*, Kalyani Publishers, New Delhi, 2003
4. Rustam S. Dallar : *The Management Process*; Progressive Corporation Pvt Ltd, Bombay 1978.
5. DeGeorge, R.T; "*Business Ethics*", Mc Millan, 1982

**Dr. D. NAGESWARA RAO**



## Lesson- 7

# ROLE AND RESPONSIBILITIES OF TOP, MIDDLE AND LOWER LEVEL MANAGERS

## 7.0 OBJECTIVE:

In this lesson you should be able to understand:

- \* level of management
- \* role, functions and responsibility of top management.
- \* role, functions and responsibilities of middle management
- \* role, functions and responsibility of lower management

## STRUCTURE:

- 7.1 Introduction
- 7.2 Levels of Management
- 7.3 Role and Responsibility of Top Level Management
- 7.4 Functions of Top Level Management
- 7.5 Role and Responsibility of Middle Level Management
- 7.6 Functions of Middle Level Management
- 7.7 Role and Responsibility of Lower Level Management
- 7.8 Functions of Lower Level Management
- 7.9 Effective Supervision
- 7.10 Summary
- 7.11 Self - Assessment Questions
- 7.12 Reference Books

## 7.1 INTRODUCTION:

There are basically three levels of management with relative standing in an organisations hierarchy. The top level of management includes top executives such as chief executive officer, chief operating officer, president executives and various vice-presidents. The middle management level generally consists of divisional and departmental heads. Further, the lower management consists of superintendents units heads, foremen etc.

## 7.2 LEVEL OF MANAGEMENT :

The process of dividing authority and responsibility among the various executives is called the creation of levels of management. In other words, it is concerned, with the classification of superior- subordinate relationship in an organisation. There is no fixed number of management levels prescribed for a particular organisation and this depends, to a certain extent, on how they are defined and classified the nature of organisation, size of enterprise etc., Further, there is no unanimity among the writers in this respect. Keith Davis has classified various management levels as trusteeship management, general management, departmental management, middle management and supervisory management. **Koontz, O. Donnell** and **Brech** have classified the levels into two viz, top level management and supervisory level management.

Thus there is no unanimity among the writers. For the convenience of study, the levels of management may be classified into three groups (1) top management (2) middle management and (3) lower management. The various positions which are included in each level of management may be seen in the following chart.

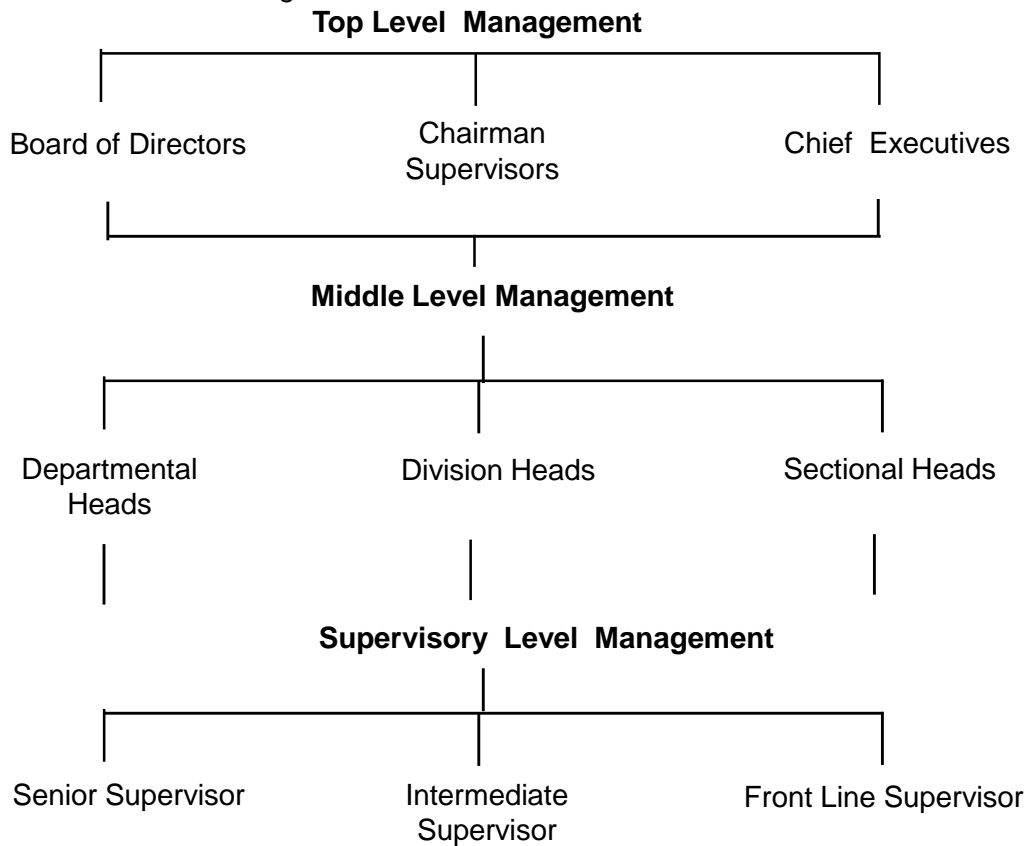

### 7.3 ROLE AND RESPONSIBILITIES OF TOP LEVEL MANAGEMENT:

Top management is at the head of the organisation. It consists of the Board of Directors and its Chairman, the Chief Executive (Ex., Management Director or General Manager) and the Senior Executive (viz, Deputy General Manager). In the operation of the enterprise, top management is the ultimate level of authority. Further, these top level managers are primarily involved in broad organisational matters such as policy formulation, long range planning, goal the top management of organisational strategies. In general, the top management effectively deals with all elements and forces that affect the survival, stability and growth of an organisation.

In the words of **B. Yuill**, the top management duty to protect the integrity of the organisation, so that it can survive for its own employees, the shareholders, suppliers and the customer's interests and for the general good of the social and economic system within which it operates.

### 7.4 FUNCTIONS OF TOP LEVEL MANAGEMENT:

The main functions of top management are as follows:

**(a) Determine objectives for the organisation :** Objectives may relate to profit, business growth, survival, prestige, competitive pricing, marketing method, widening the area of sales, relations with workers, customers, public etc.

**b) Frame the policy :** To frame the policies and chalk out the plans to carry out the objectives and policies. Policies may relate to different aspects of the organisation. For example, production policy deals with the quality, product variety, scheduling of production to meet the market demand etc.

**1) Marketing policy :** This policy deals with such matters as advertising and sales promotion techniques, pricing the product, channel of distribution, commission, discounts, placement, training, remuneration promotion, appraisal of performance etc. of the personnel.

**2) Financial policy :** This relates to the procurement of funds, source of finance, management of earning etc.

**c) Organisational Frame work:** Top management determines the organisational structure for the purpose of executing the plans that have been laid down. Execution of plans is necessary to carry out the objectives and policies.

**d) Assemble the Resources :** For the purpose of executing the plans, the resources of men, machines, materials and money have to be assembled. This again is the task of top management.

**e) Control the operations through organisation :** Controls the top management regarding operations through budgets, cost and statistical quality control and accounting devices.

## 7.5 ROLE AND RESPONSIBILITY OF MIDDLE LEVEL MANAGEMENT:

Middle management consists of departmental, divisional or sectional heads and other executive officers attached to the different departments. This level of management is responsible for implementing the policies and plans decided by the top management. Middle management comes between the top management and the supervisory management. According to **Mary C. Niles**, middle managers have pressures from the corners, viz., (a) from above by his chief in top management with whose ideas, policies and attitudes he must agree (b) from below by the supervisors who press for counsel guidelines, decisions etc. and (c) sideways by colleagues whose departments or functions or activities are interrelated with its own.

## 7.6 FUNCTIONS OF MIDDLE LEVEL MANAGEMENT:

According to **Mary C. Niles** middle management acts with and under the top management to accomplish who following broad objectives of administration.

- i) To execute the various functions of organisations, so that the top management gets enough time to look after their responsibilities.
- 2) To co-operate among themselves, will the top management and the supervisors so that the organisation functions smoothly.
- 3) To understand the interlocking of departments in major policies.
- 4) To achieve co-ordination between the different parts of the organisation
- 5) To develop and train employees in the organisation for better functioning and for filling up vacancies that may arise in future.
- 6) To build company spirit where all are working to provide a product or survice wanted by the public.

## 7.7 ROLE AND RESPONSIBILITIES OF LOWER LEVEL MANAGEMENT:

Supervisory management (lower level management) consists of senior supervisor. Supervisory management is above the operatives but below the middle management in the organisation. The executives at this level are in direct touch with the rank and file of workers and have to see that the work is properly carried out. The personnel employed at this level play an important role in the

organisation. The effective implementation of the plans and policies, the quality of workmanship quality of output and over all success of the organisation very much depend on the hard labour, discipline and loyalty of the personnel at this level of management. Further, this level of management represents the workers before the higher management and the higher echelons of management to the workers.

As the supervisor is the immediate boss of the workers, the workers look to him for orders policies, instructions, guidance, encouragement, increased pay etc. The success of the supervisor depends on the preference of the workers, their co-operation, their ungrudging effort, their satisfaction and their loyalty to him. The supervisor in turn looks to his superior in middle management for orders, policy information, help and guidance.

### **7.8 FUNCTIONS OF LOWER LEVEL MANAGEMENT:**

The various functions of supervisor are as follows

- 1) To issue orders and instructions to the workers and to supervise and control their work.
- 2) To plan the activities of his section.
- 3) To classify and assign jobs to the workers
- 4) To direct and guide the workers about work procedure.
- 5) To arrange for the necessary tools, equipment, materials etc., for the workers
- 6) To arrange for providing on-the-job training to the workers.
- 7) To look after the proper maintenance of tools, machinery etc.
- 8) To solve the problems of workers
- 9) To inform the management about the problems of workers which are not solved at this level.
- 10) To advise middle management about the working environment and to act as liaison between the middle management and the rank and file workers
- 11) To maintain discipline among the workers and to develop in them the right approach to work.
- 12) To maintain good human relations.
- 13) To build a high group morale among the workers

### **7.9 EFFECTIVE SUPERVISION :**

Effectiveness of a supervision is judged how he is contributing to his organisation by his work for achieving the organisational objectives. Some of the important elements of effective supervisory practice are:

- a) Leadership
- b) element of supervision
- (c) employees orientation of human relations
- (d) group cohesiveness
- (e) delegation
- (f) satisfying the needs of subordinate for promotion and recognition
- (g) providing work – centred benefits to subordinates
- (i) informing the subordinates about their duties and relevant organisational matters and
- (j) presenting model behaviour to the subordinates.

### **7.10 SUMMARY :**

There are no fixed levels of management. Further, there is no unanimity among writers in this respect. For the convenience of study, the levels of management may be classified into three groups. (a) top management (b) middle management and (c) lower or supervisory management. Top management consists of the Board of Directors and its Chairman, the chief executive and the senior executives. Middle management consists of departmental, divisional, or sectional heads and other executive officers attached to the different departments. Supervisory management consists of senior, intermediary and front line supervisors.

Top management decides the plans and policies, middle management is responsible for

implementing the plans and policies and the supervisory management has to see that the work is properly carried out.

### **7.11 SELF-ASSESSMENT QUESTIONS (ESSAY TYPE):**

1. How will you classify the levels of management? Briefly describe the fractions of the different level of management.
2. What is meant by top management? Explain the responsibility and functions of top management.
3. Define middle management? Explain the responsibilities and functions of middle management.
4. Explain the supervisory management level? What are the responsibilities and functions of supervisory management.

### **7.12 REFERENCE BOOKS:**

1. R.K Sarma \ Shashi K.Gupta, *Industrial Organisation and Management*, Kalyani Publishers, New Delhi, 2003
2. J.S. Chandan , *Management Theory and Practice*, Vikas Publishing House Pvt Ltd, New Delhi, 2004.
3. V. Surendar and others, *Industrial Organisation and Management*, Himalayas Publishing House , Delhi, 2001

## **LESSON - 8**

# **Functional Areas of Management**

### **8.0 OBJECTIVE:**

After completion of this lesson, you should be able to understand about-

- \* importance of functional management
- \* finance manager
- \* production manager
- \* human resource manager
- \* office manager
- \* information resource manager

### **STRUCTURE:**

- 8.1 Introduction**
- 8.2 Financial Manager**
- 8.3 Responsibilities of Financial Manager**
- 8.4 Functions of Financial Manager**
- 8.5 Production Manager**
- 8.6 Importance of Production Planning and Control**
- 8.7 Product Design Manager.**
- 8.8 Human Resource Management**
- 8.9 Human Resource Manager**
- 8.10 Qualifications of H.R.M.**
- 8.11 Qualities and Responsibilities**
- 8.12 Office Management**
- 8.13 Office Manager**
- 8.14 Duties and Responsibilities of the Office Manager**
- 8.15 Functions of Office Manager.**
- 8.16 Information Resource Manager**
- 8.17 Functions of Information Resource Manager**
- 8.18 Summary**
- 8.19 Self-Assessment Questions**
- 8.20 Reference Books**

### **8.1 INTRODUCTION:**

Common process of management is required to achieve the objectives of a business undertaking. Well planned activities can be performed through a common process of management. The main operating units of an undertaking are usually three- purchase, sale and storage (under production segment). But to this financial and accounting units are also added. In order to limit the managerial activities within well defined cohesive limits and for sound and easier management. The management process is divided into different functional areas. The U.K Education Ministry has divided the functions areas of management into nine viz:

1. Production Management
2. Financial Management
3. Development Management
4. Distribution Management

5. Purchasing Management
6. Transport Management
7. Maintenance Management
8. Personnel Management
9. Office Management.

## 8.2 FINANCIAL MANAGEMENT:

The financial manager related to the management of finances of the organisation in a manner in which he yields the maximum return with lowest investment. Finance is an important function of any business as money is required to purchase raw materials and machines to pay wages and salaries, to allow credit facilities and so on.

Financial management is a survive function so far as the business and industrial enterprises are concerned. It is an operating function for a financial institution.

## 8.3 RESPONSIBILITIES FOR FINANCIAL MANAGER IN THE FIRM:

Financial management in many ways is an integral part of the jobs of managers who are involved in planning, allocation of resources, and control. The responsibilities for financial managers are dispersed throughout the organisation.

1. The engineer, who proposes a new plant, he shapes the investment policy of the firm
2. He supervises, whether the marketing analyst provides inputs in the process of forecasting and planning.
3. He influences the purchase, whether the of investment in inventories
4. Financial and departmental managers, in general are important links in the financial control system of the firm.

## 8.4 FUNCTIONS OF FINANCIAL MANAGERS:

The following functions should be observed

- a) Economic and Financial Forecasting
- b) Accounting and auditing
- c) Cost control
- d) Budgetary control
- e) Data collection and control
- f) Identification of the problems of capital ,cost and financial control and find out their solutions.

## 8.5 PRODUCTION MANAGEMENT X MANAGERS :

As in case of other functional areas, managers incharge of the production function are required to take major policy decisions and apply the principles of management to their function. In fact the first applications of management principles were in the area of production, particularly because production easily lent itself to qualification. In the Indian Context also,as most of the goods are in the sellers market although the trend has been changing recently, top management thinking naturally become more production-oriented rather than marketing oriented. Thus, there was greater emphasis on production. Planning and Control with a view to reduce costs and improve quality.

## 8.6 IMPORTANCE OF PRODUCTION, PLANNING AND CONTROL:

In a developing economy like India, importance of production, planning and control cannot be ignored. In any country which is still infancy or is on the road of its production. Planning has a

definite role to play. In a continuous process of industrial production is usually small in size and its producer of production is quite simple.

### **8.7 PRODUCT DESIGN MANAGERS :**

Success or failure , to a great extent, depends upon product design manager of a enterprise. Product design is as important is not so easy considerations such as simplification and standardisation, reliability, sustainability etc., help in deciding a good product design. Production design starts where product design ends. Production design mainly involves scheduling and product inspection.

Quality is the performance of the product as per the commitment made by the producer to the consumer quality of produce is Critical to success. Therefore, quality needs to be controlled/ maintained. The popular methods of quality control are inspection and statistical quality control. In India, the Bureau of Indian standards has been doing a Yeoman Job in controlling quality of a large number of production.

### **8.8 HUMAN RESOURCE MANAGEMENT :**

You have already learn that those who run an enterprise have to manage many resources to accomplish their business goals. They may purchase raw material invest in plant and equipment , build a building and arrange for cash flows. No doubt all these decisions are of great importance in accomplishing business objectives.

Enterprises are run by man. In order to have manpower in required quantity and quality. The first task involved in this process is planning for manpower. Manpower planning is a process by which an enterprise ensures that it has the right number and kind of people with appropriate skills , at the right place and right time to do the enterprise work.

### **8.9 HUMAN RESOURCE MANAGER :**

Human resource manager is one of the many specialists, who has been appointed in the organisation as a result of the growth of the organisation. He is assigned the personnel function like recruitment, selection, wages and salary, administration, promotion etc. The personnel department gives assistance or provides services to all other departments on the personal matters. Human resource manager functions are line functions when he is directly responsible for wage, administration, time office, canteen, induction, training and for day to day negotiations with the union. But in relation to all other executives his position is of an advisor and when he provides services to other department his functions are staff functions.

### **8.10 QUALIFICATIONS:**

The qualifications of personnel (human resource) manager must be practical as well as theoretical. Some managers are satisfied with the amount of experience or trained gained by moving from one department to another within the organisation. But it should be remembered that it is only single channel in breeding, which suffers from a lot of defects : therefore it is essential that a personal manager should have sound academic back ground in the fields of personnel management and industrial relations. He should know the various labour and industrial laws. He should be given specific training to appreciate fully the scope of personnel management.

### **8.11 QUALITIES AND RESPONSIBILITIES :**

For a personnel manager the qualities of character and personality, are more important than knowledge. However some of the important qualities required in any successful personnel



manager are.

**(1) sense of vocation :** The responsibilities of the job of the personnel manager are so hardy that they cannot be carried out without some sense of an inner urge. He should have faith in humanity and also in the possibility of creating a better social and industrial order.

**(2) Sense of Social responsibility:** Industry is a part of the society whose success depends upon the effective co-operation of the people working in the industry. He is concerned with creating facilities for getting better co-operation from the personnel.

**(3) Capacity for leadership:** He is a dual role to advise the management on human problems and to exercise leadership in many matters affecting the worker. He should be ready to face opposition and to speak without fear from any level of management and to any group of workers. He should be in a position to convince others about his view points and to provide leadership in the organisation.

**(4) Personnel integrity:** He must be a man who can be trusted completely so that all people of the organisation may come to him with their worries, anxieties and problems. Even the fellow managers and directors should confide in him, their difficulties. He is concerned with human relation problems more than anybody else in the organisation and should be a man great integrity.

**(5)Capacity for persuasion:** This is the intellectual side of leadership. He has to persuade his fellow managers of the wisdom of the proposals he makes. Similarly , he has to persuade the personnel to reconcile with the object of the organisation. He should have the patience to persuade the employees in the desired direction.

**(6) Dynamic Personality:** Besides above mentioned qualities, the personnel manager should possess a dynamic personality with the following characteristics.

- a) **Spontaneity of speech :** Ability to express oneself in accurate terms avoiding misunderstanding.
- b) **Public speech :** It is often a necessity in the working life of a personnel manager.
- c) **Face expression :** Mobility of facial expression is also important for a personnel manager, because it will help him in dealing with the personnel more efficiently.
- d) **Courtesy and social awareness :** He is actually the human relations manager. He has to speak to people of all grades and ranks trade union leaders, workers, representatives. For all these accassions he is better equipped if he possesses a sense of courtesy and social awareness.
- e) **Personal dignity :** He should be able to mix with the people and yet not to be one of them. His job is bigger than himself and this fact must be the measure of his action, rather than any social code of etiquette or standard.

Personnel management being one aspect of general management, it is not possible to frame a uniform type of training in personnel management. In personnel management, the man is more important than his training and the possession of certain qualities of character and personality is required as a condition precedent to appointment of a person on a personnel job.

## 8.12 OFFICE MANAGEMENT :

To administer in ordinary sense of the term “an office is called office management. In broder sense” To conduct, guide, and control the affairs of the organisation. With a view to achieve the pre-determined objectives” is an office management. Office is required to maintain communication and also to arrange the transmission of both internal and external communication and some times is also called upto to (1) select(ii) train (iii) place (iv) promote and (v) remarkable the office personnel. An office is the nerve of the entire organisation from where originates all the decisions.

### 8.13 OFFICE MANAGER:

The modern manager desires to make his decisions based on facts and not on hunch or intuition. An office manager is in charge of organising sources in the form of men, money, materials, machines and methods (Five M's) in such a manner that the office can assure efficient service to all other departments such as production, purchase, sales and finance. The office manager is one who knows how to set other people's heads, heart and hand at work, not only to his profit but also to their profit. Management is an art of getting things done through and with other people office work consists of collecting, processing, recording and communicating information in a form and at a time and place in such a way that proper people receive accurate and timely information when needed.

### 8.14 DUTIES AND RESPONSIBILITIES OF THE OFFICE MANAGER:

The office manager is important because he is a part of management. He is the head of the administrative section. He is one of links in the chain of command from top management. He is the head of the office organisation.

s The duties and responsibilities of the office manager are as follows:

1. He has to see that office work is done properly. This involves supervision and control of office staff.
2. He has to supervise and control all the sections in-charge of various office services viz. mailing communications, filing, recording office stationary and supplies, etc.
3. He is the valuable advisor to the heads of other departments on planning and organising their sectional clerical activities.
4. He should maintain up-to-date office manual of forms and procedures.
5. He should set the policies and procedures for all types of office activities.
6. He should be familiar with organisation and methods studies which can introduce improvements and simplification in the office work.
7. He is in charge of selection and training of subordinates and office employees.
8. He must exercise due care relating to installation of office machines, their repairs and maintains and replacement of machines where necessary.

In short, the office manager has two broad areas of responsibility.

**(i) Human relations :** This means recognition of human values and treating office employees as human beings and not merely as cogs in a machines. Human resources are the fundamental resources of any business. An office manager is also a personnel manager. Human relations include interviewing smoking, absences, grievances , discipline, functionality, dress, delegation, training, motivating etc.

**(ii) Work organisation and methods:** These relate to material resources. They include methods, costing, organisation, checking on occurancy, stationary, office equipment and matching, physical facilities in the office, work output, etc.,

### 8.15 FUNCTIONS OF OFFICE MANAGER:

Management is the planning, organising and controlling of the total business activities and the directing or motivating(leading) of the people working in the organisation. So that the use of 6 "M" s (money, men, material, machinery, methods and minutes ie., time) results in the efficient achievement of planned goals or objectives.

**1. Planning of office activities :** In the first place an office manager or secretary sets out objectives or goals in each area of office management. He will plan a suitable office layout and necessary organisation structure. A plan of office organisation and management will deal with

four basic factors – objectives, policies, organisation and operation.

**2. Organising office work:** This is the second managerial function of the secretary as an office manager. He will analyse office activities. The work is classified or divided into manageable activities. Then the activities are divided into manageable jobs. Now these units of activities and jobs are grouped into an organisation structure. Office management is not just planning. It includes breathing life into the plan. This is done by bringing together people, material and machines in a proper relationship and all this must be done in time. This task is called organising, organisation enables execution of plans.

**3. Motivating and Directing :** This is the third managerial function of the secretary as an office manager. A manager must have leadership qualities. He has to motivate and communicate. He makes a team out of the people responsible for various jobs. The power of a manager exists with or through people not over them. The secretary can induce people to offer voluntary co-operation in office work by means of incentives and rewards for successful work and by means of a sound promotion policy, proper motivation and leadership alone can set things done through and with other people.

**4. Communicating :** If people understand what is going on around them, seeing eye to eye is not difficult. But in a large office to get employees see things in the same way and at the same time calls for effective communication. The office is the principal tool of communication-constant flow of information, horizontal and vertical ( upward and downwards ) in an organisation. Effective communication is necessary to maintain adequate job knowledge, to carry out methods of instruction and to keep employees up-to-date on current information and possible changes.

**5. Controlling office activities :** This is the fourth managerial function of the secretary as an office manager. He must prepare a budget and live within it. He is accountable for quantity and quality of office work. He has to maintain speed, accuracy and quality of work turned out. He must meet dead lines, i.e., time limits set for doing office work. He has also to control the cost factors of office services. Control is a means to check the execution of plans and apply corrective measures to remove deviations and deficiencies found in the performances of employees.

## 8.16 INFORMATION RESOURCE MANAGER:

No effective decision can be taken and implemented to solve any problem, unless the full information relating to the problem and its surrounding is made available to management. Not only should this information be made available, but it must be made available quickly. The right information at the right time reduces the risk of wrong decisions. The proper collection, handling and providing the necessary information to the right manager as soon as possible could be a tremendous boon to the control function.

## 8.17 FUNCTIONS OF INFORMATION RESOURCE MANAGER:

The information resource manager has been performing the following functions in an enterprise

1. He supplies complete, accurate and timely data, so that he can be used for effective planning and decision making. This would result in elimination of problems associated with inconsistent, incomplete, and inaccurate data
2. He identifies and quantifies the inter-related operational and performance variables and develops a relationship of these variables which can be projected to forecast future trends
3. He facilitates control of present costs by merging the financial and production data to produce measures of performance which can be closely monitored.
4. He identifies the separate needs of all units of a decentralised organisation in a cohesive man-

ner so that these needs can be attended to without duplication and waste of efforts

5. He defining and analyzing various types of decisions that are made, both operational as well as those related to policies within the organisation to keep the organisation going

6. Identifying and isolating the type of data that is relevant and needed for making these decisions.

While there may be different approaches to designing an effective MIS, it is necessary to have a central location for processing all the information. This is a kind of Management Information Center. This center has all the hardware, software and all technical help necessary to gather all information at one location and sort it out, so that the managers can find facts, and turn these facts into management information. This information will be used for decision making. Even though, will this information center, the managers themselves sort out the facts in order to formulate information, as against the information being given to them by their subordinates, the basic philosophy of MIS remains the same.

### 8.18 SUMMARY:

A manager's job is highly crucial to the success of any organisation. The more complex the organisation, the more crucial is the manager's role in it. It is the manager's job to achieve the organisational objectives through the proper utilisation of its human and material resources. However, since the material resources of equipment, capital, facilities information, office management etc. can only be used by humans, the human resources are the most valuable assets of any organisation. Accordingly, a manager must be highly skilled in the art of optimally utilising the human resources. This art is universal in nature. It is used not only in large corporate enterprises but also in other organisations such as schools, hotels, hospitals, retail stores etc. The aim of improved performance and the techniques of achieving this aim are similar. While the field of management can be specialised to suit the needs of a particular environment, some of the characteristics are common to all managers and are universally applicable. For example, a personnel manager at the middle level and the top level are trained in all necessary skills. Thus, a good manager possess the following necessary skills.

1. Technical skills
2. Human skills
3. Analytical skills
4. Conceptual skills

### 8.19 SELF - ASSESSMENT QUESTIONS (ESSAY TYPE):

1. How do manager's different work roles affect his ability to perform as an effective manager?
2. What is meant by functional management? Explain the role, responsibilities and functions of financial manager?
3. Define production management? Explain the importance of production planning and control?
4. What is meant by Human Resource management? Explain the qualifications, qualities and responsibilities of a human resource manager.
5. Define office management? what are the functions, duties and responsibilities of an office manager?
6. Who is a information resource manager? Explain his functions and role in an organisation?

**8.20 REFERENCE BOOKS:**

1. J.S. Chandan; *Management: Theory and Practice*, Vikas Publishing House Pvt Ltd, New Delhi, 2004.
2. K.K. Ahuja, *Personnel Management*, Kalyani Publishers, New Delhi, 2004
3. Prasanna Chandra, *Financial Management Theory and Practice*, Tata Mc Graw - Hill Publishing Company Ltd, New Delhi, 1988.
4. Rustom S. Davar, *The Management Process, The Principles of Management*, Progressive Corporation Pvt Ltd, Bombay -1978
5. S.A. Sherlekar, *Modern Business Organisation and Management- Systems Approach*, Himalaya Publishing House, Bombay, 1982.

**Dr. D. NAGESWARA RAO**

## LESSON - 9

# PLANNING

### 9.0 OBJECTIVE:

The objectives of this lesson are

- \* to know the meaning of Planning
- \* to know the process of Planning
- \* to know the techniques of Planning
- \* to know the significance of Planning etc.,

### STRUCTURE :

- 9.1 Introduction
- 9.2 Meaning of Planning
- 9.3 Concept of Planning
- 9.4 Principles of Planning
- 9.5 Planning Process
- 9.6 Techniques of Planning
- 9.7 Significance of Planning
- 9.8 Limitations of Planning
- 9.9 Summary
- 9.10 Self - Assessment Questions
- 9.11 Reference Books

### 9.1 INTRODUCTION :

Planning concentrates on setting and achieving objectives of an organisation. Planning is the first management function. Before any action is taken place, it is essential to think about planning and design the future course of action, otherwise functioning would be ambiguous and performance of the organisation could not be upto the level of desired standards.

### 9.2 MEANING OF PLANNING :

Every human activity undertaken with a view to achieve something must be preceded by planning. For instance, a student desirous of securing a good grade in the examination has to plan his study. A person intending to set up a business cannot do so unless he has done a lot of previous thinking considered various aspects and taken many decisions if not all. He has to plan within the available resources, the location, the products to be sold, customers to be approached or the markets to be entered.

Managerial operations must be based on suitable and sufficient planning. It has to plan not only in the beginning but throughout the operations.

### Definitions :

“ Planning is deciding in advance what is to be done”

“Planning bridges the gap between where we are to where we want to go”.

“Planning will involve deciding a course of action from amongst a number of alternative courses which would help the enterprise to achieve its objectives most expeditiously and economically.

“Planning ensures proper application of resources for the attainment of desired ends”

### 9.3 CONCEPT OF PLANNING :

Planning is not only the first function of management, it is an integral part of it.

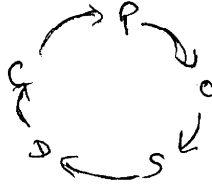

To plan is to look ahead and chart out the future course of operations. It is the determinant of a course of action to achieve a desired result. It is one of the corner stones upon which successful enterprise depends. Planning is meant for the following

1. For the analysis of a problem
2. Thinking out the forward solutions to that problem
3. outlining the steps that must be taken to reach the objectives.

A planner has to think about the following aspects.

- a. What is to be done ?
- b. How it is to be done ?
- c. When it is to be done?
- d. By Whom is it to be done?
- e. Where it is to be done ?

Following chart shows there stages in Planning

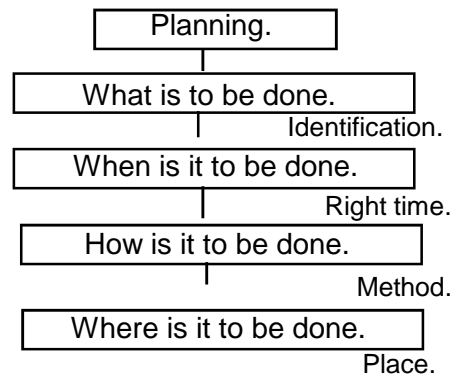

**Figure 9.1. Stages in Planning**

### 9.4 PRINCIPLES OF PLANNING:

**(A) Principle of contribution to objectives :** Both major and derivative plans are prepared to contribute to the objectives of the enterprise. Planning is used as a means to reach the goals.

**(B) Principle of Primacy of Planning :** This principle states that planning is first or primary function of every manager. Other managerial functions are organised to reach the objectives set in planning.

**(C) Principle of Planning Premises :** This principle lays emphasis on properly analysing the situation which is going to occur in future. In order to make planning effective, some presumptions have to be made on the basis of which planning has to be undertaken.

**(D) Principle of Alternatives :** Planning process involves developing of many alternatives and then selecting one which will help in achieving desired business goals .

**(E) Principle of Timing** : Planning premises and policies are useful with proper timing

**(F) Principle of Flexibility** : This principle suggests flexibility in plans if some contingencies arise. The plans should be adjusted to incorporate new situations.

**(G) Principle of Commitment** : There should be a time frame for meeting the commitments made. This will ensure the achieving of targets in time.

**(H) Principle of Competitive Strategies** : while formulating own plans a manager should keep in mind the plans of competitors. The plans should be framed by thinking of what the competitors will do in similar situations.

## 9.5 PLANNING PROCESS:

Planning can be accomplished in a series of steps, it is called as planning process. It starts from perception of opportunities to realisation of opportunities. It determines the future course of action for utilizing resources in the best possible manner to get optimum possible results. The various steps in planning process are described below.

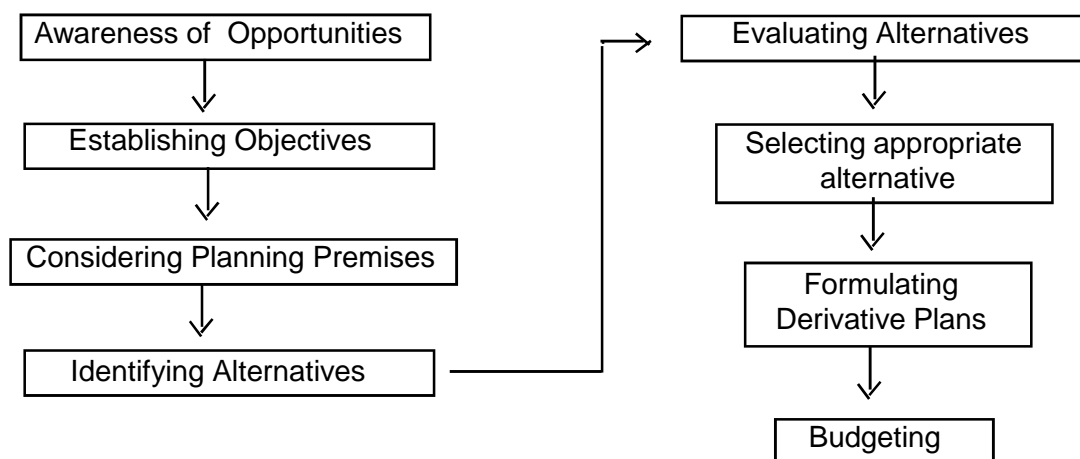

**Figure 9.2: Steps in Planning**

### STEPS IN PLANNING PROCESS:

**i) Awareness of opportunities** : while planning basically managers are needed to know the availability of opportunities to the organisation. Opportunities are available from environment. These are new project can be had from changing needs of customers, technological changes, competitors weaknesses and innovative patterns of the organisation. Awareness of opportunities involves preliminary understanding and estimation of opportunities and analysing them in the light of strengths and weakness of the organisation for the purpose of assuming them. When the managers are utilising the opportunities, it is to be observed they should be free from threats.

**ii) Establishing Objectives** : The second steps in planning is to setup objectives for the enterprise as a whole, and for the departments and individuals. Objectives are to be set for the long run as well as for the short run. These are the end points for managerial course of action and they are the destination for all the activities. Objectives specify the expected results and show how the destination is to be achieved and where emphasis is to be placed.



Objectives of enterprise are to be translated into departmental objectives, and departmental objectives are to be converted into individual goals. Then only overall objectives for which the organisation is established can be achieved. Enterprise objectives give direction to major plans, in turn they are used to setup objectives for lower levels. Objectives appear in different forms, they are mission, overall objectives, divisional objectives, departmental objectives and individual objectives etc.

**iii) Planning Premises :** Once the objectives are determined the next step is establishing the planning premises. planning premises refer to the environmental conditions or surrounding circumstances in which plans work. Plans will operate in future, hence it is appropriate to expect future conditions and should plan accordingly.

**iv) Identifying the Alternatives :** In order to achieve the objectives under expected conditions managers first must identify various alternative courses of action. For instance, to achieve the objectives of securing desired profits, necessary plant and machinery should be established in the organisation. The machinery can be of different types like -

- manual plant
- semi automatic plant,
- complete automatic plant.

These are known as alternatives. While developing the alternatives, organisational frame work like constraint of capital, manpower and philosophies may be taken into account.

**v) Evaluating the Alternatives :** After identifying the alternatives, the following stage is to evaluate their advantages and disadvantages. Their evaluation should be done in the light of the enterprise objectives.

**vi) Selecting a Course of Action :** Choice of a particular alternative is the next step after evolution. Evaluation explains the merits and demerits. Selection is the real point of decision making. At many times, it is confirmed that selection of two or more alternatives is better than choosing only one alternative. Hence managers should plan in such a manner to select right combination.

**vii) Formulating Derivative Plans :** The departmental plans are known as Derivative plans. For instance, in order to generate desired profits for the organisation, production department should have production plans regarding number and quality of units to be produced.

**viii) Budgeting :** A budget is forecasted statement of revenue and expenditure, it is a numberised plan. It allocates the various resources to the required activities keeping in view of objectives. The organisation and each department working in it can have their own budget. Hence, budgeting is the last stage of planning which puts the plan into action.

The planning sequence discussed above, is almost similar to all the managers but may differ according to the complexity and time duration of plans like some steps may be prolonged and some stages may be shortened. Future, plans must be cost-effective. Thus, proper planning should be done keeping in view the circumstance, the need, the magnitude and level of commitment.

## 9.6 TECHNIQUES OF PLANNING :

Planning will be useful only when it is effectively implemented. The following techniques makes the planning effective.

**1. Consciousness for Planning :** Planning will be effective only when there is a proper climate for it. The superiors should try to set objectives, review various goals and redraft them as required for their effective implantation. The hurdles in the ways of planning should be removed. Every body should extend willing & co-operation for making the plans successful.

**2. Initiative at top level:** The initiative and support of top level management is essential for

making the plans effective. The involvement of lower level management is also essential because execution will be more at these levels.

**3. Proper communication :** Communication among different levels in the organisation is very essential. If plans are not properly understood by those who are to implement them then these may not achieve the desired results. Communication provides a channel for the exchange of information among various persons without a proper communications system planning is bound to fail.

**4. Participation in planning :** The method and extent of participation will depend upon the type of organisation participating of persons at different levels may help in proper implementation of plans.

**5. Emphasis on planning :** Both long terms and short term plans should get proper emphasis. For effective implementation of planning both long- term and short-term plans should be given on equal weightage.

**6. Timing :** Since the planning process is complex of any major and derivative plans and since plans are necessarily related to one another, it is important that they fit together, not only in terms of content and action, but also in terms of timings.

## 9.7 SIGNIFICANCE OF PLANNING :

**1. Minimises uncertainty :** Planning certainly minimises future uncertainties by basing its decisions on past experiences and present situations.

**2. Better utilisation of resources :** All the resources are first identified and then operations are planned. All resources are put to best possible uses.

**3. Economy in operation :** The operations selected being better among possible alternatives, there is an economy in operations.

**4. Better co-ordination:** Planning will lead to better co-ordination in the organisation which will ultimately lead to better results.

**5. Encourage innovation :** Planning helps innovative and creative thinking among managers because they will think of many new things while planning.

**6. Planning makes control possible :** Control cannot be exercised without planning. With the help of planning the actual output can be compared the desired one, difference is acquired and reasons are located to get necessary action towards unfavourable differences .

**7. Planning helps motivation :** The manager cannot only verify but can encourage workers to attain the targets. When tangible goals are insight it is easier to encourage the workers to reach those levels.

**8. Planning ensures against failures and setbacks:** Planning is based on estimates. It is an effort to visualise the future and attain goals through present action.

**9. Management by exception possible :** Planning fixes objectives of the organisation and all efforts should be made to achieve these objectives. Management should interfere in other aspects only when things are not going well. Thus by the introduction of management by exception, managers are given more time for planning. The objectives rather than wasting their time in directing day-to-day work.

## 9.8 LIMITATIONS OF PLANNING:

Despite of many advantages of planning there may be some obstacles and limitations in this process. The follow is are some of the limitations of planning.

**1. Lack of Reliable data:** Planning is based on various facts and figures supplied to the planners, which are difficult to procure absence of accurate data will upset the plan.

**2. Expensive:** Planning is an expensive process. The gathering of information and testing of various courses of action, setting up the planning machinery, require huge amount of money. Small companies can not afford to prepare plans.

**3. Time consuming exercise:** As planning involves a number of steps, a lot of time has to be devoted to plan before actual operations start.

**4. Lack of workers initiatives :** Under planning exercise worker has to act only mechanically. It robs him of his interest in the work .

**5. External factors may reduce utility :** Besides internal factors, there are external factors to which adversely affect planning. These factors may be economic, social, political, technological or legal.

**6. Psychological hurdle :** Human psychology also to an extent, places some hurdles in the success of planning. There is a certain degree of conservatism in people which implies resistance to change.

**7. Sudden emergencies :** In case certain emergencies arise then the need of the hour is quick action and not advance planning. There situations may not be anticipated.

## 9.9 SUMMARY :

Thus in the context of management, planning is the function of forecasting, framing of the objectives, policies, procedures, schedules, budgets etc,. It involves the consideration of all anticipated problems and a future course of action. Planning basically makes a choice from a number of alternative courses of action.

## 9.10 SELF- ASSESSMENT QUESTIONS :

1. Define planning, what are the Principles of Planning ?
2. Explain Planning Process?
3. What are the techniques of Planning?
4. Describe the significance and limitations of Planning

## 9.11 REFERENCE BOOKS :

1. *Principles and Practice of Management* - L.M. Prasad.
2. *Management* - Harold Koontz & Cyrill O'Dounnel
3. *Principles of Business Organisation and Management* -P.N..Reddy & S.S. Gulshan

**Dr. K.KANAKA DURGA**

## LESSON - 10

# OBJECTIVES OF A BUSINESS

### 10.0 OBJECTIVES:

The objectives of this lesson are:

- ❑ to know the meaning of Business
- ❑ to know the objectives of Business
- ❑ to know the obligations of Business

### STRUCTURE:

- 10.1 Introduction
- 10.2 Business
- 10.3 Characteristics of Business
- 10.4 Objectives
  - 10.4.1 Economic Objective
  - 10.4.2 Social Responsibility
- 10.5 Summary
- 10.6 Key words
- 10.7 Self - Assessment Questions
- 10.8 Reference Books.

### 10.1 INTRODUCTION:

Business is an adventure. Business men themselves proclaim in that their main object of business is to earn profits, but it has been found that a truly successful business cannot afford to keep profits as its sole objective. The purpose of business is to create a customer. It is the customer who determines what a business is. The customer is the king in the market. Business aims at meeting the needs of the community by ensuring a continuous supply of goods and services to its members who are customers. Business should aim welfare of its personnel shareholders, other investors.

### 10.2 BUSINESS:

Business activity has become an integral part of modern life. It is defined as, “the regular production or purchase and sale of goods undertaken with the object of earning profits and acquiring wealth through the satisfaction of human wants”

Since business activity involves the undertaking of risk, it is often rightly described as an adventure. This adventure involves the investment of resources in pursuit of some objectives calling for the supply of goods and services that the community needs. Business activity consists in systematically finding and exploiting opportunities. Those engaged in business have the important function of looking for business potential and converting problems into opportunities. If they succeed in the endeavour, they are rewarded with extraordinary return.

### 10.3 CHARACTERISTICS OF BUSINESS :

The definition of business can reveal the following characteristics.

- a. Sale, transfer or exchange of goods and services.
- b. Goods produced or acquired for business purposes may be consumer's goods or producers goods. Services are those intangible and invisible.

**Example :** Consumer goods – cloth, crockery, shoes etc.

Producers goods - machinery, tools etc.

Services- electricity, water, gas.

- c. The term business should be reserved for the exchange of goods and services undertaken regularly.-
- d. The profit motive is an important distinguishing feature of business.
- e. Business involves some element of risk and uncertainty in respect of return to the entrepreneur.

### 10.4 OBJECTIVES :

An objective may be a broad or general statement about the organisation or a specific and narrow one about a department or an employee's activities. It is a desired goal- a target or aim. Business objectives refer to the goals the business organisation pursue with the resources at their command. In general company wide objectives could be to:

- ❑ earn a fair return on investment for the share holders
- ❑ improve the market share
- ❑ provide quality service to customers
- ❑ adapt to the changing circumstances
- ❑ develop human resources
- ❑ ensure optimum utilisation of resources

These objectives can be translated into more specific objectives to understand them better and to measure the performance of the business.

Following chart shows the objectives of a business.

### 10.4.1 ECONOMIC OBJECTIVE :

Making and Maximisation of profits is an economic objective of any business.

**10.4.1.1. Profit Making :** Profit plays a vital role as a measure of efficiency and must be watched constantly. After all, profits provide not only the most accurate test of business efficiency, but also a sure check against failure. Over a course of time, profits are the measures of how well a company has meet the needs of labour, consumers, shareholders and the general public. Profits making is essential to business because of the following causes.

- a. For the survival of business
- b. For the growth of business
- c. to build up reserves for meeting risk inherent in business activity
- d. profit making company is acceptable company to the society.
- e. The profit is the legitimate reward for honest endeavours.
- f. Profit helps the entrepreneur for rendering service to the community .

### 10.4.2 Social Responsibility:

Social objectives implies social responsibility. Social responsibility means conducting operations in a free and fair manner, discharging its commitment towards different segments of its operational environment such share holders, consumers, employees, creditors, government, competitors and general public as explained below.

**10.4.2.1. Responsibility towards Shareholders:** The shareholders are the persons who provide the funds to the business and hence the management has some responsibility towards shareholders. The business should be managed efficiently so as to provide a fair return on the investments of the share holders. Further, the enterprise should supply accurate regular and comprehensive reports about its working.

**10.4.2.2. Responsibility towards consumers :** The business management has the positive responsibility towards the consumers of its products. It has to provide quality goods to consumers at the-

- right time
- right place
- right price

It must guard the consumers against the

- poor quality of goods
- Incorrect measures
- Poor after sales service
- Adulteration of goods

- Misleading advertisements
- Lack of Courtesy

**10.4.3. Responsibility towards employees:** The management has to provide a fair deal to its employees by planning for-

- social security
- profit sharing
- promotions
- Fair wages
- Equal opportunities
- Welfare
- Recognition
- Rewards
- Training.

The management should provide opportunities to the workers for the improvement of education, training and up grading of skills. The employer should encourage the workers to participate in the management. Further the management should try to get cooperation of the workers by creating good atmosphere and by providing better working conditions, living conditions to the workers. The management should not treat the workers as a commodity which can be bought and sold at their will. Efforts should be made to improve worker management relations and difference if any should be settled by negotiations without giving scope for strikes and lockouts.

**10.4.4 Responsibility towards Creditors :** The business must repay its loans as per the repayment schedule. Also it should inform the creditors about the development of the company from time to time.

**10.4.5. Responsibility towards Government:** The firm must pay its taxes and be fair in its endeavours. It should extend full support to the government in implements its policies and programmes relating to the solving of the national problems such as unemployment problem, food problem, wide disparity in income levels of the different sections.

**10.4.6. Responsibility towards Competitors :** The firm should always maintain the highest ethical standards and maintain cordial relations with each of its competitors.

**10.4.7 Responsibility towards Society :** The management should take responsibility for providing amenities in the locality where it is located. It should take measures to avoid bad effluent, fouling the air and conditions of slum and congestion.

**10.5 SUMMARY:**

To sum up business may be said to be any enterprise which makes distributes or provides any article or service which other members of the community need. Business transactions are essentially measured in terms of money. These measurements must show profits to the enterprise, if it is to remain in business. Yet a measuring device is not only profit, but also social responsibility.

**10.6 KEY WORDS:**

Legitimate : to give legal status or authorisation

Obligation: Commitment or responsibility

**10.7 SELF- ASSESSMENT QUESTIONS :**

1. Define business , what are its objectives?
2. Explain features of business
3. Describe social responsibility of business

**10.8 REFERENCE BOOKS:**

- |   |                                    |
|---|------------------------------------|
| 1. Industrial Organisation and Management           | -A.R AryaSri & V.V. Ramanam Murthy |
| 2. Management                                       | -Harold Koontz, Cyril O. Donnell   |
| 3. Fundamentals of Business Organisation Management | -Y.K.Bhushan                       |
| 4. Business Organisation and Management             | - M.C. Shukla                      |

**Dr. K.KANAKA DURGA**



## Lesson - 11

# ORGANISING

## 11.0 OBJECTIVES

After studying this lesson, you should be able to understand.

- organisation process and structure
- principles of organisation
- development of organisation structure

## Structure

- 11.1 Introduction
- 11.2 Definition of Organising
- 11.3 Concept of Organising
- 11.4 Structure of Organising
- 11.5 Process of Organising
- 11.6 Significance of Organising
- 11.7 Problems
- 11.8 Summary
- 11.9 Key Words
- 11.10 Self Assessment Questions
- 11.11 Reference Books

## 11.1 INTRODUCTION

Modern enterprises involve a large number of people. The problem before management is to obtain greatest possible orderly functioning with the help of people, who have diverse qualifications. This will help to build a coordinated and integrated approach to the objectives. The aims of organisation are optimum use of human skills and efforts, coordination of human effort, defining individual roles in the enterprise, to achieve orderly and smooth functioning. These aims are achieved through the principles of organisation.

## 11.2 DEFINITION OF ORGANISING

Almost any business managers will affirm that sound organisation is highly important to business success. Many will characterise organisation as the foundation upon which the whole structure of management is built. Organisation is understood as a dynamic process and a managerial activity which is necessary for bringing people together and trying them together in the pursuit of common objectives.

Organisation also refers to the structure of relationships among positions and jobs which is built up for the realisation of common objectives. In this, the static sense of the term, organising is the vehicle through which goals are sought to be attained. The organisation structure is viewed differently by various authors.

\* Some regard it “as a network of relationships, a blue-print of how the management will like the various functions and activities to be assigned and connected together”.

\* Some others look upon it “as a social system, consisting of the human relationships existing among people performing different activities”.

\* Some other authors say “an organisation is a system with inputs and processes through which these are converted into outputs.

\* Organisation can be defined “as the process of identifying and grouping the work to be performed, defining and delegating responsibility and authority and establishing relationships for the purpose of enabling people to work most effectively together in accomplishing objectives.

\* **‘Wheeler’** defined organisation as “Internal organisation is the structural framework of duties and responsibilities required of personal in performing various functions within the company. It is essentially a blue print for action resulting in a mechanism for carrying out functions to achieve the goals setup by company management”.

**‘Koontz and O ’Donnell’** opined - “organising involves the establishment of an intentional structure of roles through determination of the activities required to achieve the goals of an enterprise and each part of it, the grouping of these activities, the assignment of such groups of activities to a manager. The delegation of authority to carry them out, and provision for co-ordination of authority and informal relationships horizontally and vertically in the organisation structure”.

### 11.3 CONCEPT OF ORGANISATION

It is the purpose of an organisation to make common men do uncommon things” - this phrasing is **Lord Beveridge’s**. It is the test of an organisation that it make ordinary human beings perform better than they are capable of, that it bring out whatever strength there is in its members and use it to make all the other members perform more and better. It is the test of an organisation that it neutralize the weaknesses of its members. In this concept following factors help to the management.

**1) Division of labour:** The total work considered necessary for the realisation of common objectives is divided into activities and functions. Such division is essential because the work is too much for any single individual. In a business organisation the work is divided according to functions like -

\* Production

\* Marketing

\* Finance

\* Personnel etc.,

**2) Co-ordination:** The divided work for purposes of realising common goals, it becomes necessary to link up the various divisions, or activities so that all of them are unified and harmonised.

**3) Accomplishment of goals or objectives:** An organisation structure is built up around certain clear cut goals or objectives, because it is the ideal way of making a rational pursuit of objectives.

**4) Authority & Responsibility:** An organisation structure consists of various positions arranged in a hierarchy with a clear definition of the authority and responsibility associated with each of these.

## 11.4 ORGANISATION STRUCTURE

The following diagram shows both the horizontal and vertical dimensions of the organisation structure. It gives the levels of management and the line executives in descending order.

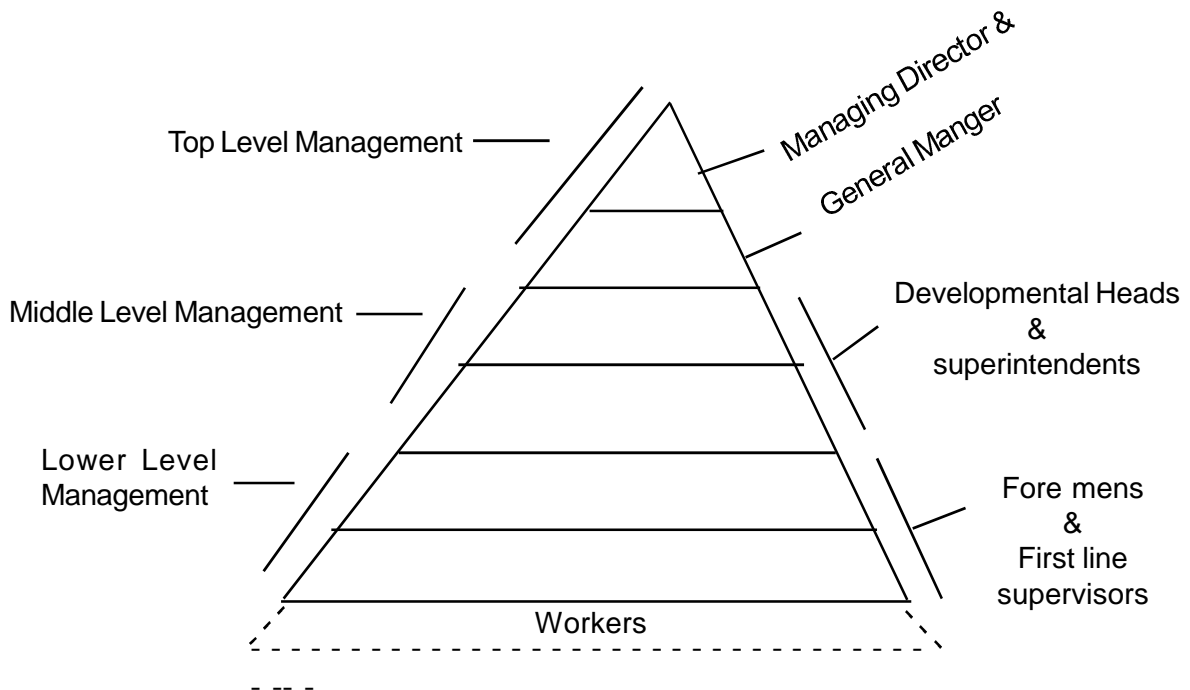

Fig. 11.1 Organisation structure

### 11.4.1 Principles of Organisation structure

Organisation theorists developed certain principles of organisation as guides to thinking in organising. These principles are intended for universal application to all enterprises and cooperative efforts in different fields. The most important of these principles can be listed under the following heads.

**(i) Division of Labour or Specialisation:** F.W. Taylor applied Division of Labour principle at the operation level and displayed how efficiency could be increased by breaking down jobs into single repetitive tasks performed on specialised tools.

**(ii) Consideration of Objectives:** Objectives are helpful in determining the activities and the structure itself. Once objectives are clearly defined, the organiser can conveniently proceed to group activities, delegate authority to individuals to whom activities have been assigned, and coordinate their efforts for better results.

**(iii) The Scalar Principle:** The vertical dimension of organisation structure consists of levels of authority arranged in a hierarchy from the chief executive at the top to the first line supervisor at the bottom. Existence of the levels is always the characteristic of organised and coordinated group efforts. The scalar principle holds that organisation consists of two or more levels of authority. In organisations, the levels represent gradations of distributed authority.

**(iv) The Principle of Departmentation:** Logical grasping of related jobs and functions is quite natural in developing the organisation structure. Departmentation requires analysing everything that has to be done and determining the grouping in which it can be placed without violating the principle of homogeneity. Departmentation is desirable because individuals vary considerably in the range of activities which their ability will permit them to perform effectively.

**(v) The Principle of Unity of Command:** A business organisation must have a single head in whom authority and responsibility are concentrated, but this has to be blended with the efforts of the organised people below. Unity of efforts, consistency of direction, high morale, and effectiveness of coordination depend upon one executive as the focus of ultimate responsibility.

**(vi) The Principle of Span of Control:** The idea of span of control is related to the horizontal dimension of an organisation structure. Span of control refers to the number of subordinates reporting directly to the executive, the more difficult it tends to be for him to supervise and coordinate them effectively.

**(vii) The Principle of Flexibility:** Organisation is created to accomplish certain goals. Both the environment and the individuals comprising the organisation are constantly in flux. To cope with these changes and yet reach its objectives, an organisation must be designed with sufficient amount of flexibility.

**(viii) The Principle of Balance:** This principle implies that each area and function of an enterprise should operate with equal effectiveness in making its allotted contribution to total purpose. The idea of balance applies to organisation structures as well as to functions and process.

**(ix) The Principle of Exception:** This principle implies that only problem involving unusual matters should be referred to upward and decided by higher level executives, and that routine problems should be passed on to lower levels and resolved there itself. Exception principle is also the principle underlying delegation of authority.

**(x) The Principle of Decentralisation:** One important implication of decentralisation is delegation of broad authority and decision-making power to the semi-autonomous units.

**(xi) The Principle of Simplicity:** Simplicity is an appealing objective because it implies economy of efforts. It is desirable to consider simplicity of structure in development of an organisation, aiming for as clear-cut structure as will permit doing the necessary work efficiently.

**(xii) Combination of Line and Staff Functions:** Organisation structures are usually of line, staff and function types. Line structure is part of every organisation. The staff and functional types are modifications of the line structure. Staff and Functional structures never exist apart from a combination with line structure.

The above principles are used as guides while designing the organisation structure.

## 11.5 PROCESS OF ORGANISATION

The process of an organisation may be described as the managerial function of organising. The managerial function of organising consists in making a rational division of work into groups of activities and trying together the positions representing grouping of activities so as to achieve well co-ordinated structure for the accomplishment of work. Following are the various steps involved in this process.

**1. Determination of objectives:** The first step of determination of objectives consist in deciding as to why the proposed organisation is to be setup and therefore, what will be the nature of the work to be accomplished through the organisation.

**2. Enumeration of activities:** The work of an industrial concern may be divided into the following major functions such as - production, finance, purchases, sales and personnel.

**3. Classification of activities:** In the third step activities are classified according to similarities common purposes functions and taking the human and material resources into account.

For instance - the various activities connected with production, may be grouped and classified as production department.

**4. Fitting individuals into Functions:** Each person in the group will be given a specific part of the job to do and will be made responsible for it. For instance - appointment of workers, foremen, supervisors etc.

**5. Assignment of Authority for action:** The manager will have to pass on studied either by a researcher from outside or by someone within the organisation working as a researcher.

## 11.6 SIGNIFICANCE

An organisation is not merely a chart or a lifeless structure. It comprises people and is the agency through which management performs the important functions of direction, co-ordination, motivation and control and implements the function of planning. Both as a process and as a structure, is important as without it no manager can get work done through people. Following are some of the advantages of a good organisation.

**1. Helps in optimum utilisation of Technological Innovations:** The technological improvements are taking place every time and management is required to make use of them to exist in competitive world. The organisation should be flexible to incorporate all new-requirements. There may also be a need to delegate new powers for making best utilisation of technological changes.

**2. Helps in administration:** A good organisation is an asset to the management. It helps in achieving organisation goals through the exercise of effective controls, organisation provides a channel for better management.

**3. Promotes growth and diversification:** Area and activities of a business grow if it has a well knit organisation. There will be a need for employing more persons whenever expansion and diversification takes place. A flexible organisational structure will enable the employment of more persons without disturbing the working.

**4. Easy coordination:** Every enterprise has a number of departments and sections. There are assigned different duties for achieving business objectives. A good organisation will bring an automatic co-ordination in the business and obtains team work among the personnel.

**5. Training and Development of Personnel:** A clearly defined authority provides a scope for the use of talent. There will be a sufficient scope to try new ideas in improving the working of the organisation. A well designed organisational system will provide a sufficient opportunity for the training of new trainees and development of existing staff.

**6. Encourages initiative:** In a good organisation persons are allowed to try new ideas for improving upon their work. Clearly defined work of every person allows them to grow in that sphere.

**7. Better Human Relations:** A clearly defined work, authority, responsibility, accountability will enable individuals to work in a free atmosphere. This will give job satisfaction to employees.

## 11.7 PROBLEMS OR OBSTACLES IN ORGANISING

**1. Failure to plan properly:** It is not unusual to find an enterprise continuing a traditional organisation structure long after its objectives, plans and external environment have changes. Certain managers have not grown with the company or do not fit to current needs. Personnel have a way of coming and going in an enterprise -through retirement, resignation, promotion or death - which makes organisation around them risky and hard to fill adequately. Such mistakes occur when an enterprise fails to plan properly.

**2. Failure to clarify relationships:** The failure to clarify organisational relationships, probably more than any other mistakes, accounts for friction, politics and inefficiencies. Since the authority and the responsibility for actions are critical in organisation, lack of clarity or knowledge of the part members are to play on an enterprise team. This implies lack of team work.

**3. Failure to delegate Authority:** A common complaint in organisation life is that managers are reluctant to push decision making down into the organisation.

Underdevelopment of managerial experience in the lower levels of organisation give evidence that failing to delegate authority to the proper extent is usually a decided mistake.

**4. Failure to Balance Delegation:** Another mistake made in organising is failure to maintain balanced delegation. Some managers in their zeal for decentralization, may take literally the organisational bromide to push decision making down in the organisation as far as it will go. Obviously it develops a system of independent organisation satellites. Managers must not forget that there is some authority they should not delegate.

**5. Confusion of lines of Authority and Information:** The problems and costs of levels of organisation can be reduced by opening wide the channels of information.

**6. Authority without Responsibility:** A significant cause of mis management is the granting of authority, without responsibility. All those to whom authority is delegated must be willing to be held responsible for their actions.

**7. Responsibility without Authority:** A common complaint of subordinates is that superiors hold them responsible for results without giving them the authority to accomplish them. It happens where organisation lines and duties have been not clearly set forth, and where an organised structure of roles is unclear or confused.

**8. Careless application of the staff device:** There are many valid reasons for using a staff assistant or staff specialist and even building entire advisory departments. However, there is danger that staff people will be used to undermine the authority of the managers they are intended merely to advise. There is an ever-present danger that top managers may surround themselves.

**9. Misuse of Functional Authority:** Perhaps even more perilous to good managing are the dangers in undefined and unrestricted delegation of functional authority. Functional authority over activities in other parts of the organisation.

**10. Multiple subordination:** The principal danger of too great proliferation of functional authority delegations is the breakdown of unity of command. Multiple subordination results also from faulty organisation structure and from instances of plural executives. It tends to cause confusion undermine the definiteness and effectiveness of authority, and threaten organisational stability.

**11. Misuse of service Departments:** People in line departments, regard a service department as relatively unnecessary, unimportant, and therefore something to be ignored when possible. The greatest misuse of service departments is summed up in the words "efficient inefficiency". When managers establish service departments, looking more to their cost savings than to the efficiency of the entire enterprise, a highly "efficient" service may do an inefficient job of serving.

**12. Overorganisation:** Over organisation usually results from failure to put into practice the concept that the activity - authority structure of the enterprise is merely a system for efficient performance of people.

## 11.9 SUMMARY

To conclude, organisation as a process refers to the act while organisation structure refers to the accomplished act. It is the process of creating a structure by grouping the activities of an enterprise and establishing authority, responsibility and relationship among the specialists for the attainment of defined objectives. It stimulates independent, creative thinking and initiative through well - defined areas of work.

### 11.10 KEY WORDS

Authority	:	Right or command thought
Responsibility	:	Accountability
Delegation	:	Empowering to act for another
Bromide	:	Tiresome person

### 11.11 SELF ASSESSMENT QUESTIONS

- 1) Define organisation and discuss the principles of organisation structure.
- 2) Describe the process of organisation
- 3) Explain significance and problems of organisation

### 11.12 REFERENCE BOOKS

- |  |   |                                 |
|--|---|---------------------------------|
| 1) Industrial Organisation & Management                  | - | R.K. Sharma & Shashi. K. Gupta  |
| 2) Management  | - | Harold Koontz & Cyril O' Donnel |
| 3) Perspectives of Management                            | - | D.V. Ramana Murthy (CDE)        |
| 4) Principles of Business Organisation<br>and Management | - | P.N. Reddy, S.S. Gulshan        |

**Dr. K.Kanaka Durga**  
**Reader in commerce,**  
**Hindu College,Guntur**



## **Lesson -12**

# **FORMAL AND INFORMAL ORGANISATIONS**

## **12.0 OBJECTIVES**

After studying this lesson you should be able to understand.

- Formal Organisation
- Informal Organisation

## **Structure**

- 12.1 Introduction**
- 12.2 Organisation**
- 12.3 Types of Organisation**
  - 12.3.1 Formal Organisation**
  - 12.3.2 Informal Organisation**
- 12.4 Differences between Formal and Informal Organisations**
- 12.5 Relationship between Formal and Informal Organisations**
- 12.6 Summary**
- 12.7 Key Words**
- 12.8 Self Assessment Questions**
- 12.9 Reference Books**

## **12.1 INTRODUCTION**

The formal organisation is a system of well defined jobs, each bearing a definite measure of authority, responsibility and accountability, the whole consciously designed to enable the people of the enterprise to work most effectively together in accomplishing their objectives. The informal organisation refers largely to what people do because they are human personalities - to their actions in terms of needs, emotions attitudes not in terms of procedures and regulations. In the Informal Organisation people work together because of their personal likes and dislikes.

## **12.2 ORGANISATION**

Organisation is the activity-authority structure of the enterprise. It is the particular system of arrangements, the pattern of network of relations, between the various positions in a business enterprise. The management determines the structure which they fill, will best serve company needs. Sound organisational structure is essential to any business because of the following reasons.

1. The administration of the enterprise is facilitated.
2. The areas of work for the employees are well-defined, leading to elimination of the overlapping and duplication of activities.
3. Communication between the management and employees becomes easier.

4. Growth, expansion and diversification become possible with the help of optimum use of technological improvements through specialisation.

The success of an organisation can be ensured better by the following principles.

1. The objective of the enterprise should be established for determining the activities and the structure itself.
2. Every part of the organisation should be geared to the achievement of the objectives.
3. The objectives should be attained at the minimum cost.
4. An executive should be asked to supervise a reasonable number of subordinates, say six. This is known as span of management or control.
5. The principle of division of work should be followed.
6. The establishment of responsibility - authority relationship will help in avoiding confusion and overlapping.
7. The line of authority from the chief executive at the top to the first line supervisor at the bottom must be clearly defined [Scalar Principle].
8. As the management at the higher level, has limited time, only exceptionally complex problems should be referred to them and the routine matters should be dealt with by executives at lower level [Exception Principle].
9. Each subordinate should have only one superior.
10. The authority delegated to subordinates should be adequate to assure their ability to accomplish results expected by them.

These main factors should be kept in mind in creating an organization structure. They are -

1. **Unity of Objective:** The organisation structure must contribute to the attainment of the goals of the enterprise.
2. **Principle of efficiency:** The principle of efficiency demands that the organisation structure should help the people to meet the objectives with minimum of unsought consequences.
3. **Individual and group satisfaction:** The organisation should provide individual and group satisfaction.

## 12.3 ORGANISATION - TYPES

Organisation structures are two types. They are -

1. Formal Organisation
2. Informal Organisation

**12.3.1. Formal Organisation:** The position, authority, responsibility and accountability of each level are clearly defined in the case of a formal organisation. It prescribes the relationship which exist amongst the people working in the organisation. This relationship is defined by rules, policies and other regulations of the organisation very consciously to enable the people of the enterprise to work most effectively together in accomplishing their objectives.

The formal organisation is a more or less arbitrary structure to which the individual must adjust.

It tells him to do certain things in a specified manner, to obey orders from designated individuals, and to work co-operatively with others.

Definite limits for the activities of people are set by the formal organisation. Defined responsibilities and authority provide relatively fixed fences within which people can develop their own work areas to the maximum without encroaching on the work of others.

#### **Features of Formal Organisation:**

1. Consciously brought into existence for predetermined objectives.
2. Authority and responsibility are defined.
3. The line of communication is also formalised.
4. The relationship of the superior and the subordinates is fixed.
5. It exists in a written form, and facilitates the determination of objectives and policies according to division of work.

**12.3.2 Informal Organisation:** Informal Organisation arises from the social interaction of people in the organisation. The people cut across formal channels and communicate amongst each other. It is due to friendship, mutual regard, intimacy and closed contact formed with relationship. Thus the informal organisation has no place in the formal organisation chart. It is formed to meet personal needs of the group and acts as an agency of social control. Informal organisation is not established by managers formally but arises spontaneously and naturally. For instance the members of a group may start recognising a person as their leader because of his age. Seniority, job-knowledge, information personality strength or skill etc., Thus informal organisation is earned not delegated. It is all-pervasive and is found in every enterprise at all levels of the managerial hierarchy.

It is very difficult to find a completely formal or a completely informal organisation. The formal managers should try to make use of informal managers for the achievement of goals of the enterprise.

#### **Features of Informal Organisations:**

Informal organizations are characterised by the following features.

1. It develops spontaneously and is not established by formal managers.
2. It is based as informal authority attached to the person, and not the position. Informal authority is earned and not delegated. This authority under informal organisation largely flows upward or horizontally.
3. Informal organisation represents human tendency to cut across formal channels and communicate informally with other parts of the enterprise.
4. People in the informal organisation are influenced by leaders without any formal authority.
5. It is all-pervasive and exists in every enterprise.
6. Informal organisation is not always destructive though at time it can make the job of managing more difficult. Because of its powerful influence on productivity and job satisfaction, formal management will do well to derive benefit from the study of informal organisation.

7. Informal organisation cannot altogether be abolished. Informal organisation is not created at the will of the formal managers; not the latter can do away with all the social conventions and group norms.

**Merits of Informal Organisation:**

1. Informal organisation blend with formal systems to make a workable system for getting work done. Many requirements which cannot be met with formal organisation can be met better by informal relations.
2. An informal organisation lightens the workload of the formal manager. If the employee know that their manager has the support of the existing informal organisation, they are more likely to respond to his ideas, to be motivated to work efficiently.
3. A significant benefit of informal organisation is that it gives satisfaction and stability to work group. It is the means by which workers achieve a sense of belongingness and security.
4. It is a useful channel of employee Communication. Management often depends on informal system to convey certain types of information.
5. Presence of informal organisation encourages a manager to plan and act more carefully than he would otherwise.

**Drawbacks:**

Informal organisations create a major danger or difficulty which require careful attention on the part of management.

- 1. Resistance to Change:** With the persistence of certain culture, these develops a tendency to perpetuate the 'status quo' and oppose change.
- 2. Role Conflict:** What is good for the employee is not always good for his employer. Hence a role conflict occurs.
- 3. Rumour:** Communication leads to rumour. Rumour is a dangerous disease that sweeps through an organization as fast as wild fire, and usually with as much damage.
- 4. Conformity:** Social control exerts strong pressures for conformity under formal organisation. But conformity is caused as much by informal organisation.

**Control of Informal Organisation:**

Organisation should be viewed as a positive force. Informal organisation lightens the burden of formal managers. It helps to fill in the gaps in formal orders and managers abilities, provides for satisfaction and stability to the workmen. However, benefits of informal organisation will accrue only when it is properly controlled and its potential power properly channelised. the significant aspects of manager's duty in this connection are:

1. He should recognise and reconcile himself to the existence of informal organisation.
2. He should influence the informal organization, so that its role is positive and the negative aspect is minimised.
3. He should integrate informal organisation, with formal organisation, in such a way that the former also contributes to the accomplishment of enterprise objectives.

4. He should make informal organisation, secondary to formal organisation.

## 12.4 DIFFERENCES BETWEEN FORMAL AND INFORMAL ORGANISATIONS

The formal and informal groups differ considerably and the major differences can be analysed as follows.

Formal Organisation	Informal Organisation
<p><b>1. Origin:</b> A formal group is created by the action of management in order to overcome the shortcomings of organisation structure.</p> <p><b>2. Authority Structure:</b> In formal groups members derive authority through the formal source, that is through delegation and redelegation.</p> <p><b>3. Nature of Groups:</b> Formal groups are stable and continue for longer time. Their membership is decided by the organisation and there is provision of substitution of members.</p> <p><b>4. Behaviour of Members:</b> Behaviour of members in a formal group is governed by formally prescribed rules and regulations.</p> <p><b>5. Communication pattern:</b> Communication in a formal group takes place on the lines of formal prescription</p> <p><b>6. Size of group:</b> Size of group is based on the criterion of efficiency. It can be quite large in size.</p> <p><b>7. Abolition:</b> Many formal groups are created for specific purpose and when the purpose is served the groups are abolished by the organisational action.</p>	<p>1. Informal groups are created because the members of the organisation are not fully satisfied by the pattern of relationship prescribed by the organisation.</p> <p>2. In an informal group, every member is equal and they derive authority from interpersonal relationship.</p> <p>3. Informal groups are quite unstable. Since they are created by the members based on their value systems, likings, dislikings, they may disappear because of the change of members or their working is changed.</p> <p>4. In an informal group, the behaviour of members is governed by group norms, beliefs and values.</p> <p>5. In the informal group, communication can go through any direction as there is no prescribed channel.</p> <p>6. The size of informal group tends to be small so that there is proper interaction among members to maintain group cohesiveness.</p> <p>7. Informal groups are created by people in the organisation on their own. Therefore, they can not be abolished by management action though such groups may affect the organisational functions adversely.</p>

## 12.5 RELATIONSHIP BETWEEN FORMAL AND INFORMAL ORGANISATIONS

Formal and Informal organisations are the parts of the total organisation and therefore, it can be said that they are two sides of the same coin. The following points shows the relationship between these two groups.

1. It is difficult to find a completely formal or a completely informal organisation.
2. The managerial functions are performed in both-formal and informal organisations.
3. In fact many times the informal organisation can prove to be important mechanism of proper and effective functioning of formal organisation.
4. The formal organisation may facilitate informal association in several ways such as people work close to each other.

## 12.6 SUMMARY

Thus, in the case of formal organisation the position, authority, responsibility and accountability of each level are clearly defined. It prescribes the relationship which exist amongst the people working in the organization. On the other hand, informal organization arises from the social interaction of people in the organization. The two types of organizations differ in some aspects and have relationship in some other aspects. Infact informal organization is a supplement to the formal organization.

## 12.7 KEY WORDS

Organisation : Designing the roles

Span of Management : The number of Subordinates required under the control of a Manager.

## 12.8 SELF ASSESSMENT QUESTIONS

1. Define formal organisation and explain its functions.
2. Describe Informal organisation.
3. Differentiate formal groups from informal groups.

## 12.9 REFERENCE BOOKS

1. Principles and Practice of Management - L.M. Prasad
2. Management & Organisation - Louis AAllen
3. Principles of Management - P.C Tripathi & P.N. Reddy
4. Perspectives of Management - D.V. Ramana Murthy (C.D.E.)

**Dr. K.Kanaka Durga**  
**Reader in commerce,**  
**Hindu College,Guntur**

## Lesson - 13

# ORGANISATIONAL DESIGN AND DEPARTMENTATION

## 13.0 OBJECTIVES

The present lesson focussed on organisational design, factors of organisational design, organisational process and structure. Further, focussed on departmentation types of departmentation, advantages and disadvantages of departmentation.

### Structure

- 13.1 Introduction
- 13.2 Organisational Design
- 13.3 Factors of Organisational Design
- 13.4 Organisational Processes
- 13.5 Organisational Structure
- 13.6 Departmentation - Definitions - Scope and Importance
- 13.7 Types of Departmentation - Advantages and Disadvantages
- 13.8 Summary
- 13.9 Technical Terms
- 13.10 Self Assessment Questions
- 13.11 Reference Books

## 13.1 INTRODUCTION

The classical design has been in existence since the earliest management days and has been supported by such stalwarts as **Henri Fayol**, **Fredrick Taylor** and **Lyndall Urwick**. The classical design is highly structured in a hierarchial system of superior and subordinates in the form of a pyramid. It is a system of complex mechanisms, rules, regulations, and procedures that are highly disciplinary in nature and the responsibilities of personnel are explained by their positions in the hierarchy. Moreover, the departmentation is the process of grouping various activities into separate units of departments. A department is a distinct section of the business establishment concerned with a particular group of business activities of like nature.

## 13.2 ORGANISATIONAL DESIGN

The classical organisation design has been in existence since the earliest management days and has been supported by such stalwarts at **Henri Fayol**, **Fredrick Taylor**, **Lyndall Urwick**. The classical design is highly structured in a hierarchial system of superior and subordinates in the form of a pyramid. It is a system of complex mechanisms, rules, regulations, and procedures that are highly disciplinary in nature and the responsibilities of personnel are explained by their positions in the hierarchy.

**Approaches:** This approach has been critically attacked by the exponents of behavioural sciences as being overly mechanical and ignores the human aspects. The proponents of this approach like **Elton Mayo, Mary Parker Follet, Chester Barnard, Douglas Mc Gregor** etc. suggest that there should be less emphasis on hierarchy and more participation of lower ranks in the decision making process. The structure should be less formal and more democratic.

In recent years a new type of organisation is coming into focus, which is much more informal in nature with a minimum of formal division of duties and is known as the “organic structure”. It deemphasizes authority and concentrates on problem solving.

### 13.3 FACTORS OF ORGANISATIONAL DESIGN

Some of the factors to be considered in designing an operational and effective organisation are:

**(a) Environment:** The external environment is an important strategic factor affecting the organisational design in relation to relation stability or unpredictable rapid changes. This would consider the impact of customers, suppliers, competitors, legal and political changes, and economic conditions. A more uncertain environment will have less predictable elements requiring the use of more specialised experts who are trained to deal with the problems created by an ever changing situation. A stable environment can go for a more mechanistic structure.

**(b) Technology:** Technology is a combination of tools, techniques and know how and has a major influence on organisational structure. The design of the organisational structure would depend upon whether the technology is simple and routine requiring few repetitive tasks, where as mechanistic structure is beneficial or complex, intensive technology where there is a high interdependence among members of the work-force, an organic structure will be operationally more effective.

### 13.4 ORGANISATIONAL PROCESSES

Joan Woodward studied the relationships between technology and organisational structure in the early 1960's among some english manufacturing firms. She observed and concluded that technology is a major influence on organisational structure. She observed three types of production processes and their corresponding structures and concluded that the right combination of structure and technology was highly critical. These three processes are:

**1. Small batch production:** This involves specilised custom made products which requires special equipment and individual attention. An example would be making large stained glass windows.

**2. Mass Production:** This is an assembly-line type of production in which a standardised item is produced in large numbers with reasonably sophisticated equipment and the work units depend upon each other in a sequential manner. This is also known as long link technology. An example would be the manufacture of air conditioners or cars.

**3. Continuous Process Technology:** This system is highly sophisticated and automated and requires the use of complex technology, as in the case of automated chemical plants. In such situations the use of robotics and cybernetics is very common with continuous feeding of raw materials and self-controlling and self-correcting provision. In small batch as well as, continuous process, where technology is complex in terms of problem - solving requirements with a high interdependance among members of the work-force, the organic structure brings out the optimal results.



## 13.5 ORGANISATIONAL STRUCTURE

Organisation structure is the established pattern of relationships among components or parts of the organisation. It prescribes the relationships among various positions and activities in business.

While developing an organisation structure, the two variables i.e. basic structure and operating mechanism are to be taken into consideration. The basic structure involves issues such as how the work of the organisation is to be divided and assigned among positions, groups, departments, divisions etc. and how to bring the required coordination for achieving organisational goals. The operating mechanism includes factors like information system, control procedures and application of organisational principles and practices.

An organisation structure serves various functions of the business. It is designed to serve specific motives. There should also be efforts to match organisation structure with changing needs. A good structure not only facilitates communication but also brings efficiency in different segments.

## 13.6 DEPARTMENTATION DEFINITIONS, SCOPE, AND IMPORTANCE

Departmentation involves grouping of people or activities with similar characteristics into a single department or unit. This facilitates communication, coordination and control, thus contributing to organisational success. It creates semi-autonomous units with independent responsibilities, providing satisfaction to the managers which in turn improves efficiency and effectiveness.

### Definitions:

According to **Knootz** and **O'Donnell** a department is defined as designating - "a distinct area, division, or branch of an enterprise over which a manager has authority for the performance of specified activities".

### Scope and Importance:

Most enterprises are involved in producing a product or a service for the benefit of others. The latter aspect requires marketing or distribution so that the persons for whom the product or service is intended to accept it. These activities require money or sufficient capital or finance. Thus for every organisation or enterprise there are three fundamental activities or functions to be performed, namely 1. Production, 2. Marketing and 3. Finance. Thus functional departmentation consists of grouping of common activities to form an organisational unit. In short, units are formed around common functions. The term functional departmentation is often used at the higher organisational levels. In addition to the functional departmentation on the basis of production, marketing and finance, it is possible to attempt departmentation in different ways such as by product, by territory, by customer, by process and by task-force. Top management is at liberty to use any means of departmentation while forming an organisation structure. Usually for the top and bottom organisation levels, functional departmentation is followed and for the intervening organisation levels other means of departmentation are used. The selection of the media of departmentation will be determined on the basis of the extent to which it is likely to achieve the objective.

## 13.8 TYPES OF DEPARTMENTATION, ADVANTAGES AND DISADVANTAGES

Departmentation can be in the following seven ways, namely -

1. by function
2. by product
3. by territory, region or geographical area
4. by customer
5. by process
6. by task force and
7. by appropriate combination of these types

### (i) Departmentation by function

The simplest and the commonest type of departmentation is the functional type of structure which consists of grouping all similar activities of the business into major departments or divisions under an executive reporting to the chief executive such as the managing director. The activities are here grouped on the basis of functions to be performed like marketing product planning, marketing research, advertising and sales. This is the simplest and most common type of organisation structure and is depicted in the following chart.

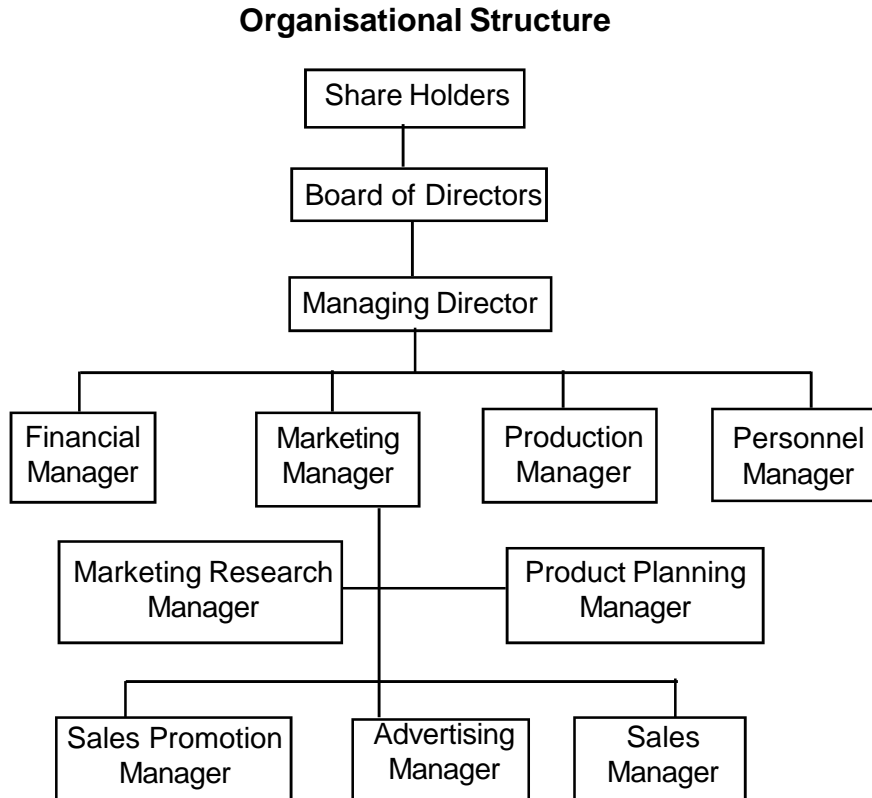

It will be noticed that below the Managing Director are four managers in charge of separate functions, namely, finance, marketing, production and personnel. In the marketing set-up, described in greater detail in this chart, under the marketing manager, separate managers are delegated functions such as marketing research, product planning, sales, advertising and sales promotion. In this way, similar activities are grouped together into major departments and placed under an executive who reports to the higher executive. The chart shows a more detailed functional basis. This type of departmentation or structure is quite suitable for small and medium sized businesses where the chief executive can easily co-ordinate his functional specialists.

The advantages of this type of structure are

1. benefits of occupational specialisation;
2. easier inter-departmental co-ordination; and
3. logical and simple, easy-to-understand structure;

The disadvantages of the Functional Departmentation

1. excessive centralisation;
2. unsuitability where geographical centralisation is required.
3. unsuitability where emphasis on product lines is called for; and
4. Lower potency for developing managers for promotion.

## **2. Department by product**

The arrangement emphasizes the use of specialised knowledge and encourages a reasonable degree of specialisation. For example, the departmentation of department store is on the basis of types of products. A type of organised departmentation which has gained favour in recent years with large organisations with distinct types of products is the product type of organisation structure. In this type, the product lines are segregated and special product executives are placed in charge of each line. In this type of structure, the marketing director may have a number of marketing managers under him, each looking after a different group of products. Each marketing manager will then have under him his own organisation looking after the sales etc., of that particular product or line of products. The marketing director has under him three sales managers looking after different groups of products, namely, batteries, points, radios and industrial products.

Thus in case of companies which are smaller than giant corporations with separate divisions, the popular form of structure is to assign to product or brand managers (some times even called sales managers) the responsibility for marketing decisions of particular products or groups of products. The product manager here becomes like a little marketing manager. Advertising, sales promotion, marketing research, etc., can be centralised staff activities.

The following are some of the advantages of the product type of structure or departmentation

1. Where it is extended right down to the salesman's level, it results in better customer service as the salesman has deeper product knowledge.
2. It simplifies determination of the profitability of each product line.

3. A new division can be added without interrupting the existing operation by merely extending the line and having another marketing manager and staff for that new product line or group of products.
4. Top management secures more detailed and intimate information regarding the markets in relation to specific products.
5. It is extremely suitable where product lines are complex and diverse and require specialised knowledge for selling and marketing as well as salesmen with specialised knowledge.

### Disadvantages

1. It may cause customer annoyance and confusion as a number of salesman from the same company may pester him for different products.
2. It involves extra costs of maintaining separate sales forces for each product group.
3. There is a duplication of costs such as travelling expenses.

### 3. Territorial Geographical Departmentation

When several activities of an enterprise are geographically dispersed in different locations, territorial or geographical departmentation may be adopted. All activities relating to a particular area or zone may be grouped together under one zonal manager or head. there may be further sub-division of activities under one zonal manager as illustrated here.

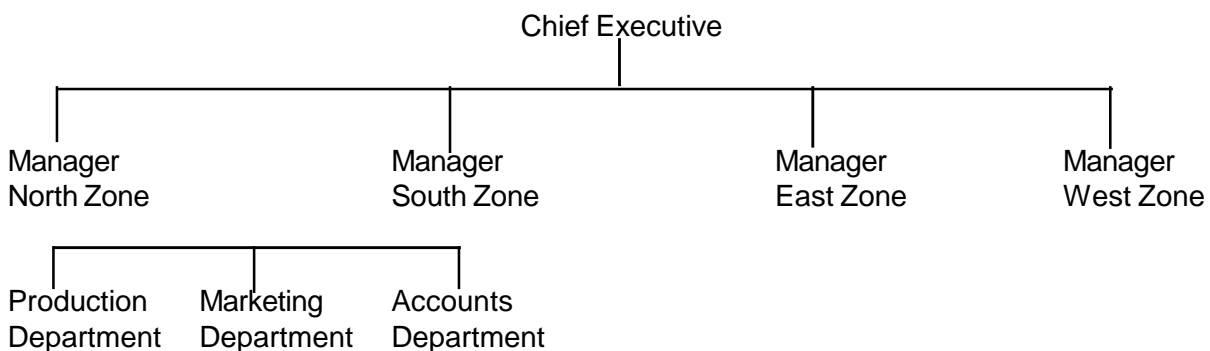

### Advantages:

The territorial departmentation offers the following advantages.

1. It enables an enterprise to cater to the needs of local people in a satisfactory manner.
2. It enables a concern to make use of locational advantages.
3. It facilitates effective control.
4. It facilitates effective co-ordination of activities within an area.
5. It assists in the development of all-round managerial talent.

**Disadvantages**

1. It is an expensive method of creating departments and over head costs are also increased.
2. It leads to duplication of activities which creates confusion and involves costs.
3. Co-ordination among various territorial divisions may become difficult.

**4. By Customer**

A business house may be divided into a number of departments on the basis of customers it serves viz., large and small customers, industrial and ultimate buyers; government and other customers etc. The peculiar advantage of customerwise departmentation is that it ensures full attention to different types of customers and their different needs, tastes and requirements can be met effectively. However it may not be possible to group all activities of an enterprise on the basis of cusotmers. In fact, sales activities may be classified or grouped on such basis. But there may be problems of co-ordination with other departments. There may not be enough work, at times, in case of certain types of customers. This may lead to idle capacity.

**5. Equipmentwise departmentation (by task force)**

An enterprise where production is carried through different processes may adopt process-wise departmentation to enable continuous flow of production. Similarly, where work is carried on by machines which are common, departments may be created on the basis of equipments, such as milling departments, grinding departments, lathe department etc. The main advantage of this method is that it avoids duplication of equipment invarious activities. Moreover, specialised people can be engaged to work on specialised equipments and departments.

**6. By Task Force:**

Under this system the responsibility for the completion of work rests upon an entire task - team and normally one individual acts as the leader of the task force. Every member of the task-force identifies the objectives and fully comprehends them. This type of departmentation is also termed "project organisation" and is a refinement of advanced planning and controlling techniques such as PERT. This system helps to build an organisation unit aimed at completing a series of events utilising the best available talent. After the project is completed, the organisation is disbanded with the personnel and physical resources becoming available for personnel, since each member is objective minded and thanks always of achieving the good.

**Advantages:**

1. The possibility of developing manager's who can use different types of resources and
2. the specialised complete team setup for performing the task results in greater concentration and more production results.

**Disadvantages:**

1. The fostering of a feeling of frustration caused by being a separate unit and not a part of the whole team with chances of promotion to the highest positions being less.

## I. Departmentation by a combination of types

Huge corporations often combine the advantages of both the functional and the product divisional types of organisations where such a combination is maintained, the central office product manager exercise his authority on the decentralised staff personnel indirectly through the division executive. A clear distinction has to be made between the line and functional authority. The divisional manager will have line authority overall executives who report to him and over sales and thus has the right and responsibility to develop sales policy and methods. The functional specialists report to the chief executive having no line authority but merely functional authority.

## 13.8 SUMMARY

In this lesson organisational design, factors of organisational design, organisational processes, and organisational structure, are explained in detail. The classical design has been in existence since the earliest management days. Moreover, most enterprises are involved in producing a product or a service for the benefit of others. Therefore, departmentation involves grouping of people or activities with similar characteristics into a single department or unit. Thus, the selection of the media of departmentation will be determined on the basis of the extent to which it is likely to achieve the objective. As such departmentation can be classified into seven types. viz. (1) by function, 2. by product, 3. by territory, 4. by customer, 5. by process, 6. by task force and 7. by appropriate combination of these types.

## 13.9 TECHNICAL TERMS

Design	-	Prepare a design for plan, intend
Processes	-	a series of action to achieve an event
Structure	-	the way a thing is constructed
Department	-	a section of an organisation with a special function

## 13.10 SELF-ASSESSMENT QUESTIONS

1. What do we mean by “organisational design? Explain in detail?
2. what factors should be considered in designing an operationally effective organisation?
3. What is departmentation? Describe the process involved in departmentation?
4. Define departmentation? Explain the various kinds of departmentation and its advantages and disadvantages.

## 13.11 REFERENCE BOOKS

1. Rustom S. Dauar, *The Management Process, The Principles of Management* - Progressive Corporation Private Limited - Mumbai.
2. J.S. Chandan, *Management Theory and Practice*, Vikas Publishing House Pvt. Ltd., New Delhi - 2004.
3. R.K. Sarma, *Industrial Organisation and Management*, Kalyani Publishers - New Delhi, 2003

**Dr. K.Kanaka Durga**  
**Reader in commerce,**  
**Hindu College,Guntur**

## Lesson - 14

# SPAN OF CONTROL - LARGE VS SMALL

## 14.0 OBJECTIVES

On completion of this lesson you should be able to understand

- \* meaning, scope and significance of Span of Control,
- \* theories of Span of Control,
- \* limited Span of Control and,
- \* various factors determining the Span.

## Structure

- 14.1 Introduction
- 14.2 Meaning, Scope, and Significance of Span of Control
- 14.3 Theories of Span of Control
- 14.4 Limited Span of Control
- 14.5 Factors determining the Span
- 14.6 Summary
- 14.7 Technical Terms
- 14.8 Self-Assessment Questions
- 14.9 Reference Books

## 14.1 INTRODUCTION

A good organisation structure should meet various needs and requirements of the enterprise. The following are the features of a good organisation structure.

1. There should be a clear *line of authority* from top to the bottom.
2. *Delegation of authority* must be commensurate with the responsibility assigned.
3. As far as possible *minimum levels of management* may be created.
4. *Span of control*: This refers to the number of people a manager can directly supervise. A person should supervise only that number of subordinates to whom he can directly keep under contract.

## 14.2 MEANING, SCOPE AND SIGNIFICANCE OF SPAN OF CONTROL

The span of control has been defined as the number of subordinates under one manager. It is also known as "span of management". In a wider span of control, a manager has many subordinates who report to him. In a narrow span of control, a manager has fewer subordinates. Obviously, the number of subordinates that can be effectively managed for supervision and delegation of authority would depend upon a number of factors.

## 14.3 THEORIES OF SPAN OF CONTROL

### (A) Hamilton's Theory

Perhaps the first person to bring the principles of span of control to public attention was a soldier - the late **General Sir Ian Hamilton**. The following statement of his, although it reflects his military association, has great application to any other type organisation -

The average human brain finds its effective scope in handling from three to six other brains. If a man divides the whole of his into two branches and delegates his possibility, freely and properly, to two experienced heads of branches he will not have enough to do. The occasions when they would refer to him would be too few to keep him fully occupied. If he delegates to three heads he will be kept fairly busy whilst six heads of branches will give most bosses a ten hours day. Those data are the results of centuries of the experience of soldiers, which are greater, where organisation is in question, than those of politicians, businessmen or any other class of men.

Of all the ways of waste there is none so vicious as that of your clever politician trying to run a business concern without having any notion of self-organisation. One of them who took over munitions for a time had so little idea of organising his own every that he nearly died of overwork through holding up the work of others; i.e., by delegating responsibility coupled with direct access to himself to seven sub-chiefs! Now it will be understood why a Battalion has four companies (and not seventeen): why a Brigade has three or four battalions (and not seventeen)

The nearer we approach the supreme head of the whole organisation, the more we ought to work towards groups of six.

### (B) Graicunar Formula

The French management consultant **V.A. Graicunar**, after analysing subordinates - superior relationships, developed a mathematical formula. His theory identifies developed a mathematical formula. His theory identifies three types of subordinates - superior relationships, namely:

1. direct single relationships
2. direct group relationships, and
3. cross relationships

He felt that direct single relationships were easily understood and recognised but one should not forget the relationships with different groups of subordinates and the cross relationships between all the subordinates. These relationships vary considerably with the size of the subordinates groups. While the supervisor's own direct relationships with individuals increase in proportion to the addition of subordinates, the group and cross relationships increase much more than proportionately.

## 14.4 LIMITED SPAN OF CONTROL

There are both benefits and criticisms of the advice to have a limited span of control. The advantages of a narrow span are -

1. tighter control and closer supervision



2. ease of managing fewer and more specialised people and activities; and
3. availability of time to think and plan for the future.

As against these criticisms levied against the span include

1. the additional costs of having more managers with their respective staff.
2. added complexity introduced in connection with communications by having more levels; and
3. Prevention of democratic participation within the organisation.

Critics of the narrow span advocate a more flat set up or organisation structure which reduce the levels and administrative distance, thus generating initiative and group cohesiveness.

It is interesting to note that a study conducted by the American Management Association indicated that in case of over 50 per cent of the sample, the chief executives span was 9 or more subordinates. One third of them had 11 or more subordinates.

What can be agreed is that as one travels higher up the hierarchical structure of management, there will be a decrease in the span of management of the number of persons who can be effectively supervised. The limitation inherent in the span of control makes delegation of authority necessary and reveals the importance of adequate organisation to attain the objectives.

It is possible to reduce the burden of the manager and expand his span of control by means of adequate delegation coupled with clear planning. The span of control can be increased by the ability to communicate plans and instructions concisely and clearly.

## 14.5 FACTORS DETERMINING THE SPAN

**A. Similarity of functions:** If the subordinates are involved in the same or similar activities, then it is possible for the manager to supervise more subordinates, since the problems that may arise would be similar in nature, these would be easier to handle. Conversely, if these subordinates are doing diversified operations, the situation would be more complex and hence the span of control should be narrow.

**B. Complexity of functions:** If the operations that the employees are performing are sophisticated and complex and require constant supervision, then it would be more difficult for the manager to manage too many employees.

**C. Geographical closeness of employees:** The closer the subordinates are in a physical location, the easier it will be for the supervisor to manage more employees.

**D. Direction and Co-ordination:** The span of control would also be determined by the degree of coordination required, both within the unit and with other units of other divisions.

If the unit needs continuous directions and extra time of the manager in coordinating the activities then fewer subordinates will be better supervised.

**E. Capacity of Subordinates:** Subordinates who are trained, developed and experienced, need little supervision in discharging their duties. In such situations, more subordinates can be effectively supervised. These subordinates can further be assisted by providing them with "standing plans" which are applicable in repetitive actions and recurring problems, requiring less direct supervisory assistance.

**F. The working staff of the manager:** If the manager has supporting staff that is equally skilled in handling situations then it would be possible to manage a wider span of control because the responsibilities of supervision would be shared.

**G. Planning:** The effectiveness of supervision would also depend upon how much time manager spend upon planning activities. If the managers spend too much time in systems planning then they will not have time to supervise the activities of too many subordinates.

## 14.6 SUMMARY

The term 'span' literally means the space between two supports of a structure e.g., the space between two pillars of a bridge. The space between the two pillars should neither be too large nor too small. If it is too large, the bridge may collapse; and if it too small, it will enhance its costs. The ideal number may be different under different situations depending upon the time, knowledge, energy and abilities of the supervisor.

## 14.7 TECHNICAL TERMS

Span : Something's extent them end to end, the distance.

Delegation : to grant or confer authority

## 14.8 SELF - ASSESSMENT QUESTIONS

1. Explain the meaning, scope and significance of span of cotnrol.
2. How is proper span of management determined.
3. Which factors affect span of control.
4. What do you understand by span of supervision? Explain various types of span of supervision.

## 14.9 REFERENCE BOOKS

1. J.S. Chandan, *Management : Theory and Practice*, Vikas Publishing House Pvt. Ltd., New Delhi - 2004.
2. Rustom S. Dallar, *The Management Process. The Principles of Management*, Progressive Corporation Pvt. Ltd., Bombay - 1978.
3. S.A. Sherlekar, *Modern Business Organisation and Management - Systems Approach*, Himalaya Publishing House, Bombay - 1982.

**- Dr. D. NAGESEARA RAO**

## **Lesson - 15**

# **DELEGATION AND DECENTRALISATION - DETERMINING DEGREE OF DELEGATION**

## **15.0 OBJECTIVES**

After completion of this lesson, you should be able to understand:

- \* Delegation and Decentralisation
- \* the nature of Delegation, Process of Delegation
- \* benefits and Problems of Delegation
- \* Ten commandments of Effective Delegation
- \* Centralisation - Decentralisation
- \* benefits and Disadvantages of Decentralisation

## **Structure**

- 15.1 Introduction**
- 15.2 The Nature of Delegation**
- 15.3 Process of Delegation**
- 15.4 Delegation without Abdication**
- 15.5 Benefits of Delegation**
- 15.6 The Problems of delegation**
- 15.7 Obstacles to Effective Delegation**
- 15.8 Ten commandments of Effective Delegation**
- 15.9 Nature of Decentralisation**
- 15.10 Centralisation Vs Decentralisation**
- 15.11 Benefits of Decentralisation**
- 15.12 Problems and Disadvantages of Decentralisation**
- 15.13 Factors determining the extent of Decentralisation**
- 15.14 Summary**
- 15.15 Self-Assessment Questions**
- 15.16 Reference Books**

## **15.1 INTRODUCTION**

Authority is the degree of discretion conferred on people to make it possible for them to use their judgement. The main purpose of delegation is to make organisation possible. Further, decentralisation of authority is a position where the ultimate authority to command or control as well as the ultimate responsibility for results is placed as far down in the organisation as in consonance with the efficient management of the enterprise. Thus delegation and decentralisation are related concepts.

## **15.2 NATURE OF DELEGATION**

In Management, the term delegation is generally used to mean the granting of right and approval to others to function within prescribed limits. In short, delegation enables the subordinate to receive

from his superior authority to accomplish tasks assigned to him, and the superior and at the same time retains his original authority. The delegation of authority takes place when organisational power is given to a subordinate by a superior. A manager cannot delegate authority which he himself does not possess. The entire process of delegation of authority starts with an assigning of the tasks.

Thus, the delegation process consists of three facts namely -

- (1) an assignment of the task or duty creating an obligation or responsibility.
- (2) a granting of the necessary authority, approval, right or power, and
- (3) the creation of accountability for failure to perform the task so assigned.

The first step of assigning duties and responsibilities forces the executives to consider how best the work can be sub-divided into responsibilities to be assigned and selection of those who are best fitted to discharge such responsibilities.

Delegation of authority can be specific or general, written or unwritten and it must be accompanied by certain kinds of assignment of duties. It is always better to delegate the authority specifically in writing to avoid conflicts and overlapping.

## **15.4 DELEGATION WITHOUT ABDICATION (fail to fulfil)**

The grantor can always recover the authority which he had delegated. In short, the original possessor does not permanently relieve himself of the power of recovery of authority by merely delegating it. Therefore a manager may recover all the formerly delegated authority and redelegate it partly or completely to another person as the situation in the organisation may require.

## **15.5 BENEFITS OF DELEGATION**

**1. Relieving top Executives:** Top executives cannot perform and supervise each and every work. Moreover, they are required to undertake important tasks of planning and controlling. Delegation helps executives in delegating their work to subordinate officers.

**2. Improved functioning:** In the absence of delegation some persons may be burdened with more tasks while others may not have sufficient work to do. Delegation helps in rationalising the functioning of an organisation. Work is divided among various persons in such a way that it is done in an efficient way. Nobody is unduly burdened and no work is left unattended.

**3. Use of specialists:** Delegation enables the use of specialists for taking up different functions. A production manager will be assigned the task of production, a sales manager will look after sales department, a lawyer will look after legal matters and so on. The use of specialists for different functions will improve the quality of work.

**4. Helps in Employee Development:** Delegation of authority is a very important step in the development of subordinates. The benefits of participation in various executive training programmes, seminars and workshops may not be substantial if delegation of authority is neglected.

**5. Provides Motivation:** Adequate delegation, resulting in development of subordinates, encourages the subordinates to look forward to promotions in the future. This motivates them to better and more effective efforts on their respective jobs.

## 15.6 THE PROBLEMS OF DELEGATION

Despite the benefits of delegation, in practice there are many problems. There are :

- 1. Over confidence of Superior:** The feeling in a superior that only he can do certain work effectively than others is the main difficulty in delegation.
- 2. Lack of confidence in subordinates:** The superior may be of the view that subordinates are not competent to carry out certain things of their own. He may lack of confidence in his subordinates. Under these circumstances superior will hesitate to delegate authority.
- 3. Lack of ability in superior:** A superior may lack the ability to delegate authority to subordinates. The manager may not be able to identify the areas where delegation is required. He may not even be able to identify the areas where delegation is required. He may not even be able to chalk out the proper process of delegation. The lack of competence on the part of superior restricts the delegation of authority.

## 15.7 OBSTACLES TO DELEGATION

The following are some of the reasons for an executives reluctance to delegate to his subordinates -

- 1. The dominance desire:** The desire to dominate, which is very strong in certain executives, unconsciously restricts such executives ability to delegate.
- 2. Fear of Incompetency:** The subconscious fear that subordinate will prove superior to the executive himself prevents such an executive from delegating.
- 3. Lack of confidence:** A third possible reason is lack of confidence in the subordinate which may be subjective and almost unconscious. This is a result of acceptance of the "indispensible man" theory.
- 4. Intolerance towards Ambiguity:** The executive may be handicapped by a temperamental aversion to taking a chance.

## 15.8 TEN COMMANDMENTS OF EFFECTIVE DELEGATION

The following principles may be considered as essentials for effective delegation of authority -

- 1. Delegate by Results expected:** The assignments should be defined and authority must be delegated in light of results desire.
- 2. Select appropriate subordinate for delegation:** The subordinate should be selected in the light of the work to be achieved. The delegation will be influenced by the qualifications of persons. This is the purpose of the managerial function of staffing and must be carefully considered.
- 3. Maintain parity of authority and responsibility:** Authority should be delegated commensurate with responsibility. This is on the assumption that where subordinates are held responsible for performance of certain duties.
- 4. Ensure unity of command:** This is one of the common principles of organisation advocated by Henry Fayol which stresses that each subordinate should have only one boss to whom he should be

accountable to avoid confusion and friction. Of course, in practice, it is not always possible to follow this principle.

**5. Maintain adequate communication:** There should be free and continuous flow of information between the superior and the subordinate with a view to furnish the subordinate with relevant information to help him make decisions and also to interpret properly the authority delegated to him. Plans may change and decisions have to be taken in the light of the changed conditions.

**6. Establish proper control:** Since the manager is primarily accountable to his superiors, it is necessary to make sure that the authority delegated is properly utilised.

**7. Reward Effective Delegation:** Effective delegation and successful assumption of authority must be rewarded. This will provide a proper environmental climate for fuller delegation and effective assumption of authority.

**8. Establish a climate of confidence:** The subordinate to whom authority is delegated, must mentally feel free from fear and have a feeling of confidence that delegation will not result in punishment but is an opportunity for his own self - development and growth.

**9. Establish a strong belief in delegation:** For delegation to be successful the manager who delegates must himself be convinced of the need and benefits of delegation. He must also be willing to allow his subordinates to make mistakes although he can be stricter when the same mistake is repeated.

**10. Help the subordinate:** The executive who delegates must watch the subordinate, not as a policeman, but as a friend or helper. Whenever assistance is required, it should be readily forthcoming.

## 15.9 NATURE OF DECENTRALISATION

**Definition:** The decentralisation of authority may be defined as a position where the ultimate authority to command or control as well as the ultimate responsibility for result is placed as far down in the organisation as in conformance with the efficient management of the enterprise.

**Nature:** In organising, a highly important concept related to the question of delegation is the extent of centralisation or decentralisation of authority in a particular organisational structure. Centralisation in this context refers to concentration of authority whilst decentralisation expresses greater dispersion of authority in actual practice, there is some decentralisation of authority in every organisation as otherwise there cannot be a structure with management hierarchical levels.

## 15.11 CENTRALISATION Vs DECENTRALISATION

Considerable debate has taken place over the years over the issue of 'centralisation' which means that the authority for most decisions is concentrated at the top of the managerial hierarchy versus 'decentralisation' which requires such authority to be dispersed by extension and delegation throughout all levels of management. There are advantages and disadvantages of both types of structure and pure form centralisation is not practical except in small companies and pure form of decentralisation almost never exists. However, the organisational structure would determine the degree of centralisation or the degree of decentralisation.

As the organisations grow bigger by expansion, mergers of acquisitions, decentralisation becomes both necessary and practical. If an automobile manufacturing company acquires a company which makes refrigerators, then decentralisation would be the natural outcome since policies and decisions in these two areas may not be similar.

## 15.11 BENEFITS OF DECENTRALISATION

Decentralisation and centralisation both enjoy certain benefits and corresponding defects. Some of the advantages of decentralisation are as follows.

**1. Relieves Higher Executives:** A decentralised organisation structure requires delegation of authority which relieves the top managers of their routine work. This is an answer to the problem of expanding the size of a business. Top executives can concentrate more on important decisions relating to planning for the future whilst delegating the operating decisions to self-contained units with competent managers in charge of each such unit.

**2. Facilitates Managerial Development:** It encourages the development of generalists, facilitating succession into the position of general managers. Expansion of business requires the production of the generalist type of managers who can co-ordinate the several activities and perform the managerial function of planning, organising, staffing, motivating and controlling.

**3. Fasters co-ordination:** It results in the promotion of intimate personalities and relationships which result in greater employee co-ordination and enthusiasm. Here greater co-ordination is secured at divisional levels where all the activities necessary are grouped.

**4. Facilitates Control:** The profit centre concept can be used for controlling divisional operations by measuring performance against the standard of profits generated by such divisions. The divisional manager's efficiency can be evaluated in terms of the returns on investment concept. In this way, competition can be fastened among the divisions.

**5. Encourages greater Efficiency:** The competitive atmosphere inculcated by the profit center concept increases the efficiency of the divisions. Besides, trouble spots can be located and remedied more easily, which also results in an increase of efficiency.

**6. Infuses Maximum Motivation:** By placing greater decision making power on managers down the line, initiative is promoted and the managers are motivated to higher performance.

## 15.12 PROBLEMS AND DISADVANTAGES OF DECENTRALISATION

The following are some of the limitations and problems faced by decentralisation.

**1. Increased Costs:** Unless the business size is large enough, the overhead costs of decentralisation would be relatively too heavy as each division has to be a self-contained unit with all the service function available within the division. This naturally results in duplication of functions with result uneconomic use of resource.

**2. Need for generalist manager:** For success in decentralisation, it is necessary to have capable executives with general management ability as the decentralised organisation has to place great reliance on the divisional manager's effectiveness.

**3. Greater need for control at policy level:** The independence generated by decentralisation requires adequate establishment of policies at the centralised level. Too much of such control may result in less decentralisation. Inadequacy of controls have forced certain organisations to recentralize the operations.

### 15.13 FACTORS DETERMINING THE EXTENT OF DECENTRALISATION

The following are, therefore, the important factors which determine the extent of decentralisation of authority which is considered desirable for a particular organisation.

**1. Size and complexity of the organisation:** Large organisations with diverse product line and conglomerates with companies involved in different fields would find centralisation to be more effective due to limitations in managerial expertise as well as increased executive work load.

**2. High costs of decisions:** The more expensive or costly the action to be decided upon, the chances are that it will be decided at the higher levels of management. Thus the decision of whether to have another factory or not would be taken at the top levels, whilst the question of purchasing of stationary would be taken at an extremely low level.

**3. Highly differentiated product lines:** where the product lines in a company are very different the extreme case being of industrial and consumer products both existing in the same company - decentralisation or divisionalisation becomes very important.

**4. Availability of Managerial Manpower:** Decentralisation of authority requires the availability of competent managers. The organisation must provide adequate training and development facilities for managers and decentralisation is one of the good methods of encouraging such development. A large firm can even decentralise with the objective of developing managers.

**5. Top level Management Philosophy:** A subordinate generally copies his boss. Thus the whole organisation is often moulded round the character of the top management. The management philosophy of top management determines to a large extent how much the several managers in the organisation are willing to retain authority or delegate it down the line.

**6. Environmental influences:** The contingency theory of organisation stresses that an organisation's structure and functioning are dependent on its interface with the external environment. The external factors relate to dealing with labour unions, community officials, lobbying in the government or matters relating to defence contracts etc. These factors necessitate centralisation.

### 15.14 SUMMARY

Delegation is an administrative process of getting things done by others by giving them responsibility. All important decisions are taken at top level by Board of Directors. The execution is entrusted to Chief Executive. The chief executive assigns the work to departmental managers who in turn delegate the authority to their subordinates. Further, decentralisation of authority as a position where the ultimate authority to command or control as well as the ultimate responsibility for results is placed as far down in the organisation. Thus delegation and decentralisation are related concepts.



## **15.15 SELF - ASSESSMENT QUESTIONS**

### **Essay Type**

1. What are the elements of delegation. Explain its advantages and disadvantages.
2. Discuss delegation of authority. What are the different types of delegation.
3. Why should authority be delegated? Point out the difficulties in delegation.
4. What do you mean by delegation of authority? Which factors determine the delegation of authority.
5. Discuss the centralisation - decentralisation issue with its pros and cons.
6. Under what situations decentralisation is desirable?

## **15.16 REFERENCE BOOKS**

1. Drucker, Peter, *"The Practice of Management"*, Harper & Row, PP. 225-226.
2. Allen, Lovis A., *Management and Organisation*, Mc Graw Hill, New Delhi - 1978.
3. Rustom S. Dallon *"The Management Process"*. Progressive Corporation Private Ltd. 1978.

**- Dr. D. NAGESWARA RAO**

## **Lesson - 16**

# **LINE & STAFF POSITION - REASONS FOR CONFLICTS - COMMITTEES**

## **16.0 OBJECTIVES**

The main objective of this lesson is to understand the line and staff relations and why the conflicts are arised between them. Moreover, to know how to resolve the conflicts between them. Further, we learn the need for committees and its advantages and disadvantages. And to know how to make committees effective.

## **Structure**

- 16.1 Introduction**
- 16.2 Types of Organisation**
- 16.3 (A) Line Organisation**
- 16.4 Types of Line Organisation**
- 16.5 Merits of Line Organisation**
- 16.6 Demerits of Line Organisation**
- 16.7 (B) Staff Organisation**
- 16.8 Types of Staff Organisation**
- 16.9 Advantages of Staff Organisation**
- 16.10 Disadvantages of Staff Organisation**
- 16.11 Line and Staff Organisation**
- 16.12 Advantages of Lion and Staff Organisation**
- 16.13 Disadvantages of Lion and Staff organisation**
- 16.14 Line and Staff Conflicts**
- 16.15 Resolving of Line and Staff Conflict**
- 16.16 Committee form of Organisation**
- 16.17 Need for Committees**
- 16.18 Types of Committees**
- 16.19 Advantages of Committee form of Organisation**
- 16.20 WEakness of Committee form of Organisation**
- 16.21 How to make Committees Effective**
- 16.22 Summary**
- 16.23 Self - Assessment Questions**
- 16.24 Reference Books**

## **16.1 INTRODUCTION**

While developing a sound organisation structure, it is important to understand not only the nature of the authority delegated but also the authority relationships which exit between managers among themselves, and between managers and subordinates. This involves an appreciation of (1) the line staff relationships, which have caused considerable misunderstanding and confusion in practice; (2) the use of committees and the organisational relationshis so created; and (3) the technical tools such as charting, which would help a better appreciation of the existing organisational relationships. Hence, this lesson explains all the above things in detail.

## 16.2 TYPES OF ORGANISATION

An organisational structure is mainly concerned with the allocation of duties and responsibilities and delegation of authority. It represents hierarchical arrangement of various positions in the organisation. The following are some of the important forms or types of organisation:

- A. Line Organisation.
- B. Staff or Functional Organisation
- C. Line and Staff Organisation
- D. Committee form of Organisation

## 16.3 LINE ORGANISATION

Line organisation is the basic framework for whole organisation. It represents a direct vertical relationship through which authority flows. This is the simplest and oldest, known as chain of command or scalar principles. The authority flows from top to the lower levels.

In words of **J.M Lundy**, "It is characterised by direct lines of authority flowing from the top to the bottom of the organisational hierarchy and lines of responsibility flowing in an opposite but equally direct manner.

This form of organisation is followed in military establishments. The commander-in-chief is at the top with various other officers at the lower levels. The officers at downward positions drive authority from top. The modern military organisations do not entirely rely on line organisation. They have staff wings like intelligence, medical and so on.

## 16.4 TYPES OF LINE ORGANISATION

The Line organisation is of two types:

- (a) Pure Line Organisation
- (b) Departmental Line Organisation

**a) Pure Line Organisation:** In pure line organisation all persons at a given level perform the same type of work. The divisions are solely for the purpose of control and direction.

The following figure gives an idea of pure line organisation.

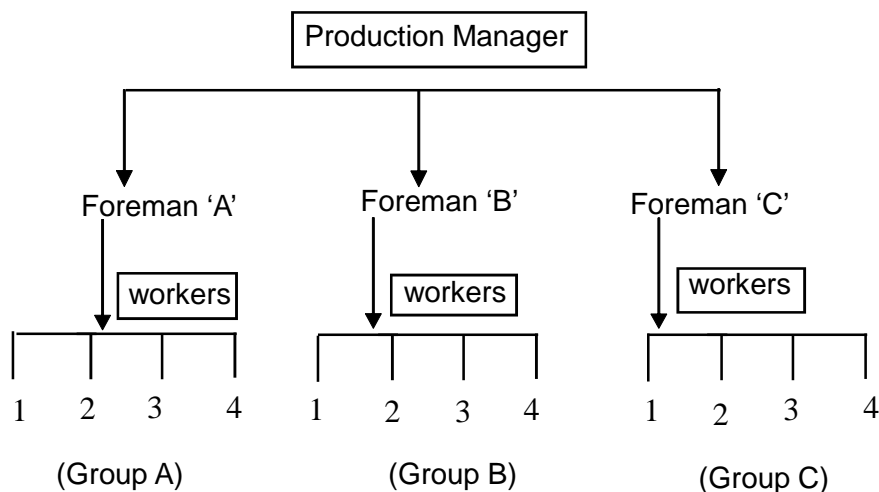

**B. Departmental Line Organisation:** This type of line organisation divides the enterprise into different departments which are convenient for control purposes. There is a unity on control and line of authority flows from top to the bottom. The whole organisation is put under the overall control of chief executive who may be called by the name of General Manager.

Different departments are put under the control of departmental managers. Departmental managers get orders directly from the General Manager. The managers are not dependent upon each other. Every department has its own line of organisation.

## 16.5 MERITS OF LINE ORGANISATION

**(A) Simplicity:** Line organisation is simple to establish and can be easily understood by the employees. Everybody knows his work and also to whom he is responsible. So it be operated simply and clearly.

**(B) Quick Decisions:** Only one person is incharge of a department or divisions.

**(C) Clear-cut of authority and responsibility:** Responsibility, authority and accountability are all clear-cut, easily assignable and traceable.

**(D) Effective Communication:** Communication is fast and easy and feedback can be acted upon faster.

**(E) Co-Ordination:** The hierarchy in management helps in achieving effective co-ordination. The general manager is incharge of all the departments and he can easily co-ordinate the work of various departments.

**(F) Flexibility:** Since the manager has to take all important decisions, he can make changes if new situation warrants. He can take a decision according to the requirements of the situation.

**(G) Unity of Command:** In line organisation every person is under the command of one boss only. The type of organisation is in accordance with the principle of scalar chain.

## 16.6 DEMERITS OF LINE ORGANISATION

**(A) Rigid and inflexible:** It is a rigid and inflexible form of organisation and there is a tendency for line authority to become dictatorial.

**(B) Instability:** The business is dependent upon some key persons and the sudden disappearance of such persons from the scene may create instability in the business.

**(C) Favouritism:** There is scope for favouritism in line organisation. The officers work according to their whims and preferences. They judge the performance of persons according to their own likings. They judge the performance of persons according to their own yard sticks. There is a likelihood that some persons may be given followers and deserving persons, on the other hand, may be ignored.

**(D) Lack of specialisation:** The lack of managerial specialisation is the demerit of line organisation. The line officers cannot be experts in every line of business. Therefore, the line officers will have to depend heavily on subordinates for advice.

## 16.7 STAFF ORGANISATION (FUNCTIONAL ORGANISATION)

**F.W. Taylor**, Father of Scientific Management, developed the concept of functional organisation. He recommended functional organisation even at the shop level where workers have to produce goods.

He thought that one foreman could not manage all the aspects of production work for directing a group of employees as they could not have varied knowledge. He suggested the substitution of line authority by functional foremanship at the lower levels of the organisation structure.

## 16.8 TYPES OF STAFF ORGANISATION

**Taylor** suggested the division of supervisory functions into two groups, viz., (1) office specialists and (2) shop specialists.

**1. Office Specialists:** They are concerned with the design, scheduling, recording and planning of work. The office staff consists of following persons: (a) Route clerk (b) Instruction card clerk (c) Time and cost clerk and (d) Disciplinarian.

**2. Shop specialists:** They guide and supervise the work in the factory. The following are the shop specialists: (a) Gang boss (b) Speed boss (c) Repair boss and (d) Inspector.

## 16.9 ADVANTAGES OF STAFF ORGANISATION

The staff organisation has the following advantages:

**(A) Economy of operations:** The use of specialists helps in controlling the waste of materials, money and time. The consolidation of activities leads to optimum use of facilities like office accommodation, plant and machinery, etc.

**(B) Relief to Top Executives:** Top executives are not unnecessarily burdened or happens in line organisation. The line officer is supposed to be a jack of all trades and is burdened with all types of works. On the contrary a specialist is a matter of his line and he has the expertise and capability of taking his own decisions.

**(C) Better Supervision:** Every superior is an expert in his own area and he will be successful in making proper planning and execution. The superiors being well acquainted with the work, they will be able to improve the level of supervision.

**(D) Democratic control:** This type of organisation eliminates one man control. There will be a joint control and supervision in the organisation.

**(E) Scope for growth:** The staff organisation provides wide scope for growth and mass production. The employment of specialists at various level of work enables the organisation to grow as per the needs of the situation.

**(F) Flexibility:** This organisation allows changes in organisation without disturbing the whole work. The span of supervision can also be adjusted according to the requirement.

## 16.10 DISADVANTAGES OF STAFF ORGANISATION

**(A) Group Rivalaries:** The emergence of many persons of equal status encourage group rivalaries among executives. Persons connected with different fields try to create their groups and then rivalry starts among these groups. Every group tries to dominate the order. The growth of the unit is adversely affected in a vicious atmosphere.

**(B) Lack of Co-ordination:** The appointment of several specialists creates problems of co-ordination, especially when the advice of more than one is needed for taking decisions. This created conflicts among specialists and co-ordination becomes a problem.

**(C) Conflict in Authority:** The principles of 'unit of command' is violated in functional organisation. A subordinate is answerable to many bosses. Every superior considers his work important and wants the workers to give top priority to his assignment.

**(D) Poor Discipline:** The division of authority creates problems of discipline. The workers have to obey many bosses, their loyalty becomes divided. Discipline tends to break down not only among workers but also among lower level supervisors.

**(E) Expensive:** Multiplicity of experts increases overhead expenses of the organisation. Therefore small units cannot afford to have functional organisation.

## 16.11 LINE AND STAFF ORGANISATION

Both line and staff organisations suffer from same drawbacks. On the other hand, line organisation is autocratic and staff organisation, on the other hand, has loose control. Line and staff organisation eliminates the drawbacks of both and also has the good points of them. It is a happy blending of line and staff organisations. Both line and staff personnel have important roles today. This organisation owes its birth to the army. A commander in the field is assisted by staff officers in planning and executing his strategies. He will like to know the position of his enemies so that he is able to plan his own placings. Staff officer helps the commander in all aspects of his job.

A line manager is vested with executive authority. He is responsible for making important decisions and is also accountable for their implications. Line officers are responsible for the accomplishment of various objectives. The authority flows vertically from top to bottom. The staff organisation facilitates the accomplishment of organisational objectives by making available valuable advice and expert knowledge. Staff officers may be asked to suggest solutions to various problems entrusted by line officers. They have no authority to command the line staff but have control within their own organisations.

## 16.12 ADVANTAGES OF LINE AND STAFF ORGANISATION

This organisation has the following advantages.

**(A) Balanced and Prompt Decisions:** The functional managers have the advantage of expert advice when taking important decisions. The staff can also be used to investigate and advice on inter-departmental relationships. The line officers can take balanced and quick decisions.

**(B) Quick Actions:** The line officers will have sufficient time to take various decisions. Whenever there is a need for certain decisions, they will be able to devote time and decide the things. This type of situation helps in solving many issues which would have created difficulties if timely decisions would not have been taken.

**(C) Specialisation:** Line and staff organisation introduced specialisation in a systematic manner. Persons with specialised knowledge are pointed to help line officers. The planning part is generally undertaken by staff personnel and line officers are able to devote much time for execution.

**(D) Growth and Expansion:** The line and staff organisation is quite suitable for growth and expansion. The burden of line staff is eased by the appointment of specialists. Line officers will be able to devote much time for future planning. The present staff will enable the expansion and growth of unit.

### **16.13 DISADVANTAGES OF LINE AND STAFF ORGANISATION**

**(A) Expensive:** This type of organisation is very expensive because a large number of specialists are appointed. The persons being experts in their fields, they demand higher emoluments. Therefore, small and medium concerns cannot afford line and staff organisation because of its expensive nature.

**(B) More dependence on staff:** The line officers become habituated for advice on staff. They refer everything to staff for advice. Over-dependence on staff will make line officers less creative. They will not give much thought to any activity since advice will be available from staff.

**(C) Ineffective Staff:** The staff officers do not wield any power in the organisation. Without power they will not get prestige in the organisation. They will feel unimportant and the quality of advice will also be adversely affected.

**(D) Conflict between line and staff personnel:** There is a possibility of conflict between line and staff personnel. The responsibility for operations lies with line officers while staff officers only advice. The staff officers feel ignored at the hands of line officers. The line officers, on the other hand, complain of interference by staff persons in the day-to-day working. The conflict between line and staff officials adversely affects the work in the organisation.

### **16.14 LINE AND STAFF CONFLICTS**

Line and Staff structure is based on the assumption that both will help and support each other. But often there are conflicts between the two and both accuse each other. There is a lack of understanding and both try to dominate each other. Some of the reasons of conflict between the two are as follows.

#### **(I) Line managers have the following complaints against staff**

- a) Staff officers claim credit for programmes which are successful but do not want to share responsibility for their failure.
- b) Staff officers are more theoretical than practical.
- c) Staff officers do not remain contented by giving advice only. They try to persuade the line for implementing whatever they have suggested. They trespass their field of activity and enter the area meant for line people.
- d) Though staff officers are well qualified and have good knowledge of their field but try to dominate line officers. They feel themselves superior to line officer.

#### **II. Staff personnel have the following complaints:**

- a) Line officers do not make proper use of expert knowledge of the staff.
- b) Staff people feel that their advice is not properly implemented by the line personnel.
- c) Line officers are not generally enthusiastic about the new ideas suggested by the staff. They resist new things and insist on following the traditions.

d) Staff officers do not have authority to implement their ideas. They should be given authority like line officers in supervising the implementation of their suggestions.

## 16.15 RESOLVING OF LINE STAFF CONFLICTS

The following are some of the ways in which conflicts between line and staff can be resolved or minimised.

**1. Remove the “Halo” effect:** Both line and staff executives must understand their respective importance and relationships. Overbearing attitudes on both sides should be removed.

**2. Adopt a more patient attitude:** Staff men should avoid being impatient when the line does not seem to understand and line management should be more patient when it thinks that the staff is impractical.

**3. Assume a helpful attitude:** Staff men should gain the confidence of line executives by adopting a helpful attitude and not an attitude of overbearance. They must see the problems as line men see them. They must try and find out from the line managers what their problems are and then try to help solve them without seeming superior.

**4. Avoid playing the expert:** The staff person should not play the role of an expert. He must show sincere regard for the abilities of the line manager who may not possess the same academic background.

**5. Speak the language of the Hearer:** Staff men who are experts often talk in their technical language which line men do not understand. This causes resentment and creates a mental barrier in the line manager who through resentment refuses to understand the staff men. Every technical man has his own jargon which must be played down while speaking to line management.

**6. Remove the Egar complex:** As some staff men are nearer top management than the line managers they advise, line managers often feel frustrated and therefore resist staff suggestion. Thus staff men must try to show that by helping line managers become more productive the line manager concerned would get greater recognition or prominence.

Thus the resolving of conflicts between line and staff is really a question of developing the right attitude in both line and staff executives.

## 16.16 COMMITTEE FORM OF ORGANISATION

The committees are very common in the business world. The Board of Directors is an example of a committee. A number of persons may come together to take a decision, decide a course of action, advise line officers on some matters, it is a committee form of organisation. It is a method of collective thinking, corporate judgement and common decision. But it is a method of attaching persons or groups to line departments for advice and guidance in business planning and execution.

## 16.17 NEED FOR COMMITTEES

The main reason for committees is to secure common judgement on administrative matters. The committees are set up for the following reasons.



1. The committees provide a forum for exchanging ideas among organisation members.
2. The exchange of ideas among members may generate some suggestions and recommendations which may be useful for the organisation.
3. There can be proper discussion on present problems and efforts are made to find solutions.
4. The committees may also be needed in establishing and developing organisational policies.

## 16.18 TYPES OF COMMITTEES

Different committees may be formed with different ideas and purposes. Some committees may be only advisory while some may perform managerial functions. There may be following types of committees.

- 1. Formal and Informal Committees:** If a committee is formed as a part of organisation structure and is delegated some duties and authority it is a formal committee. An informal committee may be formed to tackle some problems. The chief executive may call a meeting of departmental heads and some experts to find out a solution. In this case it is a case of an informal organisation.
- 2. Advisory Committees:** These are the committees to advise line heads on certain issues. Line officers may refer some problems or issues to a committee for advice. The committee will collect information about the problem and recommend solution for the same.
- 3. Line Committees:** There may be committees with managerial powers. Instead of giving work to one person it may be assigned to a number of executives. These committees also direct and control the activities of employees for achieving organisational goals.

## 16.19 ADVANTAGES OF COMMITTEE FORM ORGANISATION

- 1. Executive training:** Committees provide a good forum for training executives. They learn the value of intuition, group dynamics and human relations. They are exposed to various view points and learn the art of reaching decisions and solving organisational problems.
- 2. Better communication:** It is a better form for discussing matters of mutual interest and reaching certain conclusions. The members will transmit correct and authentic information and also convey the background of taking these decisions.
- 3. Motivation:** The committees consist of managers as well as subordinates. The views of subordinates are given recognition and importance. It gives them encouragement and makes them feel as an integral part of decision making process. Such committees boost the morale of subordinates and motivate them to improve their performance.
- 4. Better co-ordination:** Committee form of organisation brings more co-ordination among different segments of the organisation when representatives of different departments sit together.

## 16.20 WEAKNESS OF COMMITTEE FORM OF ORGANISATION

- 1. Lack of Effectiveness:** The role of committees is not effective in all areas. The committees may be useful where grievance redressal or inter personal departmental matters are concerned. Committees may not be effective where policies are to be framed and quick decisions are required.

**2. Domination by some members:** Some members try to dominate in the committee meetings. They try to thrust their view point on others. The aggressiveness of some members helps them to take majority with them and minority view is ignored.

**3. Delay:** The main drawback of committee form of organisation is delay in taking decisions. A number of persons express their view points in meetings and a lot of time is taken or reaching a decision.

**4. No Accountability:** No individual accountability can be fixed if these decisions are bad. Every member of the committee tries to defend himself by saying that he suggested a different solution. If accountability is not fixed then it is the weakness of the organisation.

## 16.21 HOW TO MAKE COMMITTEES EFFECTIVE

The defects of the committee system and the plural executive indicate that committees must be used appropriately. The following are suggestions for a more effective use of the committee system, namely.

**1. Choose an effective chairman:** The chairman plays a very important role in committee meetings, as he can guide the members and ensure that each one is permitted to express his view point without fear or fallow.

**2. Select suitable subject matter:** A plural executive is effective only in certain types of management functions. The subject matter for committees should, therefore, be limited to such areas. The subject matter should also be communicated in advance along with the agenda as already mentioned.

**3. Clearly define the scope and authority of the committee:** The members must know clearly what their authority is and the area in which they can arrive at decisions. They should also know whether they have line or staff authority.

**4. Reasonable number:** The number of members of committees should neither be too large nor too small. The number should be such which is essential for taking collective decisions. The number of members of committee with executive powers should not be more than 4 to 5 and advisory committees should be limited to 7 to 8 members. The reasonable number of committees will help in taking decisions quickly.

## 16.22 SUMMARY

Line organisation is the simplest type of organisation where the authority is embedded in the hierarchial structure and it flows in a direct line from the top of the managerial hierarchy down to different levels of managers and subordinates and down to the operative level of workers. It clearly identifies authority, responsibility and accountability at each level.

Line type of organisation, the functional specialists are added to the line, giving the line the advantages of specialists. This type of organisation is most common in our business economy and specially among large enterprises. Staff is basically advisory in nature and usually does not possess any command authority over line managers.

Line and staff structure is based on the assumption that both will help and support each other. But often there are conflicts between the two and both accuse each other. There is a lack of understanding and both try to dominate each other.

All the complaints of both line and staff personnel are based on lack of understanding. These conflicts are not based on ideologies. Proper demarcation of their fields and mutual trust can help in improving the efficiency of both line and staff personnel.

While many organisations have been successful due to only one person at the top making decisions, committees and task forces have become more and more necessary as the organisation grows into complexity. Because of collective information and analysis, committees are more likely to come up with solutions to complex problems.

Groups and committees have become an integral part of most organisations operations. Some of the disadvantages of committees can be eliminated and the committees can become more efficient and effective if some guidelines are established.

## **16.23 SELF ASSESSMENT QUESTIONS**

### **Essay type**

1. What do you understand by line organisation. Discuss the merits and demerits of line organisation.
2. What is meant by functional organisation? Describe its merits and demerits. How can it be made success?
3. What is line and staff organisation? What type of staff is used in this organisation? Describe the functions of staff authority.
4. What are the causes of conflicts between line and staff? How can this conflict be removed?
5. What is committee form of organisation? Why is it needed? Describe the advantages and weaknesses of this form.
6. Describe various steps for making committee form of organisation successful.

## **16.24 REFERENCE BOOKS**

1. Agarwal: *Organisation and Management*, Tata McGraw Hill, New Delhi, 2003.
2. J.S. Chandani; *Management Theory and Practice*, Vikas Publishing House Pvt. Ltd., New Delhi, 2004.
3. R.K. Sarma & S.K. Gupta, *Industrial Organisation and Management*, Kalyani Publishers, New Delhi, 2003.
4. Rustom S.Daur; *The Management Process*, Progressive Corporation Pvt. Ltd., Bombay - 1978.

**- Dr. D. NAGESWARA RAO**

## **Lesson - 17**

# **LEADERSHIP**

### **17.0 OBJECTIVES**

After completing this chapter, you should be able to know

- \* need for Leadership
- \* meaning and definition of Leadership
- \* functions of a Leader
- \* qualities of a good Leader
- \* theories of Leadership

### **Structure**

- 17.1 Introduction**
- 17.2 Meaning, Definitions**
- 17.3 Nature of Leadership**
- 17.4 Functions of Leadership**
- 17.5 Importance of Leadership**
- 17.6 Leadership Styles**
- 17.7 Theories of Leadership**
- 17.8 Leadership styles in Indian Organisations**
- 17.9 Summary**
- 17.10 Key Words**
- 17.11 Self - Assessment Questions**
- 17.12 Reference Books**

### **17.1 INTRODUCTION**

Good leadership is the soul of the organisation. Effective and successful leadership leads an organisation to achieve goals. Good leadership is essential for the success of a business because of

- (i) imperfect organisational structure
- (ii) occurrence of fast technical, economic and social changes,
- (iii) internal imbalances due to growth
- (iv) human nature and behaviour and
- (v) psychological reasons

### **17.2 MEANING**

Leadership is the process of influencing the behaviour of the people. Leaders are the moving spirits and guiding stars of inspiration to their followers. A leader interprets the objectives of the business, suggests course of actions and guides people to achieve the set objectives. He seeks active support and acceptance of the employees in the following the proposed course of action.

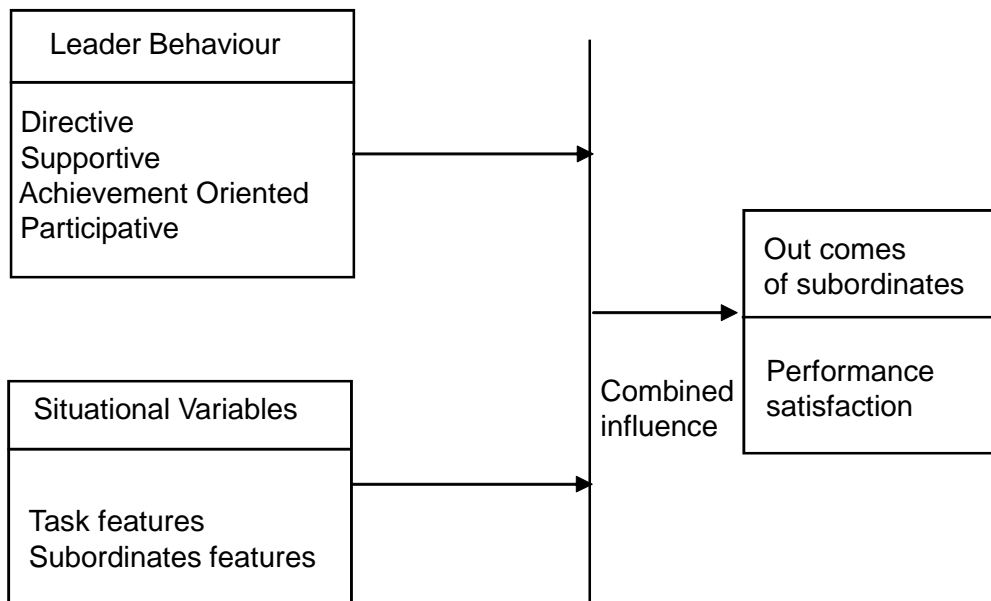

Fig. 17.1 The Leadership Process

### Definitions:

According to **Davis** “Leadership is the ability to persuade others to seek defined objectives enthusiastically. It is the human factor which binds a group together and motivates it towards goals”. Thus leadership is the process of influencing the activities of an individual or a group for goal achievement in a given situation.

**George R. Terry** “Leadership is the activity of influencing people of strive willingly for group objectives”.

This definition puts a direct emphasis on willingness on the part of the people led.

**Koonl z and O’ Donnel** have defined “Leadership as influencing people to follow the achievement of a common goal. It is the ability to exert interpersonal influence by means of communication towards achievement of a goal”.

## 17.3 NATURE OF LEADERSHIP

- (i) A leader must have followers. Lead whom? Leadership does not exist in vacuum. Leadership cannot exist without a group of followers.
- (ii) Leadership is a working relationship between the leader and his followers. This means that the leader must be an active participant in the activities of the group.
- (iii) The purpose of leadership is to achieve some common goal or goals. The process of influence and interaction is rational in the sense that it is goal - directed.
- (iv) A leader influences his followers willingly not try force or coercion. Leadership is not a bossism. A leader shows the way by his own example.
- (v) Leadership is a social interaction - influence process between the leader and his followers. It is an interpersonal process of influencing behaviour.

(vi) Leadership is a power relationship in which power and influence are unevenly distributed.

(vii) Leadership is a continuous and dynamic process of influencing behaviour. It is also a psychological process.

## 17.4 FUNCTIONS OF A LEADER

**17.4.1. Creation of objectives:** He creates the objectives and policies to lead the attention and efforts of his group in purposeful direction.

**17.4.2. Establishment of organisation:** He brings into existence the organisation to serve as the vehicle to accomplish the predetermined objectives and policies.

**17.4.3. Playing dominant role in action:** He initiates the various activities to promote the interests of the enterprise.

**17.4.4. Directing and motivating the subordinates:** He directs and stimulates his subordinates to work for the accomplishment of the enterprise goals and objectives. By issuing clear, complete and concise orders, he presents his followers with a challenge which they take pride in meeting effectively.

**17.4.5 Connection between management and workers:** He interprets the management policies and programmes to his subordinates and represents the subordinates interest before the management.

### Qualities of a good Leader

(i) Must have a good physical and mental personality.

(ii) Stability in his emotions.

(iii) Thorough understanding and better judgement and far sightedness.

(iv) Balanced approach and well behaved.

(v) Ability to guide and motivate subordinates.

(vi) Excellent communicating skill

(vii) Must be social

(viii) Technical superiority with sound general education and expertise.

(ix) Sincere, honest and fair dealing.

(x) Courage to accept responsibility.

## 17.5 IMPORTANCE OF LEADERSHIP

More failures of business concerns are attributable to poor leadership than any other cause. This emphasises the importance of leadership in achieving the organisational goals.

**17.5.1 Determination of goals:** A leader carries out the creative function of laying down goals and policies for the followers.

**17.5.2 Organisation of activities:** A good leader divides organisational activities among the employees in a systematic way. It helps to reduce the chance of conflict between them.

**17.5.3 Accomplishment of coordination:** A leader directs and unifies the efforts of the individuals of a group for the accomplishment of organisational goals.

**17.5.4 Providing guidance:** A good leader guides the subordinates and is available for advice whenever they face any problem.

**17.5.5 Building employees morale:** A good leader builds employees morale which in turn ensures high productivity and stability in the organisation.

**17.5.6 Facilitating change:** Dynamic leadership is the corner-stone of organisational change. A dynamic leader can facilitate change as he is able to overcome resistance to change on the part of the employees.

## 17.6 LEADERSHIP STYLES

Leadership style refers to a leader's behaviour. Behaviour pattern which the leader reflects in his role as a leader is often described as the style of leadership. It is the result of the philosophy, personality and experience of the leader.

**17.6.1. Autocratic or Authoritarian Leaders:** Under the autocratic leadership style (a) all decision making powers are centralised in the leader. (b) Leaders are dictators. (c) Leaders do not entertain any suggestions or initiative from subordinates. (d) They give orders and assign tasks without taking subordinates into confidence. (e) Leaders generally attract the hostility of the subordinates.

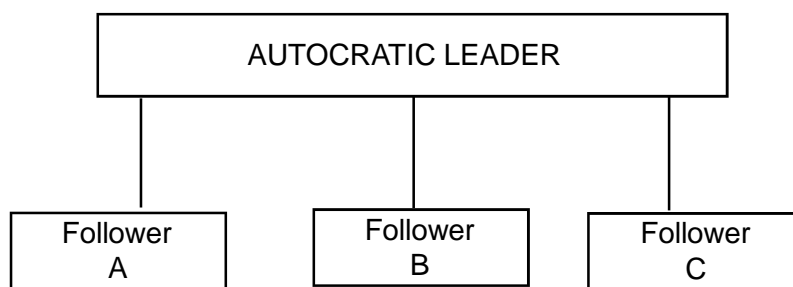

Fig. 17.2 Leadership styles: Autocratic leader

Actually an autocratic leader is, no leader. He is merely the formal head of his organisation. Workers under him feel harassed and disturbed and prepare themselves to offer resistance.

**17.6.2 Democratic leader:** (a) The democratic leadership style favours decision - among by the group. (b) He can win the cooperation of his group. (c) He can motivate them effectively and positively. (d) number of complaints, employees' grievances, industrial unrest and strikes can be reduced. (e) The decisions of the democratic leader are not unilateral.

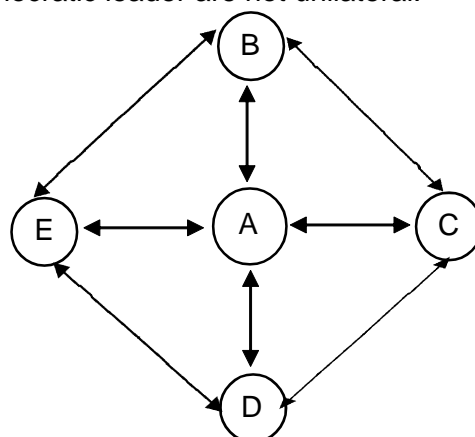

Fig: 17.3 Participative Leadership Style

Participation, consultation and agreement of the group members are important features of democratic leadership. Democratic functioning can at times be dilatory and subject to pulls and pressures from different groups. But considering the advantages offered by it, the weaknesses of the system are quite insignificant.

### 17.6.3. Laissez - Faire or Free - Rein Leader:

A free rein leader does not lead, but leaves the group entirely to itself.

leader allows maximum freedom to subordinates.

They are given a free hand in deciding their own policies and methods.

The leader acts as an empire and co-ordinator of information.

This type of leadership style is also known as the “permissive style of leadership, where there is least intervention by the leader.

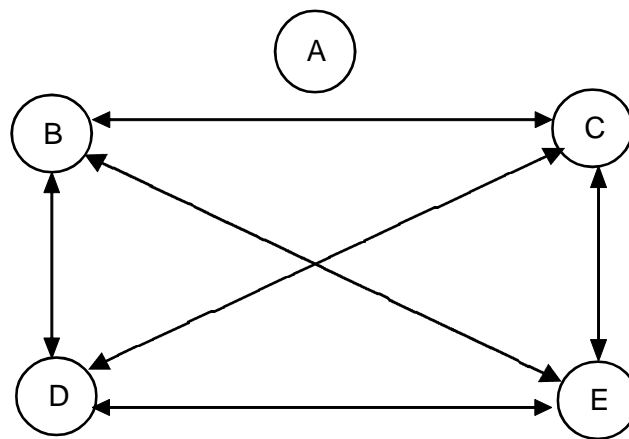

Fig: 17.4 Free rein Leadership style

This type of direction can produce good results if the subordinates are highly educated. Free rein leadership style is considered better than the authoritarian style. But it is not so effective as the democratic style.

**17.6.4. Intellectual or functional leader:** An intellectual or functional leader commands no authority in the formal sense of the term. But because of his technical knowledge and professional skills, many persons in the organisation look up to him for guidance and leadership.

Ex: Chemist, engineer, accountant, specialist in personnel matters can be regarded as intellectual or functional leaders.

**17.6.5 Institutional leader:** An institutional leader is one who, because of the prestige or privileges associated with his office, compels obedience from his subordinates. He may not be an expert in his field of activity, but his subordinates have to carry out his wishes.

**17.6.6 Paternalistic leader:** A paternalistic leader is one who because of his sentimental or emotional approach to things, is greatly concerned with the comfort and welfare of his subordinates. The thought of providing protection to them is uppermost in his mind.



Though well - meaning and well - intentioned, such a leader may not be liked by his subordinates for the simple reason that under him, their growth and advancement tend to get stifled. He is like that tree which gives protection to all about under which nothing can grow.

## 17.7 THEORIES OF LEADERSHIP

**17.7.1 Trait Theory:** This theory described by **Kelly (1974)** attempts to classify what personal characteristics such as physical, personality and mental, are associated with leadership success. Trait theory relies on research that relates various traits to the success of a leader. A lengthy list of traits has been made to describe an effective leader in terms of certain characteristics.

### **Classification of traits:**

1. Physical characteristics of the leader, such as age, height, weight.
  2. Background characteristics - education, social status, mobility and experinece.
  3. Intelligence - ability, judgement, knowledge.
  4. Personality - aggressiveness, alertness, dominance, decisiveness.
  5. Task oriented characteristics - achievement need, responsibility, initiative, persistence.
  6. Social characteristics, supervisory ability, cooperativeness, popularity, prestige, tact, diplomacy.
- Studies are researches prove that persons possessing above traits could became successful leaders.

### **Trait theory suffers from the following weakness:**

1. It has not been possible to identify universal or specific traits common to all leaders.
2. It does not make clear as to how much of any trait a person should have.
3. It emphasises mainly the personal traits and does not consider environment.
4. There cannot be generalisation of traits for a successful leader.
5. Trait studies describe, but do not analyze, behaviour patterns.

**17.7.2 Behavioural Theory of Leadership:** According to the behavioural approach, leadership is a function of effective role behaviour. An effective leader is are who performs those acts which help the group to achieve its objectives. Behavioural theory is based on three main models.

- a. The Michigan Studies
- b. The Ohio State University studies
- c. Mouton's Managerial Grid.

**The Michigan Studies:** Michigan researchers identified two leadership styles i.e. employee centred leader and production centred leader. A supervisor is considered as employee-centred if he allows the employees to handle most of the problems themselves. Production-oriented supervisor is concerned more with the task than with the people who perform the task.

**Table 17.1**

Employee-centred leader	Production centred leader
1. Treats employees as human beings	1. Treats employees as tools in the production process.
2. Shows concern for the welfare of workers	2. Emphasises production targets and technical aspects of the job
3. Encourages and involves employees in decision making	3. Exercises close supervision and control.

**Ohio State University Studies:** This studies identified the leadership behaviour - consideration and initiating structure. Consideration (C) refers to mutual trust, friendship and warmth between the leader and his staff. Initiating Structure (IS) implies the degree to which the activities of subordinates are defined and work procedures are established. The researchers used a Leader Opinion Questionnaire (LOQ) to systematise leader’s self-perception of the leadership style. A Leader Behaviour Description Questionnaire (LBDQ) was developed to be answered by the leaders.

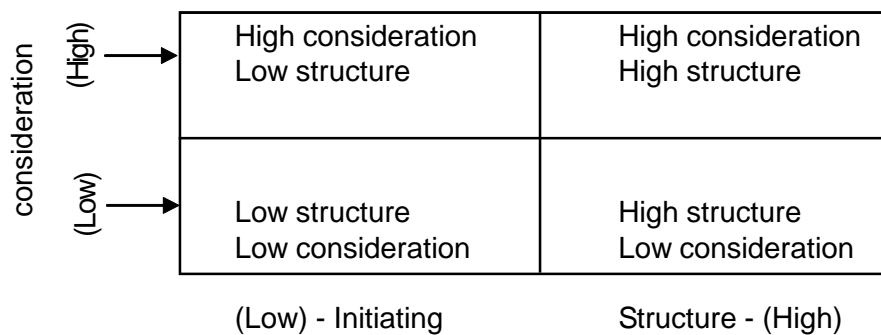

Fig 17.5 Leadership Quadrants

**The Managerial Grid: Blake and Mouton** have developed a grid to explain leader behaviour. They point out that leadership style is a blend a matrix wherein task-oriented and relations - oriented behaviour mix in different degrees to evolve the composite style.

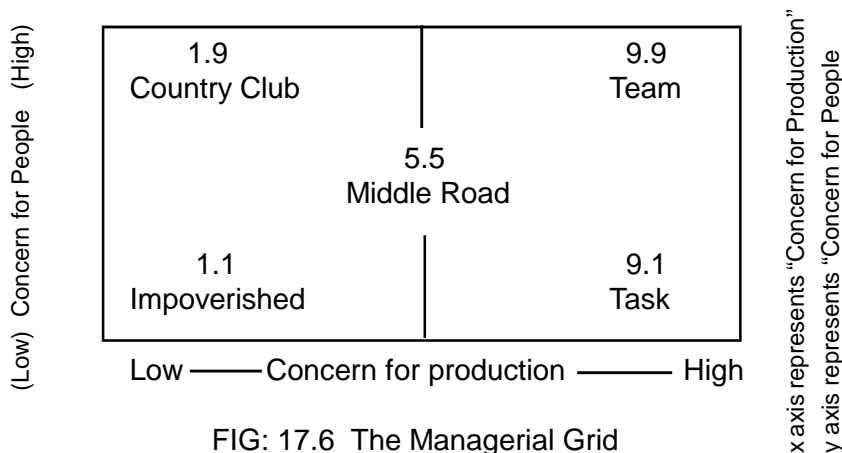

FIG: 17.6 The Managerial Grid

One is considered minimum while Nine is considered maximum on the continuum. Totally there are as many as 81 leadership styles but the most prominent ones are only five in number. They are:

- (i) **Impoverished Leadership Style (1.1)** Concerned neither production nor people.
- (ii) **Country club leadership style (1.9)** is concerned for people and only incidentally with production.
- (iii) **Task Leadership Style (9.1)** Primarily concerned about the task or production.
- (iv) **Team Leadership style (9.9)** Extremely concerned about the task and also the people.
- (v) **Middle of the road leadership style (5.5)** reflects a middle ground positions and is called as middle of the Road Management Leader.

**17.7.3 Group and Exchange Theory of Leadership:** This approach is based on social psychology. This theory says that leadership is an interpersonal influence. It is a positive exchange between the leader and followers in order to achieve group objectives. It is a two-way influence relationship. It indicates that subordinates affect leaders and their behaviours as much as leaders and their behaviours affect subordinates.

According to this leadership is an exchange process between the leader and followers. **Hollander and Julian** state "The very sustenance of leadership depends upon some yielding to influence on both sides".

#### **17.7.4 Situational Theory of Leadership**

##### **Features of Situational Theory:**

- a. Situation greatly influences leadership behaviour.
- b. Defines leadership as a process of influence.
- c. Leader emerges out of the situations.
- d. It examines the interplay among three components of leadership the leader, the follower, and the situation.
- e. It requires the leader to behave in a flexible manner.
- f. Effectiveness in leadership roles can be increased through education and training.
- g. Leader behaviour varies from one situation to other.

##### **Factors that determine the effective style of Leadership:**

- a. Leader Characteristic:** These include the leader's personality, needs, past experience, expectations and motivation.
- b. Followers Characteristics:** Important features to consider are the followers nature, his outlook, needs, experience, goals, values etc.
- c. Characteristics of the situation:** A leader should consider the complexity, cultural climate, time pressure, social impact, practicality of style, and new changes in the outer environment.

**d. Organisational characteristics:** The leader should consider the various aspects within the organisation, such as rules and policies, professionalism, objectives, task structure, managerial philosophy, work freedom, permissiveness etc.

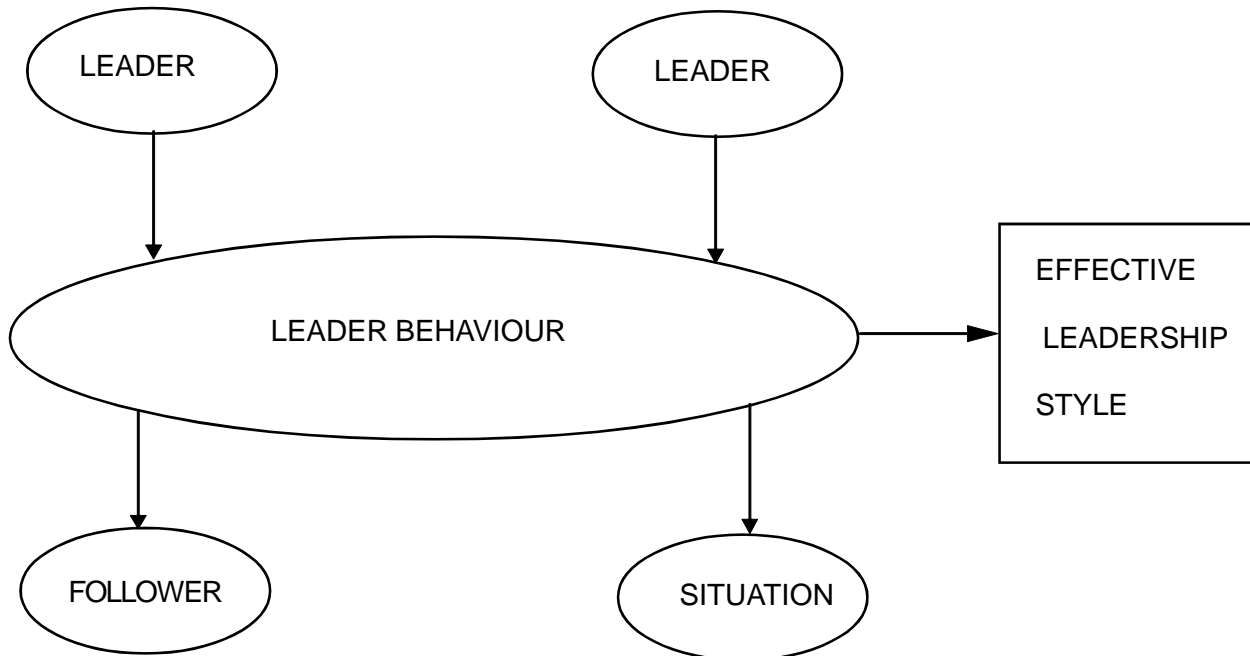

FIG: 17.7 Situation Approach to Leadership

## 17.8 LEADERSHIP STYLES IN INDIAN ORGANISATIONS

Since managerial styles are determined by a number of factors such as superiors, subordinates, and situations. It is unrealistic to expect a uniform leadership style. From this point of view, the Indian organisations can be classified into the following three categories.

- (a) Family - managed traditional organisations.
- (b) Professionally - managed Indian organisations and foreign-owned organisations.
- (c) Public sector organisations.

As all these organisations are of different in nature, they have some distinct leadership styles.

### (a) Family-managed Traditional Organisations

In these organisations the most prevalent style is autocratic. Sons and grandsons of the entrepreneurs are automatically promoted without any consideration to efficiency or overall suitability. Thus there is management by inheritance or management by chromosomes. As a result, these organisations become highly centralised in their structure and remain authoritarian in their approach.

### **(b) Professionally - managed Indian organisations and Foreign - owned organisations**

There are many organisations in the private section owned by Indian or multinationals who have appreciable degree of participation like the democratic leadership. The reason is that multinationals bring not only their technology but also the work culture which is more permissive and conducive for the application of modern approach of management. As such the degree of participation is very high in such organisation.

### **(c) Public sector organisations**

Owing to the work culture inherited by public sector managers, bureaucratic style is more prevalent in the public sector organisations. Initially, public sector organisations were manned by civil servants who brought a lot of bureaucratic culture with them. The net result is that all of the organisational processes are governed by the bureaucratic model. Its implications are: status differentials, class distinctions, and impersonal relationships which work against the participative style.

Most Indian top managers are relatively authoritarian in their relationship with lower management and labour. They are also employee oriented on account of Indian cultural and religious pattern. Then, what is the right leadership style for Indian managers is something that is difficult to answer. It all depends on numerous variables such as superiors, subordinates, and the situation under which a particular style is followed.

## **17.9 SUMMARY**

Leadership refers to the quality of the behaviour of individuals, where by they guide people on their activities in organised efforts. Leadership must have the "Do as you say" which requires motivating effects on the part of the leader. Competent leadership can help in integrating the human effort and their utilisation for constructive purpose. Autocratic, Consultative and Free-Rein are the three basic leadership styles. In nutshell, it can be said that it is an inter-personal, social and continuous process which influences group of persons towards a desired goal.

### **17.10 KEY WORDS**

- 1. Leadership:** Leadership is the process of directing and influencing the task related activities of the group members.
- 2. Transformational Leaders:** These leaders convert or change the positions of the followers. They transform the status of subordinates from good to better and bad to good.
- 3. Traits Approach:** This approach seeks to distinguish leaders from non leaders, based on the qualities and traits of the individuals.
- 4. Behavioural Approach:** This line of thought on leadership opines that some behavioural patterns or styles do differentiate leaders from non-leaders.
- 5. Contingency Approach:** This approach says that leadership is situational. Hence it differs from situation to situation.

### **17.11 SELF - ASSESSMENT QUESTIONS**

1. Define leadership. What are the characteristics of leadership?
2. Discuss the various styles of leadership?

3. What is leadership? Enumerate the qualities of a good leader.
4. Write short notes on the following approaches to leadership?
  - (a) Situational Theory
  - (b) Trait Theory
  - (c) Behavioural Approach
  - (d) Contingency Approach
5. Discuss Leadership Styles in Indian organisations.
6. Distinguish between autocratic and democratic style of leadership.

### **17.12 REFERENCE BOOKS**

VSP Rao and V. Hari Krishna, *Management Text and Cases*, Excell Publishers, New Delhi.

LM Prasad, *Management Principles and Practices*, Sultan Chand & Sons, New Delhi.

D. Chandra Bose, *Principles of Management and Administration*, Prentice-Hall of Indian Private td., New Delhi.

Harold Knootz and Heinz Wehrich, *Management Global Perspective*, Tata McGraw Hill Publishers, New Delhi.

**Dr. D. NAGESWARA RAO**

## Lesson - 18

# MOTIVATION PROCESS - TYPES OF INCENTIVES - PROBLEMS

## 18.0 OBJECTIVES

After completing this chapter, you should be able to know

- \* concept of motivation
- \* nature and essence of motivation
- \* theories of motivation
- \* various types of incentives
- \* how to motivate

## Structure

- 18.1 Introduction
- 18.2 Meaning and Concept
- 18.3 Nature of Motivation
- 18.4 Importance of Motivation
- 18.5 How to Motivate
- 18.6 What does demoralise?
- 18.7 Theories of Motivation
- 18.8 Types of Incentives
- 18.9 Morale and Performance
- 18.10 Summary
- 18.11 Key words
- 18.12 Self Assessment Questions
- 18.13 Reference Books

## 18.1 INTRODUCTION

Motivation is an integral part of the process of direction. In the course of direction, the manager has to try to create in his subordinates the willingness to pursue organisational goals.

Motivation inspires the workforce and creates confidence among them. Motivation deals with actuating the people to work for the accomplishment of enterprise goals.

## 18.2 MEANING AND CONCEPT

Motivation may be regarded as set of those wishes, desires, need and drives which stimulate or activate individual to act. Man is said to be motivated when his concealed energy is directed towards the accomplishment of certain goals. So from thus we can say motivation is the willingness of individuals to carry out plans more enthusiastically for achieving organisational goals.

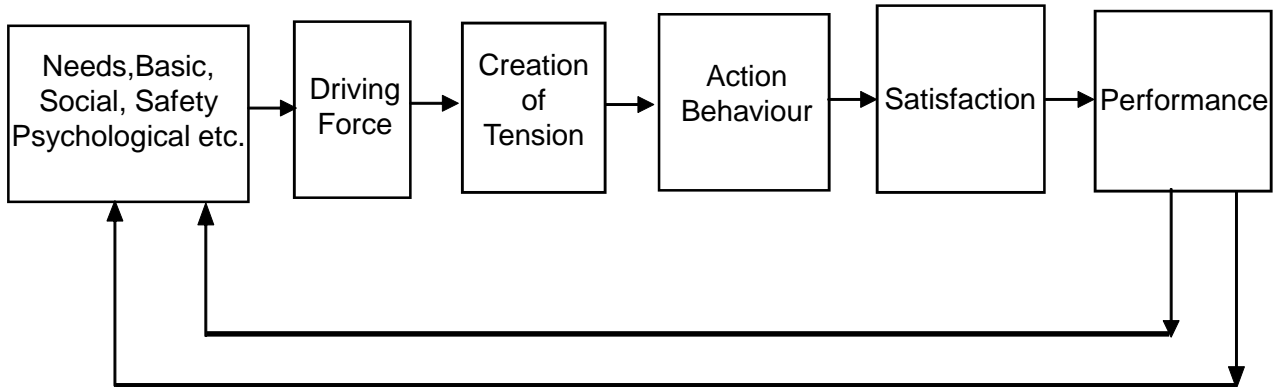

Fig. 18.1 Motivation Process

### 18.2.1 Definition of Motivation

**Stanely Vence** defines “Any emotion or desire which conditions one’s will that the individual is propelled into action”.

**Robert Dubin** says “The complex of forces starting and keeping a person at work in an organisation”.

**Encyclopedia of Management** “Motivation refers to the degree of rediness of an organism to pursue some designated goals and implies the determination of the nature and locus of force inducing degree of readiness”.

On the basis of above definitions we can say

- Motivation is a inner psychological force which activates and compels the person to behave in a particular manner.
- Motivation process is influenced by personality traits learning abilities, perception and competence of an individual.
- Motivation originates from the needs and wants of an individual.

### 18.3 NATURE OF MOTIVATION

- Motivation is a personal and internal feeling.
- Motivation produces goal-oriented behaviour.
- Motivation is a continuous process.
- Motivation is complex.
- Motivation is a system oriented
- Motivation can be either positive or negative.
- Motivation is different from job satisfaction.



## 18.4 IMPORTANCE OF MOTIVATION

Management has to create “will to work” among the subordinates. Thus, every superior in the organisation should motivate his subordinates for right types of behaviour.

**a. Helps in realising organisational goals:** Motivated employees cooperate voluntarily with the management and thus contribute their maximum towards the organisational goals.

**b. Helps in increasing productivity:** Motivation brings about satisfaction to employees, they work whole-heartedly. This results in increased productivity.

**c. Helps in reducing employees turnover and absenteeism:** The rate of turnover and absenteeism comes down on account of the attractive motivational schemes.

**d. Helps in maintaining good industrial relations:** A proper system of motivation reduces friction among the employees and between the employees and the management. This results in good industrial relations between the management and the employees.

**e. Helps in getting right personnel:** Attractive motivational schemes help in attracting highly talented and competent persons from external sources.

**f. Helps in reducing employees grievances:** Good motivational schemes also help in reducing the number of complaints and grievances.

**g. Motivation: Carrot and Stick Approach:** Desired behavioural pattern in the individual can be obtained in a positive or negative manner. If the person responds to positive motivations like: rewards, self discipline, promotions, transfers etc. It is called motivation due to carrots. Similarly, if the needed behaviour in the subordinate is brought about by negative measures like threats, force, compulsions, undue influence, punishments, coercion etc. It is motivation due to stick approach. It is all situational and a combination of the two also may be a good strategy.

## 18.5 HOW TO MOTIVATE

- \* by recognising the individual differences
- \* by matching the jobs with the people (or) vice-versa
- \* by using goals individualising the rewards.
- \* by linking rewards to performance
- \* by formulating good personnel policies.
- \* by adopting decentralisation and delegation of authority where ever it is needed.
- \* by maximising job satisfaction by job enrichment.
- \* by following systems like MBO and MBWA.
- \* by rewarding frankness and openness.

- \* by encouraging creativity of the personnel.
- \* by creating good organisational culture, climate and health.
- \* by improving employee morale etc.

## 18.6 WHAT DOES DEMORALISE?

Some times, motivational and morale aspects in an organisations are very poor due to some practices unwarranted. hence, it will be good, if they are avoided.

- a. Under assignments to people capable of doing though and takes of responsibility and risk.
- b. Over assignments to people beyond the capacity and commettence.
- c. Buckmastership: It is a practice where some superiors avoid doing hard works, pass it on to the lower level people and pending fault with them. This practice erodes employee motivation.
- d. Managers must not be manipulative and cohesive in their attitudes.

**18.6.1. Motivation Vs. Demotivation:** To motivate the subordinates and know the climate and atmosphere in the campus of the organisations, this distinction is highly needed.

### When is one said to be motivated?

- \* One comes to work willingly
- \* One gives the best of one's efforts at work.
- \* One has sense of belongingness and pride in associating with the organisation job.
- \* One is very much committed to work etc.

### 18.6.2 Demotivation is understood from

- \* high rates of absenteeism and personnel turn - over
- \* curtailed output / productivity
- \* increased number of accidents
- \* high wastages / defectives
- \* heavy loss due to bad handling
- \* rank indisipline
- \* frustrated workforce
- \* defiant and violent behaviour
- \* frequent confrontation and arguments with supervisors etc.

Demotivation causes variations in the behaviour of subordinates. This can be generated and may be presented in the following figure.

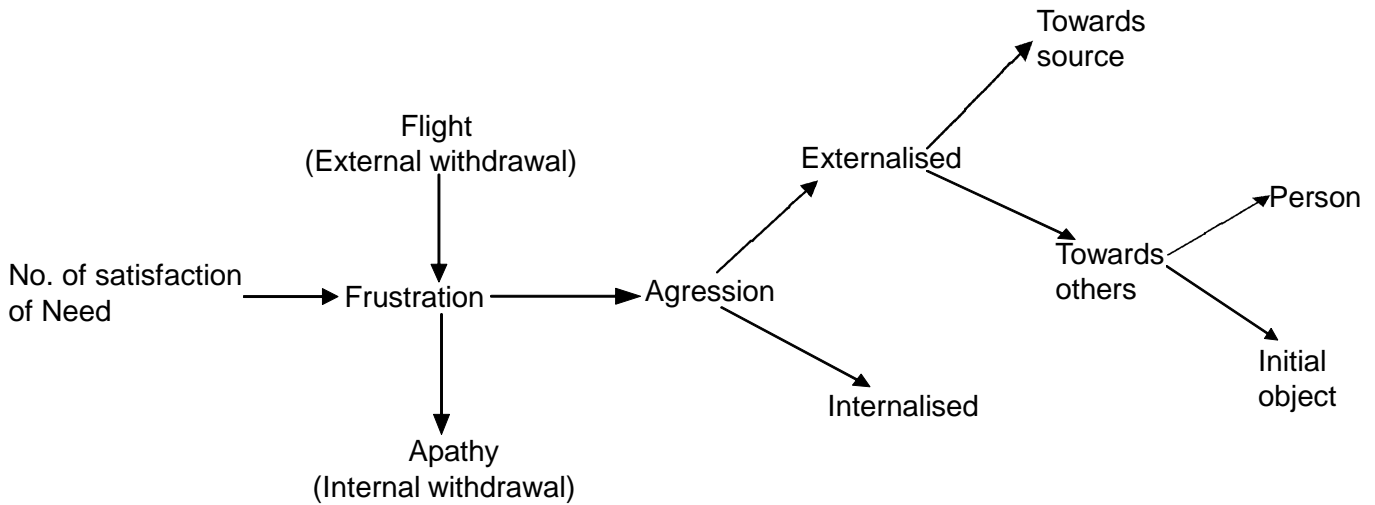

Fig. 18.2 Causes of Demotivation

**a. Flight** are way of handling a frustration is to leave the field or swithdraw from the scene.

**b. Apathy:** If an employee does not leave frustrating jobs, physically, he may remain absent psychologically.

**c. Aggression:** A more common reaction of frustration is aggression, an act against some are or some thing.

## 18.7 THEORIES ON MOTIVATION

1. Maslow's need Priority Model
2. Herzberg's Two Factor Theory
3. MC Gregor's Theory X and Theory Y
4. Ouchi's Theory 2
5. Mc Clelland's Need for Achievement Theory
6. Adams Equity Theory
7. Vroom's Expectancy Thoery
8. Alderfer's ERG Theory

**18.7.1 Maslow's Need Priority Model:** Abraham Maslow's need-hierarchy theory is one of the most popular and widely known theories of motivation. According to Maslow, people are motivated to satisfy five categories of needs. They are

Psychological needs

Safety needs

Social needs

Esteem needs

Self-actualisation needs

Which is represented through the following diagram

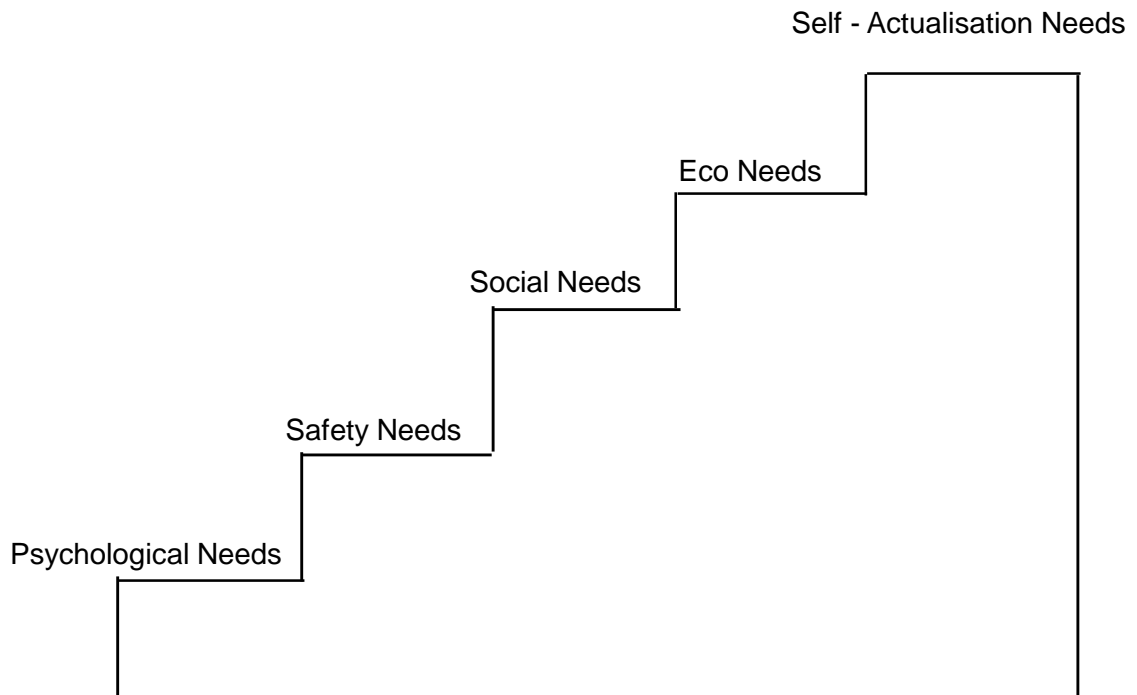

Fig. 18.3 Maslow's Need Hierarchy

- (i) **Psychological needs:** includes the need for food, water air and sex.
- (ii) **Safety needs:** Includes the need for security and stability as well as freedom from fear or threat.
- (iii) **Social needs:** includes need for friendship, affection acceptance and interaction with othes.
- (iv) **Esteem needs:** includes both a need for personal feelings of achievement or self-esteem and a need for recognition or respect from others.
- (v) **Self-actualisation needs:** includes feelings of self-fulfillment and the realisation of one's potential.

Maslow contended that a "lower" need must be relatively satisfied before the next "higher" need can motivate the person.

For Ex: A person's safety needs would have to be generally satisfied before the next level of need can motivate his behaviour.

Maslow believed that the drive to self actualise was universal, but that it is only rarely reached and never fully fulfilled.

### 18.7.1 (i) Merits or utility of Maslow's Classification of Needs

- (a) Maslow's theory suggested the priority and nature of needs.
- (b) This concept of needs is important for understanding the managerial task in relation of human resources working in organisation.
- (c) Maslow's approach is direct, simple and practical.
- (d) He pointed out that this hierarchy of needs is not rigid and fixed in order and it is not the same for all individual.

### 18.7.1 (ii) Weaknesses of Maslow's Theory:

It is a general expression not specific. The levels in the hierarchy are not rigidly fixed. The boundaries between them are hazy and overlapping.

It does not have any allowance for exceptions. This approach overlooks the interaction of needs.

### 18.7.2 Frederick Herzberg's Two Factor Theory:

This is also another needs theory **Herzberg** concentrated on two factors to explain employees motivation.

Managers have viewed job satisfaction and job dissatisfaction as opposite ends. **Herzberg** suggested that the opposite of satisfaction is not dissatisfaction but simply "no satisfaction".

Two factors of **Herzberg** are:

**(i) Motivators** i.e. factors that produced job satisfaction. It includes achievement, recognition, responsibility, advancement and personal growth.

**(ii) Dissatisfiers** led due to dissatisfaction in the job called as "Hygienes" which includes company policies and administration, supervision, working conditions pay and job security.

**Herzberg's** two factor theory can be explained in the following figure.

Based on this **Herzberg** concluded that only motivators produce job satisfaction, where as hygienes merely prevent job dissatisfaction.

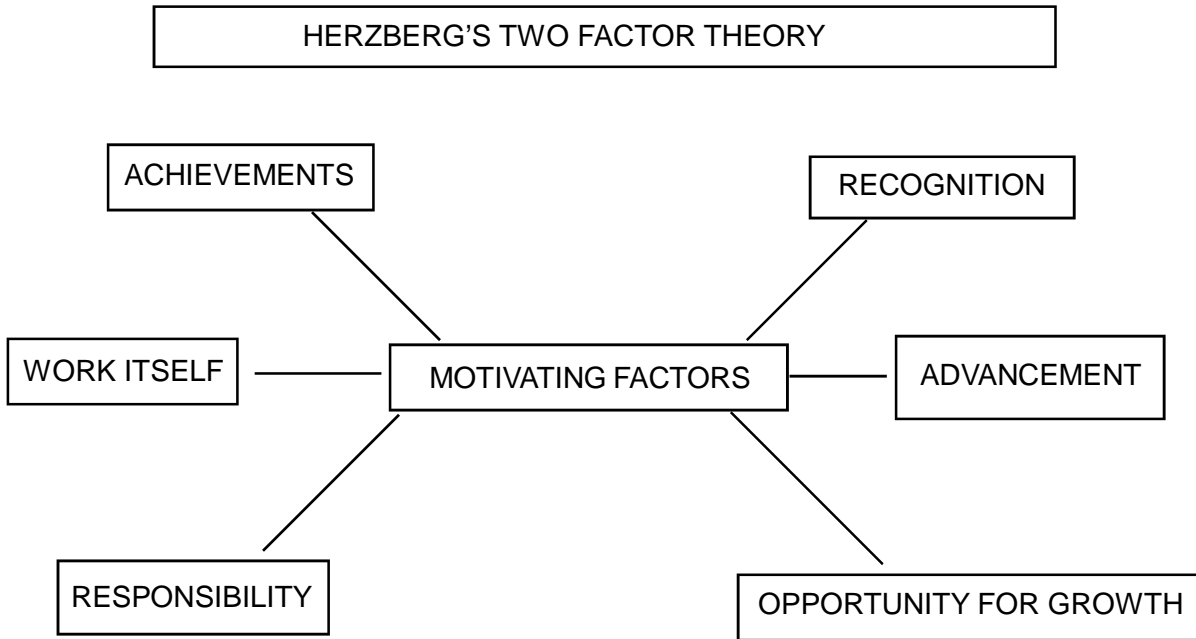
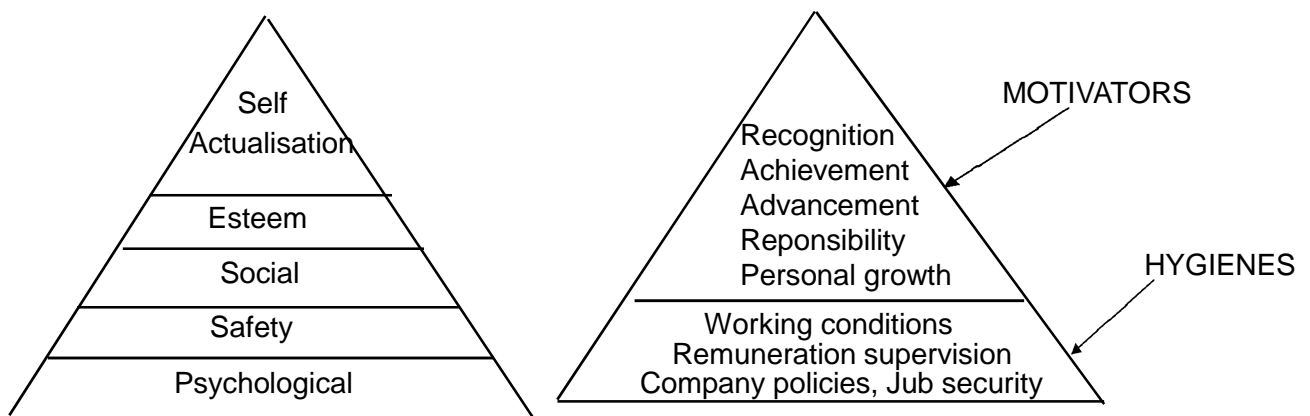

FIG.

Fig. 18.4

**HERZBERG'S MOTIVATORS AND HYGIENES**

<b>Motivators</b>		<b>Hygienes</b>	
1)	Recognition	1)	Working conditions
2)	Achievement	2)	Remuneration
3)	Responsibility	3)	Supervision
4)	Advancement	4)	Company policies
5)	Personal Growth	5)	Job security

**Table 18.1****A comparison of Maslow's need Hierarchy thoery and Herzberg's two factors theory****Fig. 18.5**

As shown in the above figure.

Herzberg's hygienes are equivalent to Maslow's three lowest needs.

Similarly, his motivators are roughly equivalent to Maslow's two highest needs.

Herzberg's two factor theory suggests that lower level needs are no longer strong, motivators, for employees. Rather today's employees are likely to be motivated by higher level needs such as esteem and self-actualisation.

**Table 18.2**  
**Maslow Vs Hergberg Models**

<b>Basis</b>	<b>Maslow Model</b>	<b>Hergberg Model</b>
Nature of Theory	Descriptive	Prescriptive
Proposition	Unsatisfied needs motivate persons	Satisfied needs regulate behaviour
Motivator	Any need can be a motivator, if it is not met	Only higher needs act as motivators
Applicability	It applies to all workers	It applies upper managerial personnel
Categories	It has five levels of needs	It has two classes of factors

**18.7.3 MC Gregor's Theory X and Theory Y:** Mc Gregor developed "Theory X" and "Theory Y" to explain human behaviour. He made two sets of assumptions which are quite opposite to one another.

The first set of assumption he called as "Theory X" considered to be traditional, autocratic and negative in approach,

While the second set of assumption better known as "theory y" is based on accomplishment, self motivation and is positive in approach.

**18.7.3 (i) Theory X Assumptions:**

- a. Workers have an aversion to work.
- b. Workers have an inherent dislike of work and will avoid it, if possible.
- c. Workers try to find a way to postpone the work of completion
- d. Workers may do the job half-heartedly.
- e. Fear of punishment can motivate the workers into action.
- f. Workers are not ready to accept responsibility.
- g. Most workers have little creativity.
- h. A workers prefers to be directed by others.
- i. A workers avoids taking decisions.
- j. Workers are normally passive, even resistant to organisational needs.

The assumptions regarding human nature that man is by nature lazy, lacks ambition, dislikes responsibility prefers to be led and that he is self-centred, indifferent to organisational goals, resistive to change are negative assumptions. In order to achieve objectives, therefore, the managers must adopt coercive attitude, close supervision and tight control. People can be motivated by monetary incentives and threat of punishment. Theory X is regarded as the means to supervise and control the workers.

**18.7.3 (ii) Theory Y Assumptions:**

- a. The average human being does not inherently dislike work. Human being has tendency to work.
- b. Work may be a source of satisfaction to the employee.
- c. Workers extend full co-operation for job completion.
- d. Workers has self-direction, self-motivation, self-discipline and self control.
- e. Workers are ready to accept extra responsibility.
- f. Workers has competence to work and can take right decisions.
- g. A work may exhibit his efficiency even for non monetary rewards.



Theory Y thus assumes that people by nature are not lazy and unreliable. They enjoy work, are ambitious and want to do work. They have potentials for development, capacity for assuming responsibility and will do work. People are motivated by self-control and self-development. This theory is based on optimistic and dynamic nature of human behaviour.

From the above, one can easily understand that superior should definitely be an autocratic manager to motivate the subordinates, in an autocratic manner as the mission of the management is achievement of organisational goals.

**Table 18.3**

**Comparison between Theory X and Theory Y**

<b>Theory X</b>	<b>Theory Y</b>
1. Inherent dislike for work	1. Work is natural like rest or play.
2. Unambitious and prefer to be directed by others	2. Ambitious and capable of directing their own behaviour.
3. Avoid responsibility	3. Accept and seek responsibility under proper conditions.
4. Lack creativity and resist change	4. Creativity widely spread.
5. Focus on lower level needs to motivate workers.	5. Both lower level and higher order needs are sources of motivation
6. External control and close supervision required to achieve organisational objectives	6. Self-direction and self control are required to objectives.
7. Autocratic Leadership	7. Democratic Leadership
8. People lack self-motivation	8. People are self-motivated

**18.7.4 Theory Z: William Ouchi** developed theory z after making comparative study of Japanese and American management practices. It is an integrated model of motivation. Z type of organisations has three major features. They are

- a. **Mutual** trust between members of organisation reduces conflict and leads team work.
- b. **Subtlety** requires sensitivity towards others and it yields higher productivity.
- c. **Intimacy** implies concern, support and disciplined unselfishness.

#### **Criticism**

1. This theory based on Japanese management practices. This management may not be suitable to other organisations having different culture.

2. There is lack of empirical research to confirm the practical utility of this theory.
3. This theory does not provide guidelines as to at what point of time it may be applied in any organisation.
4. There may be some operational problems in implementing Theory Z.

**18.7.5 Mc Clelland's need for achievement theory:** This is another needs theory. He classified all human needs into three categories viz., need for power, need for affiliation, and need for achievement. His philosophy is that all these needs are of herculian importance to make the organised enterprise work well while saying that the need for achievement is of paramount significance.

**18.7.6 Adams Equity Theory:** There are two main variables in this theory i.e. inputs and outcomes. Inputs are the contributions which an individual perceives that he puts into his job. Outcomes are the rewards which the individual receives from the organisation and from his job.

Inputs and outcomes are thus important elements in the exchange relationship between the organisation and its members. When the individual feels that the outcomes he receives from the organisation are fair in terms of his inputs he is satisfied and motivated. The person compares his input outcome ratio with the input-output ratio of other members of his level or status in the organisation. He is likely to reduce/increase his input of effort to create equity.

Equity =  $\frac{\text{Persons outcomes}}{\text{persons inputs}} = \frac{\text{others outcomes}}{\text{others inputs}}$ .

The main postulates of the equity theory:

- (a) Perceived inequity creates tension in the individual.
- (b) The amount of tension is proportional to the magnitude of the inequity.
- (c) The tension created in the individual motivates him to reduce it.
- (d) The degree of motivation is proportional to the perceived inequity.

**18.7.7 Vroom's Expectancy Theory:** Victor H. Vroom is a psychologist. This theory is based on the belief that people will act to maximise their rewards. In this theory motivation is determined by

**a. Expectancy:** The belief that the effort will be rewarded.

**b. Valence:** The value attached to specific needs.

Expectancy can be separated into two types.

Expectancy 1 is the belief that effort will lead to performance. An individual can perform well if efforts are made.

Expectancy 2 is the belief that the performance will lead to rewards.

Valence the second factor of motivation, is the value based on a reward. It can be either positive or negative. The more positive the value the person will be highly motivated.

The more the negative value, the less likely a person will be motivated.

The above theory can be explained diagrammatically.

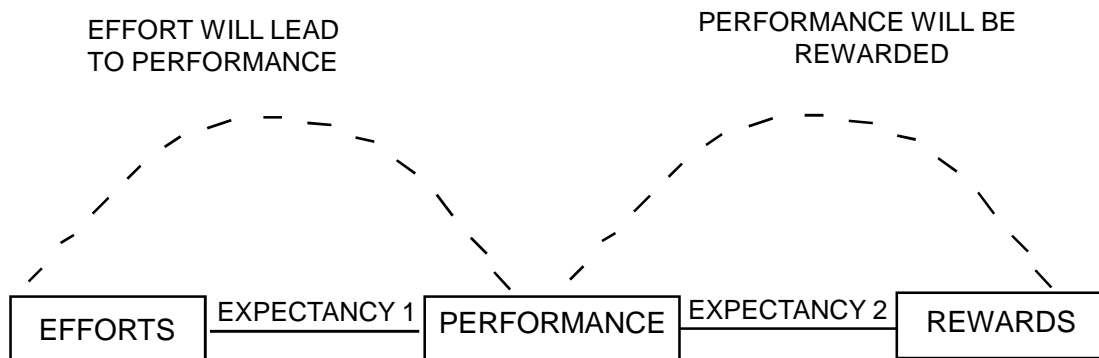

Fig. 18.6

### Merits

1. In case of expectancy 1, that the employees feel that the expected performance is attainable, by setting performance objectives.
2. In case of expectancy 2, that the desired performance is clearly linked with rewards cause high motivation.

In case of valence rewards are meaningful to employees, by understanding individual employee needs, managers can match them to rewards for maximum motivation.

### Criticism

Even though it is considered one better theories of motivation, it has certain its own limitations.

- a. Expectancy theory is very complex in nature.
- b. Practical application is difficult.
- c. Attempt to calculate expectancy 1. Expectancy 2 is doubtful.
- d. Valence estimates in making decisions are difficult.
- e. Complexity of expectancy theory also makes it difficult to test.

**18.7.8 Porter - Lawler - Expectancy Model:** This model is an improvement over the valence. Expectancy model. **Porter and Lawler** applied this model to the study of the behaviour of managers and concluded that there exists a complex relationship between job attitudes and job performance.

This theory tried to explore the relationship between motivation, satisfaction and performance. This can be explained through a diagram.

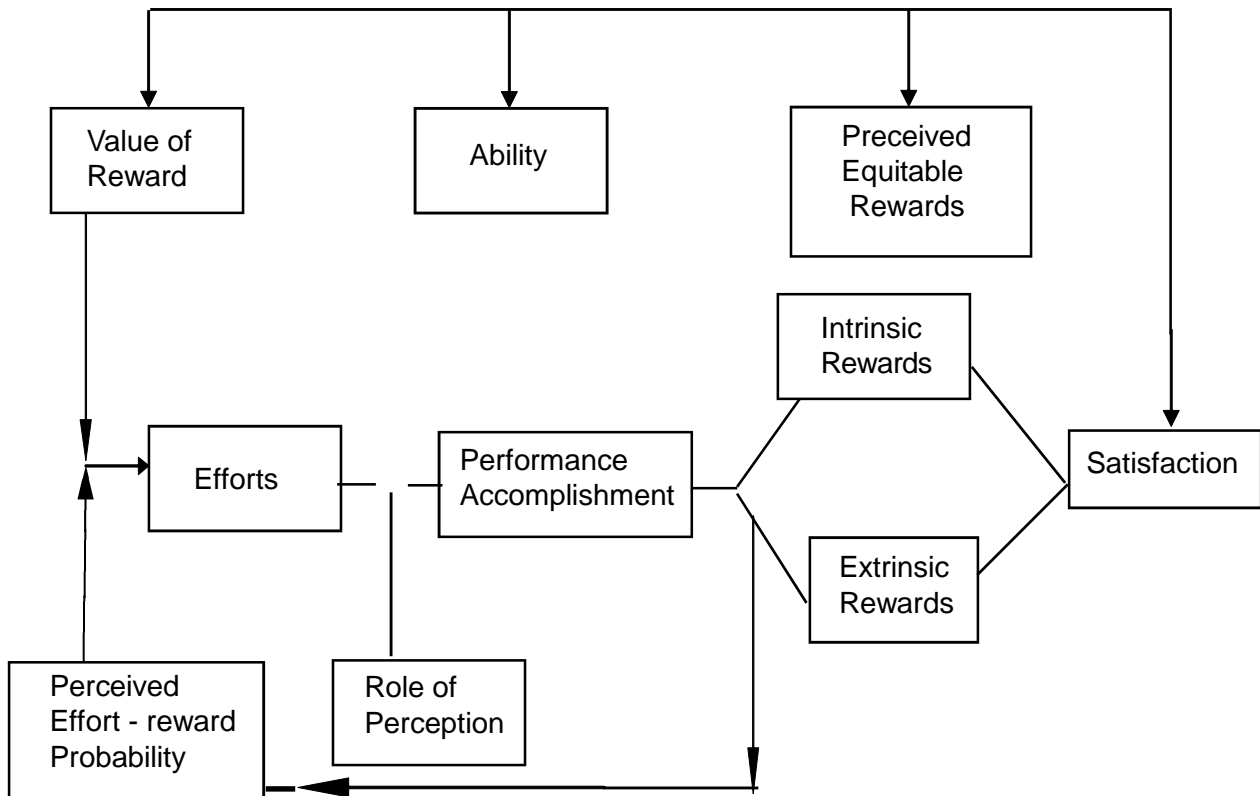

Fig 18.7 Porter and Lawler's Motivational Model

This theory pointed out that effort does not directly lead to performance, which is a function of three important factors.

1. One must be motivated if he is willing to perform the assigned task.
2. For this purpose he must have necessary skill and traits.

He must have an accurate knowledge of the job requirements.

**(i) Elements of Porter - Lawler Model:** Satisfaction and performance are separate variables.

Effort refers to amount of energy exerted by an individual on a given task.

Perceived-reward probability refers to the individuals perception of the probability that different rewards depend upon differential amount of effort.

Performance: Effort leads to performance but two are not equal.

Rewards are two kinds (i) Intrinsic rewards - such as a sense of self-actualisation and (ii) Extrinsic rewards. Such as working conditions and status.

Satisfaction is derived from the extent to which the actual award falls short or meets or exceeds the perceived reward.

**(ii) Implication of the theory:** Motivation is not a simple cause effect relationship rather is a complex phenomenon. Porter and Lawler suggested that managers should carefully assess their reward structure through careful planning and careful definition of role requirements, the effort performance - reward satisfaction system should be integrated into an overall system of managing.

**(iii) Elements of sound motivational system:** While adopting a motivational system. The following important considerations should be kept in mind.

**a. Adequateness:** The motivational system should be adequate covering the entire workforce in an organisation and it should cover all the activities of the employees.

**b. Flexibility:** The motivational system should be flexible enough to enable changes to be incorporated.

**c. Related to efforts:** The motivational system should be directly related to efforts. There should be positive interconnection between efforts and rewards.

**d. Analysis of motives:** A sound motivational system also analyses the factors which motivate the employees in the prevailing organisational environment.

**e. Simplicity:** The motivational system should be simple to be well understood by the employees as it is designed for them.

**f. Blending:** A sound motivational system should be a fine blending of the requirements of the employees, the objectives, and the philosophy of the organisation.

## 18.8 TYPES OF INCENTIVES

The needs of individuals are varied and different. Some of them can be satisfied by money, while others cannot be satisfied by money alone. On the basis of this, the incentives can be either in monetary or in non-monetary form.

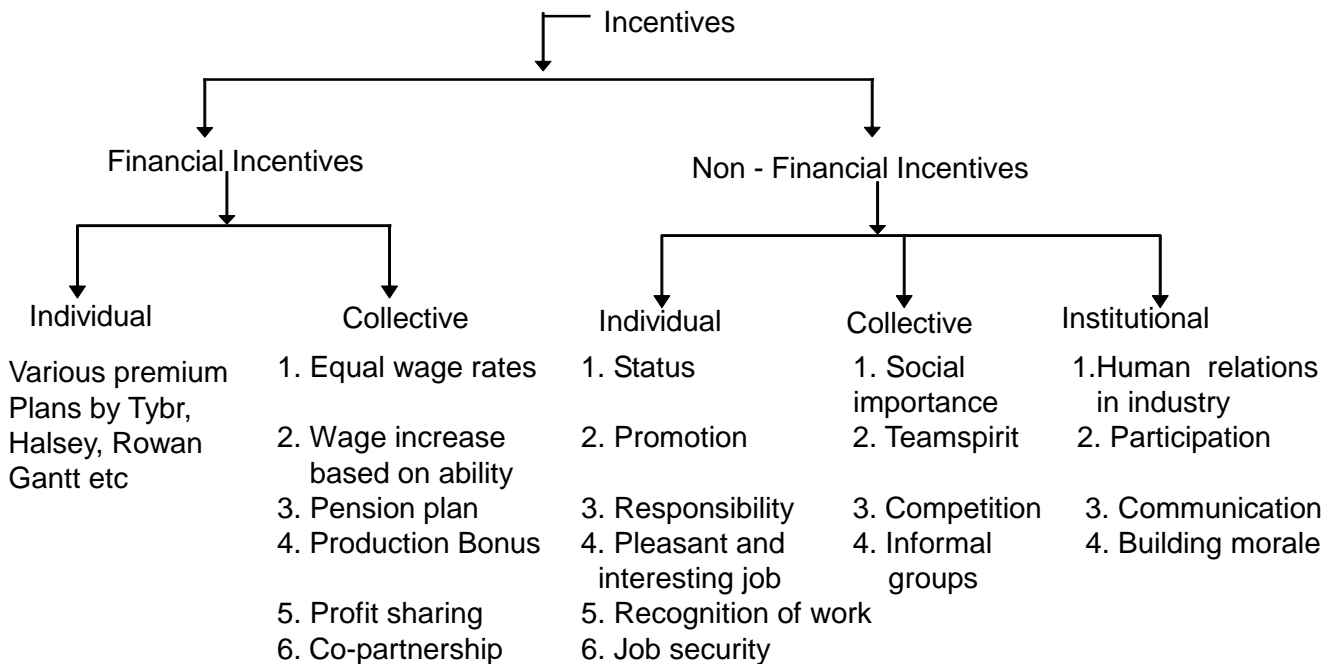

Fig. 18.8 Financial and Non-Financial Incentives

**(i) Monetary Incentives:** A monetary incentive is expressed in terms of money. It is very commonly used in modern organisation to motivate the employees to increase their productivity. It consists of wage payments, in excess of those paid to time rate workers, premiums, bonus, prizes and return on investments. Monetary incentives should have a relevance to the financial and social needs of the workers.

**(ii) Non-Monetary Incentives:** Non monetary incentives cannot be expressed in terms of money.

**(i) Individual Incentives:**

**(a) Status:** It is the ranking of positions, rights and duties in the organisation. Research indicated the fact that middle and higher level employees prefer escalations in status increments in pay.

**(b) Promotion:** It is the vertical movement of a person in the organisation. Promotion are accompanied by increased responsibilities, enhanced prestige and power, usually since promotions depend on good performance, most employees try to attain these if the organisation provides the opportunities.

**(c) Responsibility:** People want to handle responsible and challenging jobs. If the job is responsible, it satisfied people in more than one way.

**(d) Recognition of work:** Managers can motivate people by using this in the ways. Show appreciation when an individual does an outstanding job; compliment individuals in front of others; compliment individuals when the incident is still fresh in their mind. Recognition and appreciation will have a "tonic" effect on the psychology of employees.

**(e) Interesting work:** Jobs that are varied, pleasant and enjoyable motivate people thoroughly. Such jobs allow people to satisfy their natural instincts. Work in such cases becomes as natural as play a recreation and stimulates people to reach greater heights.

**(f) Job Security:** People want to secure jobs. They want to be aware about their future income and job continuity. For the same reason, people prefer government jobs to private jobs, where the security is good but not the income.

**(ii) Collective incentives**

**(i) Social importance of work:** People want jobs of high social status. They are prepared to accept such jobs, even when the pay is comparatively less. High status jobs enhance the social status of an individual in the society.

**(ii) Team Spirit:** People prefer to work in well-knit groups. Those organisations that encourage their employees to do the jobs in a cooperative manner, attract people automatically. When team spirit is encouraged among employees, they will put in their maximum in the service of the organisation.

**(iii) Healthy Competition:** Promoting healthy competition among employees through carefully chosen reward schemes spurs people to work harder.

**(iii) Institutional Incentives:**

**(a) Participation:** People prefer organisations that offer them good opportunities to participate in the decision making process. Participation enables people to offer valuable suggestions and concrete ideas and see that these are actually translated into action.

**(b) Sound Human Relations:** A positive work climate where people are treated as human beings is an important reward. It permits people to work with enthusiasm and spirit and contribute their best.

**(c) Morale:** Morale refers to the atmosphere created by the attitude of the members of an organisation. Poor morale is an organisational malady. The warning signals to be noted here are in the form of absenteeism, high turnover, strikes and sabotage, lack of pride in work etc.

**(d) Communication and Discipline:** Proper communication and good disciplinary procedures enables people to work with confidence and along the prescribed routes. The behaviour is consistent with goals and the changes of meeting the goals are high.

## 18.9 MORALE AND PERFORMANCE

Morale and job performance go hand in hand. The higher the morale the better the performance and vice-versa. The workers with high morale do not skip work, show good team spirit and contribute their best to the attainment of the organisational objectives. But thus is not always true. Increase in morale does not guarantee a proportionate increase in performance. It is quite possible to increase morale with either favourable or unfavourable shifts in performance as shown in the following figure.

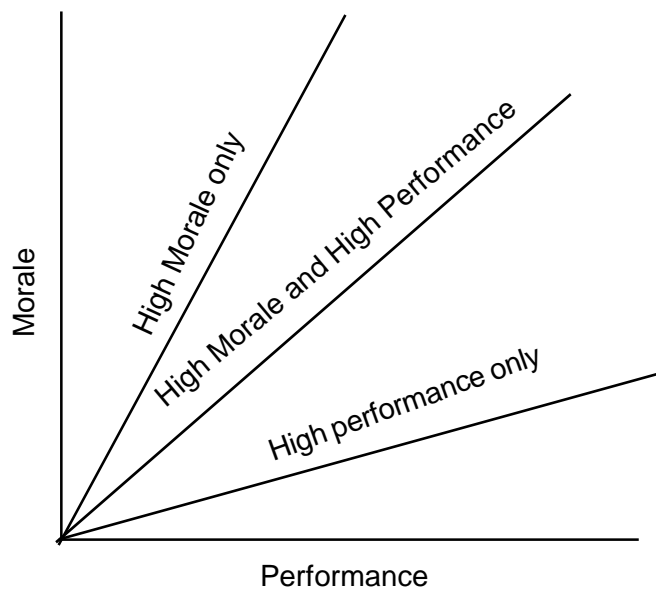

### 18.9.1 Morale and performance relationship

- (i) High morale and high performance
- (ii) High morale and low performance
- (iii) Low morale and low performance and
- (iv) Low morale and high performance

In the final analysis, a manager has to work for improving the morale of his employees. High morale makes the work more pleasant and will go a long way in improving the work climate. It helps the work group to attain goals easily, smoothly and more importantly, in a highly cooperative manager.

## 18.10 SUMMARY

Motivation is the process of stimulating people to adopt the desired course of action by satisfying their motives. Motivation influence others to work so as to gain reward and accomplish a given task. it is the motive, the needs drive, desires and aspirations and the attainment of objectives which inspire the working force to do their best. This inspiration is caused by the action of motivation. The result of motivation are such which go along way to pull and push the organisation towards the pre-determined goal. It is an effective instrument in the hands of management. It creates will to work. The team spirit is very much their because of motivation. It is helpful to increase the productivity and efficiency.

## 18.11 KEY WORDS

**Motivation:** Planned inducement to the working force offered by an organisation.

**Motivators:** Motivators are those who get sense of satisfaction.

**Directing:** Function of directing the people what to do and seeing that they do it to the best of their ability.

**Morale:** Capacity of a group people to pull together persistently and consistantly in persuit of a common purpose.

**Force:** Strength of persons motivation.

**Valence:** It is the strength of persons references for an outcome.

## 18.12 SELF ASSESSMENT QUESTIONS

1. What is motivation? Explain its significance in modern context.
2. Which are most widely accepted theories of motivation. Explain in detail.
3. Motivation is the core of management? Explain?
4. Compare and contrast the theories of motivation of Maslow and Herzberg.
5. Explain Mc Gregor's "Theory X and Theory Y".
6. Write short notes on
  - (a) Morale
  - (b) Incentives
  - (c) Theory X
  - (d) Vroom's Valence - expectancy theory of motivation
7. Distinguish between
  - (a) Motivation and morale
  - (b) Financial and non-financial incentives
  - (c) Morale and performance



### **18.13 FURTHER READINGS**

M. Motihar, Pawan Jaiswal - *Principles of Management*, Kalyani Publishers, New Delhi.

L.M. Prasad - *Principles of Management*, Sultan Chand & Sons, New Delhi.

Man Mohan Prasad - *Management Concepts and Practices*, Himalaya Publishing House, Mumbai & Delhi.

**- Dr. T. RAMA DEVI**

## **Lesson - 19**

# **COMMUNICATION**

### **19.0 OBJECTIVES**

After completing this lesson, you should be able to know

- \* meaning, definition and importance of communication
- \* characteristics of communication
- \* objectives of communication
- \* process of communication
- \* types of communication
- \* barriers to communication
- \* way to avoid barriers to communication
- \* characteristics of good communication system
- \* communication network

### **Structure**

- 19.1 Introduction**
- 19.2 Meaning and Definition**
- 19.3 Nature of Communication**
- 19.4 Objectives of Communication**
- 19.5 Process of Communication**
- 19.6 Importance of Communication**
- 19.7 Elements of Communication**
- 19.8 Forms of Communication**
- 19.9 Measuring effectiveness of Communication**
- 19.10 Barriers to Communication**
- 19.11 Impact of Barriers to Communication**
- 19.12 Way to avoid Barriers to Communication**
- 19.13 Building Effective Communication**
- 19.14 Communication Networks**
- 19.15 Summary**
- 19.16 Keywords**
- 19.17 Self-Assessment Questions**
- 19.18 Reference Books**

### **19.1 INTRODUCTION**

It is a managerial skill based on human behaviour and plays the same role in an organisation as the nervous system of the human body. It keeps the members of the organisation informed about internal and external happenings. Managers spend most of their working time in communicating with others. So we can say good managers are good communicators and poor managers are poor communicators.

## 19.2 MEANING AND DEFINITION

The word 'communication' has been derived from the Latin word 'COMMUNIS', which means 'COMMONS'. Communication, actually stands for the sharing of information, an idea or an attitude in common. Communication is a process of transmitting information from one person to another and a means by which organised activity is justified.

Communication is the transfer of information and understanding from one person to another. Thus, communication is an exchange of information between two or more persons, where information is defined as any sign, symbol or signal used by one person to achieve the desired effect in the behaviour of another person.

According to **Keith Davis** "Communication is the process of passing information and understanding from one person to another".

**Cyrin Hudson** says "Communication in its simplest form is a conveying of information from one person to another".

According to the **American Management Association** **Communication** is "any behaviour that results in an exchange of meaning".

According to **Charles Redfield**, "communication is the broad field of human interchange of facts and opinions and not the technologies of telephone, telegraph, radio and the like".

## 19.3 NATURE OF COMMUNICATION

**(i) It involves at least two persons:** Communication involves at least two persons, a sender and a receiver. The sender is called communication and the receiver of the message is known as communicatee. A person who speaks, writes or issues some instructions is the sender and the person for whom the communication is meant or who receives the message is the receiver or communicatee.

**(ii) There must be a message:** A message is the subject matter of communication, e.g the contents of letter or speech, order, instructions or the suggestions. A communication must convey some message.

**(iii) Message may be written or oral:** Communication is generally understood as spoken or written words. It includes everything that may be used to convey meanings from one person to another.

**(iv) It is a two way process:** It involves both information and understanding. Communication is not complete unless the receiver has understood the message properly and his reaction or response is known to the sender.

**(v) Primary purpose is to motivate a response:** The primary purpose of communication is to motivate a response or influence human behaviour.

**(vi) It may be formal or informal:** Formal communication follows the formal channels provided in the organisation structure. In formal communication, there is no direct communication between the managing director and the accounts clerks. Informal communication flows from informal channels of communication which are not provided in the organisation structure. Those channels develop among members because of personal contacts through working with each other.

**(vii) Flows top and down and also from side to side:** Communication flows downward from a superior to subordinates and upward from subordinate to a superior. It also flows between two or more persons operating at the same level of authority.

**(viii) An integrated part of the process of exchange:** It refers to the exchange of ideas, feelings, emotions, and knowledge and informations between two or more persons.

## 19.4 OBJECTIVES OF COMMUNICATION

**a. Sending the correct and right message:** Communication is meant for conveying the right message to the right person. The message conveyed should be well understood, accepted, and translated into practice as well.

**b. Co-ordination:** Communication serves as a tool to co-ordinate the efforts of all who are involved in running a business. Without communication co-ordination is a remote possibility.

**c. Healthy industrial relations:** Communication aims at healthy industrial relations.

**d. Development of managerial skills:** Communication is a learning process. Facts, informations, ideas etc., enriches the knowledge of the executive who tries to make use of the acquired knowledge which results into an increase in his wisdom and skill.

**e. Effectiveness of policies and programmes:** Policies and programmes of the enterprise need communication to those who are to execute them. Effectiveness of the policies can be judged from its success which depends on effective communication system.

**f. Boosting the morale:** Productivity goes up and the cost of production shows a declining trend if the communication is effective and workers have understood its letter and spirit.

## 19.5 PROCESS OF COMMUNICATION

Communication is a process, a concept of change rather than that of static existence. The various elements involved in this process are shown in the following figure.

Communication -- Message -- Encoding -- Channel -- Receiver -- Decoding



Feedback

Fig 9.1 The Communication Process

**(i) Communicator:** Is a person who conveys the message.

**(ii) Message:** The subject matter of the communication. Ex: It may be opinion, order, appeal, views, suggestions etc.

**(iii) Encoding:** Subject matter of the communication is abstract and intangible, its transmission requires the use of certain symbols (words, signs etc). The conversion of the subject - matter into these symbols is known as encoding.

**(iv) Channel:** The medium (radio, telephone, air etc) used to transmit the message is known as the communication channel.

**(v) Receiver:** Is a person for whom the message is meant.

**(vi) Decoding:** Decoding is the process by which the receiver converts the symbols received from the communicator to derive the meaning of message.

**(vii) Feedback:** Feedback is the reversal of the communication process in which a reaction to the communicators message is expressed.

## 19.6 IMPORTANCE OF COMMUNICATION

In the words of **Norbert Wiener**, "Communication is the cement that makes organisation". No organisation can think of its existence without effective communication. "The first executive function is to develop and maintain a system of communication". The importance of communication can, therefore, be judged from the following.

**1. Basis for decision making and planning:** Communication is highly essential for planning and decision making. It is an aid in the proper implementation of plans and policies of the management.

**2. Facilitates smooth working:** Communication makes possible the smooth working of an organisation. **Terry** states that "Communication serves as the lubricant, fostering the smooth operations of the management process".

**3. Facilitates coordination:** Modern large scale enterprises comprising a large number of workers can attain their goals only through coordination of various activities. But coordination can be achieved only through effective communication.

**4. Promotes Industrial Peace:** Effective communication promotes industrial peace as it helps develop understanding between the superiors and the subordinates.

**5. Facilitates control:** Communication helps the control process by transmitting information about the performance of the subordinates to the manager.

**6. Basis of Leadership:** Communication is the basis for establishing effective leadership as it helps in bringing the leader and the led in close contact with each other.

**7. Motivation:** Effective communication helps in motivating workers for accomplishing the organisational goals.

**8. Job Satisfaction:** Since effective communication creates mutual trust and confidence between the employer and employees, it gives a sense of job satisfaction.

**9. Public relations:** Effective communication promotes public relations as it helps the management to present a good corporate image to the outside world.

## 19.7 ELEMENTS OF COMMUNICATION

- a. **A communicator:** The person who speaks out a sends or transmitts a written message.
- b. **Transmission:** The act of saying, sending or issuing the message.
- c. **Message:** The information, order, appeal, observation, instruction report etc that is communicated.
- d. **The Receiver:** The receiver, addressee, respondent, or audience to whom the message is communicated.
- e. **Reply:** Response or reaction of the communicatee.

## 19.8 FORMS OF COMMUNICATION

Communication may be classified into several categories on the following basis.

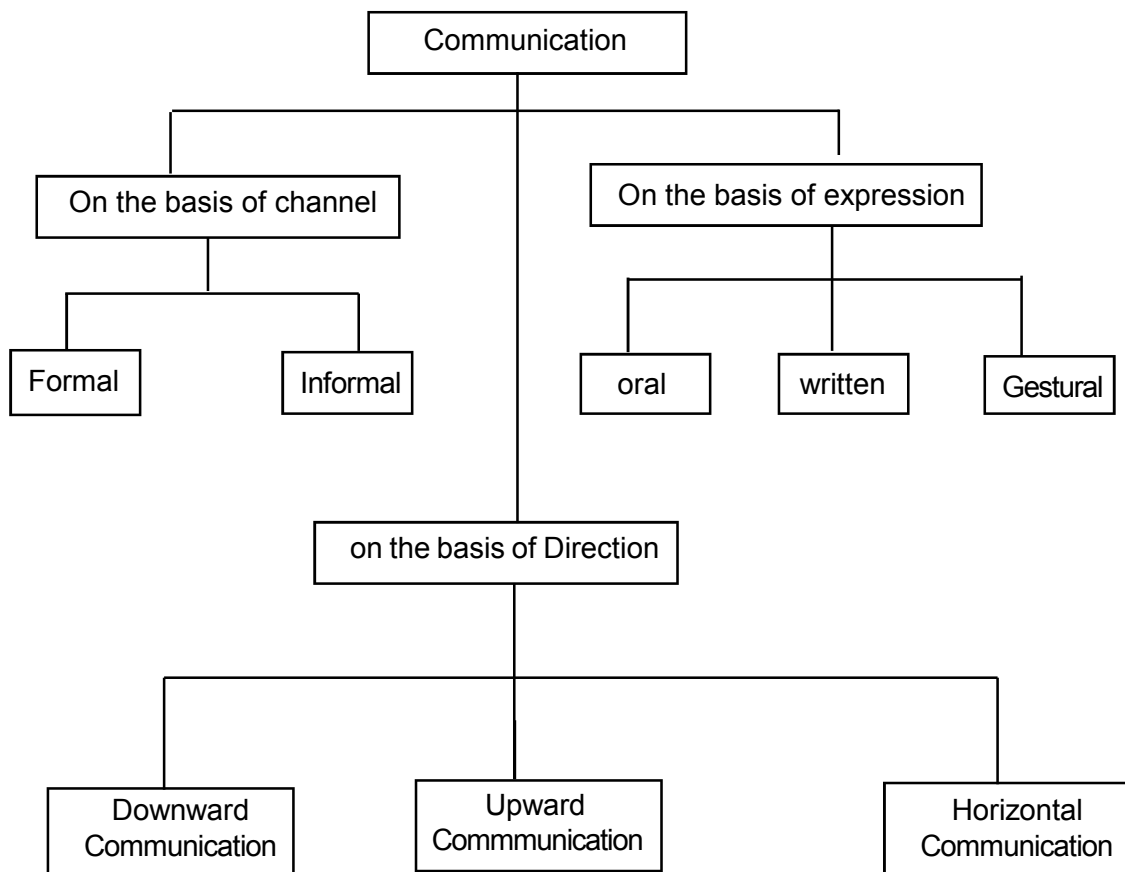

Fig: 19.2 Forms of Communication

**19.8.1 Channels of Communication:-** A channel of communication represents various linking points that exist between different departments or individuals in the enterprise. It is the path through which information is transmitted throughout the enterprise. It may be either formal or informal.

**19.8.2 Formal Communication:-** Formal communication is one which takes place in a formal organisation structure. It represents the flow of information along the lines of authority formally established in the organisation. It usually takes the form of written communication.

#### **Merits of formal communication**

- a. It helps in the fixation of responsibility.
- b. It helps in maintaining the authority relationship in the organisation.
- c. It ensures orderly flow of information.
- d. It facilitates control by supervisors by providing timely information.

#### **Demerits of formal communication**

- a. It is time consuming
- b. It obstructs free and uninterrupted flow of information
- c. It is usually conveyed in an impersonal manner.

**19.8.3 Informal Communication or Grapevine Communication:-** Informal communication is based on informal relationship between the two parties the sender and the receiver. Informal communication is also known as grapevine. It is the primary source of upward communication. It transmits information about what people are doing. It feels towards a particular situation or thinks about the management.

**Prof. Keith Davis** has identified four different network for transmitting information via the grapevine. They are

- (i) Single strand
- (ii) Gossip chain
- (iii) Probability chain
- (iv) Cluster chain

**(i) Single strand:** In the single strand, a person communicates with only one person.

**(ii) Gossip chain:** In Gossip chain, every member talks with every one else, usually about personal matter.

**(iii) Probability chain:** In this communication is random.

**(iv) Cluster chain:** In it messages are transmitted selectively. Grapevine generally operates like a cluster chain. For ex: If a person tells something to four or five persons, only one or two of them will pass on the information to more than one person. As the number grows larger and the information becomes older, it gradually dies out, because those who know it do not repeat it. This process is called cluster chain because each link in the chain tends to inform a cluster of other people instead of

only one person. In the cluster chain only a few persons are active communicators and such persons are known as liaison agents. The above mentioned network can be seen in the following figures.

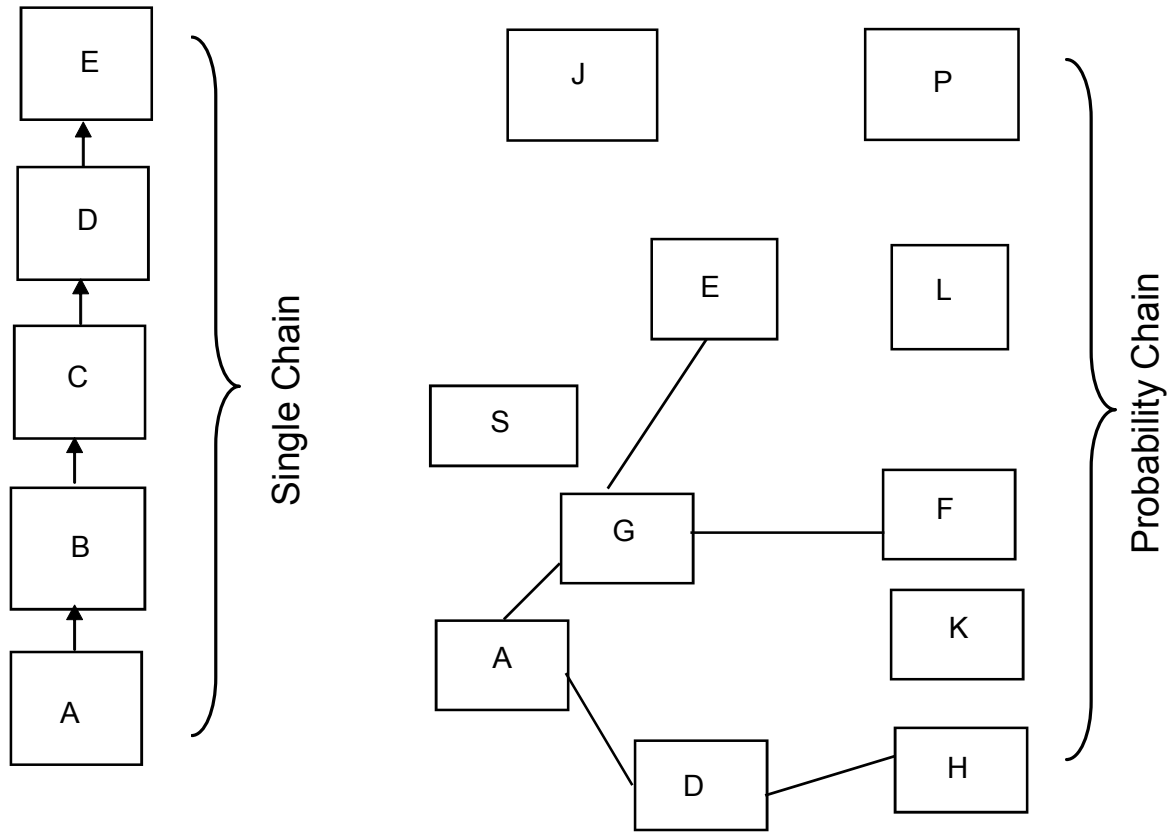

Fig. 19.3

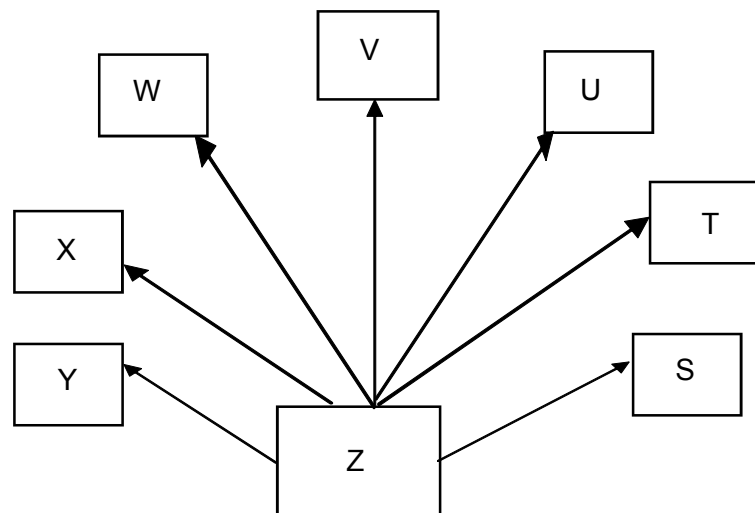

Fig. 19.4 Gossip Chain



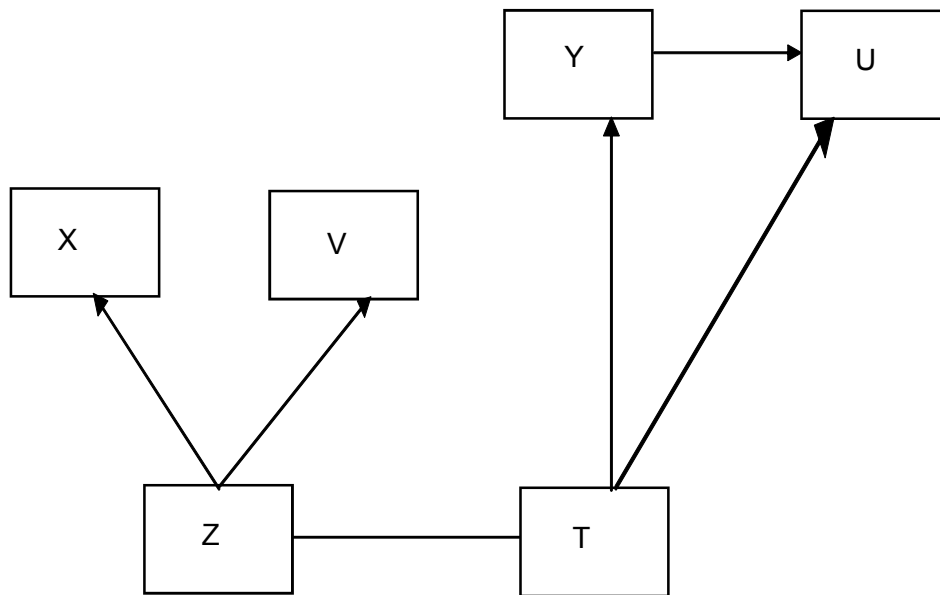

Fig. 19.5 Cluster Chain

**Merits of informal communication:**

- a. It helps to improve managerial decision making.
- b. It satisfies the desire of the people.
- c. It serves to fill the possible gaps in the formal communication.
- d. Its speed is very fast as it is free from all barriers.

**Demerits of informal information**

- a. It carries inaccurate information.
- b. It consists of facts, half truths, rumours and distorted information.
- c. The responsibility of its origin cannot be fixed.
- d. It leads to the leakage of confidential information.

**19.8.4 Communication on the basis of Direction:** On the basis of direction, communication is either vertical or horizontal. Vertical communication moves both downward and upwards. Horizontal communication takes place between two subordinates under the same superior or between two departmental managers.

**(i) Downward Communication:** Under this method, communication flows from the superiors to the subordinates, orders, instructions, circulars and manual are instances of this type of communication. Downward communication is best suited to the line organisation.

**(ii) Upward Communication:** Upward communication is the opposite of the downward communication. In it communication flows from the bottom of the organisation upward to the top of the organisation through middle managers along with the line. Reports, suggestions, complaints and grievances are instances of this type of communication.

**(iii) Lateral (Horizontal) Communication:** It refers to the flow of information between departments or people of equal level in an organisational structure. It may be written or oral. The two departments may be under the same superior or may have different heads. The main object of lateral communication is to co-ordinate the efforts of different departments or persons.

#### **19.8.5 Communication on the basis of expression:**

**(i) Oral Communication:** Transmission with the help of spoken words is oral communication. In it both parties of the process exchange their ideas through oral words either in face to face, situation or through any devices such as telephones, mobile or wireless. meetings, lectures, interviews, counselling, public address system, conferences are some other media of communication.

**(ii) Written communication:** When communication is transmitted into black and white, it is called written communication. This includes written words, graphs, diagrams, pictures, etc. A written communication becomes essential where oral communication is not possible either due to a large number of communicatees or due to wide geographical distances of the sender and receiver of the communications.

**(iii) Gestural Communication:** Communication through gestures or postures is known as gestural communication. It is often used to supplement the oral communication. It conveys feelings, emotions, and attitudes, reactions and responses. When a manager shakes hands with the subordinates a pat on his back, it conveys something important to subordinates.

### **19.9 MEASURING EFFECTIVENESS OF COMMUNICATION**

Effectiveness of communication can be evaluated by systematic approach in terms of stated objectives. Any assessment of communication, therefore, requires the determination and fixation of norms oriented to the basic objectives of the process itself. The effectiveness of communication can be assessed through the evaluation of the following elements.

\* **Clarity:** The message must be as clear as possible. No ambiguity should be creep into it.

\* **Adequacy:** The adequacy of communication should be understood in terms of both coverage and quantity of various types of messages. The adequacy of coverage can be measured through a communication audit.

\* **Timing:** The utility of any message to the receiver is dependent on its timeliness. Thus the communication should not only ensure that the message reaches the receiver but also ensure that it reaches on time.

\* **Integrity:** It should be as far as possible be based on the policy of integration of efforts in order to avoid confusion and achieve better understanding.

### **19.10 BARRIERS TO COMMUNICATION**

The barriers to communication in an organisation may be broadly categorized into

\* Physical Barriers

\* Personal or Socio-psychological Barriers

\* Organisational Barriers

\* Semantic Barriers

\* Mechanical Barriers

**19.10.1 Physical Barriers:** There are environmental factors that obstruct or reduce the sending and receiving of communication such as physical distance, distracting noises and other interferences. As the physical distance increases communication of message becomes difficult.

### **19.10.2 Personal or socio-psychological Barriers:**

**(i) Psychological distance:** Personal barriers are from motives, attitudes, judgements, emotions and social values of people. These may create psychological distance similar to physical distance.

**(ii) Individual differences:** Persons differ in their motives, attitudes or sentiments. Interpersonal perceptions or inter-personal emotions may cause breakdown because each perceives the thing in the light of his own experience, prejudices and thinking.

**(iii) Difference in Interest:** The interest of people differs and so is their attitude. The ideas, questions, attitudes, feelings etc., of other party may present an obstacle to one's own personal goal. In the absence of adequate self-confidence or for fear of retaliation are restrained the expression of his true feelings.

**(iv) Division of people:** Division of people into classes, castes and communities also affects communication of ideas and viewpoints.

**(v) Difference of view points:** View points may differ and so communication suffers. An executive may be harsh enough not to hear and accept others view point, whether right or wrong.

### **19.10.3 Organisational Barriers:**

**(i) Hierarchical distance:** The possibility of filtering the information is there when the manager decides to pass only a part of the information received from below or above. In this way he may deprive people at the bottom of the wishes of the executive at the top. Similarly it may keep the top executive in dark from the happenings at the lowest level.

**(ii) Diversion:** Sometimes a manager diverts the information meant for one person or group to another.

**(iii) Colouring:** The manager may colour the information, sometimes intentionally with view to twist the situation in his favour or sometimes out of situation.

**(iv) Status Barriers:** Status is a barrier of communication in a formal organisation. An executive in the middle of management hierarchy, may worry much about what his senior bosses are thinking and pay minimum attention to the thoughts of his juniors or subordinates. The subordinates are reluctant to communicate anything which their boss does not like. This may have negative effect on their relationship.

**(v) Poor Supervision:** When a superior suspects his subordinates or acts as a self-appointed censor or listens his subordinates with closed minds, the communication is blocked or when he thinks that his subordinates are less competent and capable, they do not advise superiors.

#### **19.10.4 Semantic Barriers:**

**(i) Inferences:** Inference may give a wrong signal, therefore one should be aware of them and appraise them carefully. More feedback should be sought in case of any doubt.

**(ii) Symbols:** Symbols may be classified as language, picture or action. Their effect as barriers is immense.

**(iii) Language:** In verbal as well as in nonverbal communication words are the principle communication instrument of all employees. Most of the time of managers and other executives is spent in verbal communication. In a face to face verbal communication, a clarification may be sought if doubts exist about a particular word. But it is difficult in non verbal communication. Consequently, effective communication are idea centred rather than word-centred.

**(iv) Picture:** Sometimes a picture may create confusion in the mind of an observer. This can be done away if pictures are supplemented with well chosen words and actions to tell the whole story.

**(v) Action:** Whatever we do or not do it is an action and effective means of communication to the extent it is interpreted by others. To do or not to do both have meaning.

**(vi) Body Language:** Body language supplements to nonverbal communication. In interpersonal interaction people communicate meanings to others with their bodies. Body language means communicating the message with the movement of the whole body or a part of it.

**19.10.5 Mechanical Barriers:** Mechanical Barriers include inadequate arrangement for transmission of news, facts and figures. Poor office layouts, defective procedures and practices and the use of wrong media lead to poor communication.

### **19.11 IMPACT OF BARRIERS TO COMMUNICATION**

The above barriers in effective communication of message vitiate the message in several ways such as -

- \* **Distortion of message:** It means changing the context of the message or the meaning of the message.
- \* **Filtering:** It means reducing the message only to a few basic details.
- \* **Omission:** It represents deletion of all or part of the message.

### **19.12 WAYS TO AVOID BARRIERS TO COMMUNICATION**

Following ways are recommended to minimise the chances of distortion of communication.

- \* **Clarity of information:** The language used in communication should be clear, precise and simple so that people at all levels realise the full significance of communication.

\* **Prompt Action:** Information should be passed promptly to every one concerned so as to avoid delay in action.

\* **Creation of proper atmosphere:** The management should take all necessary steps to create a peaceful atmosphere in the organisation so as to facilitate effective communication of instructions and suggestions.

\* **Development of interpersonal relationships:** As communication is an interpersonal process. The development of interpersonal relationships based on mutual respect, trust and confidence is essential for its promotion.

\* **Effective channels:** There will be no room for rumours, lies, guesses and misconceptions, if the communication channel is well defined.

\* **Feedback:** Communication should be a two-way traffic. There should be some system by which the workers should be able to convey their suggestions and grievances to the top management.

### **19.13 BUILDING EFFECTIVE COMMUNICATION**

The **American Management Association** has suggested the following ten commandments of good communication.

- \* Clarifying an idea before communication
- \* The purpose of communication
- \* Understanding the physical and human environment of communication
- \* Consulting others in planning communication
- \* Contents and overtones of communication
- \* Value of communication to the receiver
- \* Follow-up action
- \* Importance of communication
- \* Action congruent with communication
- \* Good listening

### **19.14 COMMUNICATION NETWORKS**

Communication network is a pattern of inter-connected lines. It is the system where the message may flow in one direction or in several directions. As a pattern of contacts among the members of an organisation, communication network contains channels. If the network is too long or round about there will be delay in the flow of communication. If it is too narrow the message may get blocked. when the network contains several filtering points the message may get distorted. there are four main communication networks as shown in the following figure.

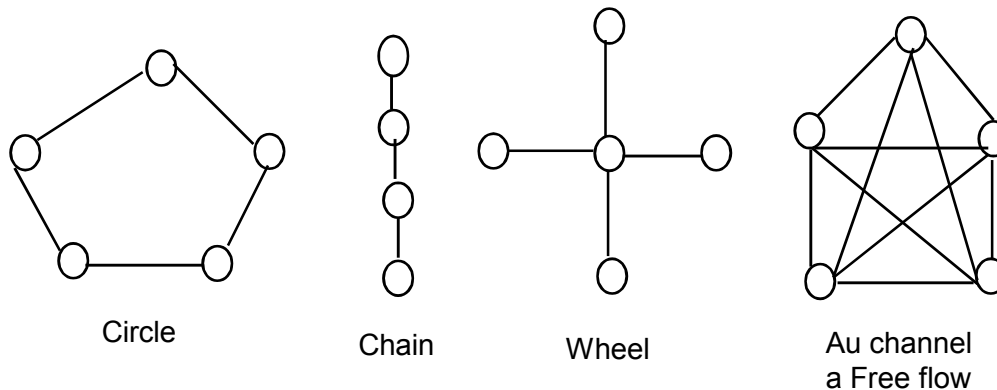

Fig. 19.6 Communication Networks

**(i) Circle Network:** In case of circle network, the message moves in a circle, under it each person can communicate with two others located on both of sides.

**(ii) Chain Network:** Under this message flows in a direct vertical line along the scalar chain of command. All the subordinates receive order and instructions from one superior.

**(iii) Wheel Network:** In this a number of subordinates report to one superior. It is called wheel because all communications pass through the centre person similar to the hub of a wheel.

**(iv) All channel Network:** It represents free flow of communication. Every member is allowed to communicate freely with all other members. It provides highest satisfaction.

## 19.15 SUMMARY

Communication is an exchange of written or verbal information aiming at influencing the thinking, ideas and behaviour of those with whom one is working as a team. For an effective communication first the messages are prepared, then they are sent, after then they are received. The communications are to be channelised and codes should be prepared for better results. Efficiency and effectiveness of management depends upon effectiveness of communication. There is no management when there is no proper communication.

## 19.16 KEY WORDS

**Communication:** Simplest form of conveying of information from one person to another.

**Horizontal Communication:** Communication between people of equal status.

**Formal Communication:** Communication passed through effectively recognised positions in the organisation chart.

**Grapevine Communication:** It is an informal communication. It deals about a particular situation or thinks about the management.

**Barriers to Communication:** Several causes for the ineffectiveness of communication.

### **19.17 SELF - ASSESSMENT QUESTIONS**

1. What do you mean by the process of communication? What are the various stages included in it?
2. Narrate some of the important barriers to effective communication. Suggest measures for overcoming such barriers.
3. 'Good communication is the foundation of sound management.' Elucidate.
4. Explain the methods of communication in detail?
5. What are essential elements of effective communication? Discuss its importance in business management.

### **19.18 REFERENCE BOOKS**

- \* M. Molihar: Pawan Jaiswal. Principles of Management, Kalyani Publishers, New Delhi.
- \* C.B. Gupta: Management Theory and practice, Sultan Chand & Sons, New Delhi.
- \* V.S.P. Rao and V. Hari Krishna: management Text & Cases, Excell Publishers, New Delhi.
- \* L.M. Prasad: Management Principles and practices., Sultan Chand & Sons, New Delhi.

**- Dr. T. RAMA DEVI**

## Lesson - 20

# CONTROLLING

### 20.0 OBJECTIVES

The objectives of this lesson are you are able to know -

- \* the concept of Controlling
- \* the process of Controlling
- \* essentials of Effective Controlling
- \* management by exception

### Structure

- 20.1 Introduction
- 20.2 Meaning of Controlling
- 20.3 Characteristics of Controlling
- 20.4 Nature of Controlling
- 20.5 Process of Controlling
- 20.6 Importance of Controlling
- 20.7 Requisites of a good Controlling System
- 20.8 Supervision
- 20.9 Types of Supervision
- 20.10 Management by Exception
- 20.11 Summary
- 20.12 Key Words
- 20.13 Self - Assessment Questions
- 20.14 Reference Books

### 20.1 INTRODUCTION

Controlling is the last managerial function. It is one of the two inseparable functions in management being Planning and Controlling. These two functions are inseparable as planning doesn't meet its purpose without controlling, while controlling can't achieve its goal without the assistance of planning and its components. So very significant managerial function is 'controlling' though it is the last one.

- \* It is making a review
- \* It is an investigation and audit
- \* It is looking back once to checkup
- \* It is making a comparison between two important aspects viz. actuals and standards, to find out whether the actuals are at variance with standards (or) not.

### 20.2 MEANING OF CONTROLLING

The executives instrument panel which guides progressive business to its target is managerial control. The purpose of the control function is to examine the past and present activities so as to search out weaknesses which can be eliminated in the future and to ascertain the results.



In the words of **Koontz and O'Donnell** "Control is the measurement and correction of the performance of subordinates in order to make sure that enterprise objectives and the plans devised to attain them are accomplished".

### 20.3 CHARACTERISTICS OF CONTROLLING

The main characteristics of the controlling function are -

**(a) Controlling is a self corrective process:** Controlling begins with planning. It can be exercised only with reference to and on the basis of plans which establish the objectives. Actual performance is compared with the objectives established and deviations measured.

**(b) Controlling exercises at all levels:** Controlling is exercised at all levels of management i.e. top level, middle level and lower level.

**(c) Controlling is a continuous process:** In the process of comparison of standards with actuals there will be a constant analysis of the validity of objectives, policies, procedures, positions, incentives and reports etc.

**(d) Controlling is forward looking:** Another characteristic feature of controlling is that it always looks forward. It relates to the future as a manager has no control on the happenings in the past. They can only correct future action for further operations of work. Managers find it easy to reduce wastage, loss and deviation from standards in future from the knowledge which they have attained from previous experiences.

**(e) Controlling is a dynamic process:** It is dynamic and flexible. It requires regular review and check up of standards and performances which leads to proper corrective action in plans according to the changing atmosphere, tests and needs of business.

**(f) Controlling is closely related to planing:** Control makes impossible things possible which would not otherwise happen. For this certain objectives are framed and are returned to as standards against which actual performance is checked.

Thus, although control is last function of the management, it is not least and enables again planning function.

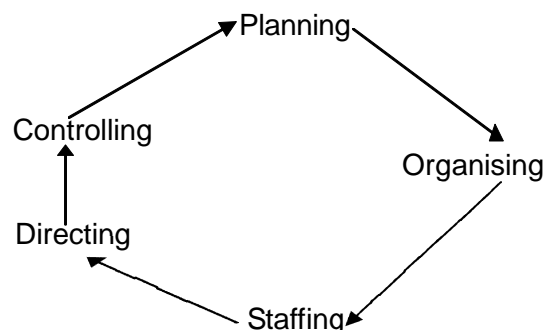

## 20.4 NATURE OF CONTROLLING

nature of controlling function can be expanded in the following way.

### 1. Planning is the basis of control:

Control can be exercised only on the basis of plans. Effective control is possible only with the clear and effective planning of the organisation. Planning sets the course of action and control observes deviations from the course of action.

### 2. Action is the essence of control:

Control is to correct a condition which is different from the one that is desired. To control, manager has to initiate action which will guide the operations within the sphere of plans.

For instance 'Thermostat in a refrigerator works as the essence of control'.

### 3. Delegation is the key to control:

Control is exercised by taking action and action may be taken within the authority delegated. An executive can perform the control function only if he enjoys the authority to take remedial action and is to be held accountable for results.

#### Example:

Suppose an executive is given the responsibility for maintaining the production level. He can really be held accountable for this responsibility only if he has the authority to get the materials, equipment and take the action against reward the more efficient.

### 4. Information is the guide to control:

Control is exercised by a manager on the basis of the information and reports from those actually doing the job. Such information and reports may be called the feed-back from the operations. Feed back enables the manager to determine how far the operations are proceeding in conformity with plans and standards and where remedial action is called for accurate, adequate and timely feed back information helps the management to take decisions in time. Too much information is as bad as too little.

## 20.5 PROCESS OF CONTROLLING

Planning and controlling go together. These two are reciprocally related. Control seeks to compel events to conform to plans. It is performed in the context of planning and aids planning in two ways such as

- (a) it draws attention to situations where new planning is needed.
- (b) it provides some of the data upon which plans can be based.

Controlling is a step by step process. This process consists of the following steps.

**(1) Establishment of Control Standards:** Every function in the organisation begins with plans which are goals, objectives, or targets to be achieved. In the light of these, standards are established

which are criteria against which actual results are measured. For setting standards for control purposes, it is important to identify clearly and precisely the results which are desired. Standards must be set and stated in tangible terms, such as in terms of output of goods, costs, profit, time, staff etc. Standards can be set for many intangible items such as advertisement campaign, employee morale etc.

**(2) Measurement of Performance:** The second major step in control process is the measurement of performance. The step involves measuring the performance in respect of a work in terms of control standards. The presence of standards implies a corresponding ability to observe and comprehend the nature of existing conditions and to ascertain the degree of control being achieved.

The measurement of performance against standards should be on a future basis, so that deviations may be detected in advance of their actual occurrence and avoided by appropriate actions. Appraisal of actual or expected performance becomes an easy task, if standards are properly determined.

According to **Peter F. Drucker**, it is very much desirable to have clear and common measurements in all key areas of business. It is not necessary that measurements are rigidly quantitative. In his opinion, for measuring tangible and intangible performance, measurement must be -

- a. clear, simple and rational
- b. relevant
- c. direct attention and efforts
- d. reliable, self announcing and understandable complicated interpretation or philosophical discussions.

**(3) Comparing actual and standard performance:**

The third major step in control process is the comparison of actual and standard performance. It involves two steps -

- i. finding out the extent of deviations and
- ii. identifying the causes of such deviations.

When adequate standards are developed and actual performance is measured accurately, any variation will be clearly revealed. Management may have information relating to work performance, data, charts, graphs and written reports, besides personal observation to keep itself informed about performance in different segments of the organisation. Such performance is compared with the standard one to find out whether the various segments and individuals of the organisation are progressing in the right direction.

When the standards are achieved, no further managerial action is necessary and control process is complete. However, standards may not be achieved in all cases and the extent of variations may differ from case to case. Such variations depend upon the type of activity.

When the deviation between standard and actual performance is beyond the prescribed limit, an analysis is made of the causes of such deviations. For controlling and planning purposes, ascertaining the causes of variations along with computation of variations is important because such analysis helps management in taking up proper control action. The analysis will pinpoint the

causes which are controllable by the person responsible. In such a case, person concerned will take necessary corrective action. However, if the variation is caused by uncontrollable factors, the person concerned cannot be held responsible and he cannot take any action.

**4. Correction of deviations:** This is the last step in the control process which requires that actions should be taken to maintain the desired degree of control in the system or operation. Some actions are required to maintain the control.

Such control action may be -

- i) review of plans and goals and change therein on the basis of such review.
- ii) change in the assignment of tasks
- iii) change in existing techniques of direction
- iv) change in organisation structure
- v) provision of new facilities etc.

In fact, correction of deviation is the step in management control process which may involve either all or some of the managerial functions. Following this, decisions have to be taken for the future period.

Briefly, the process is described best by the following figure.

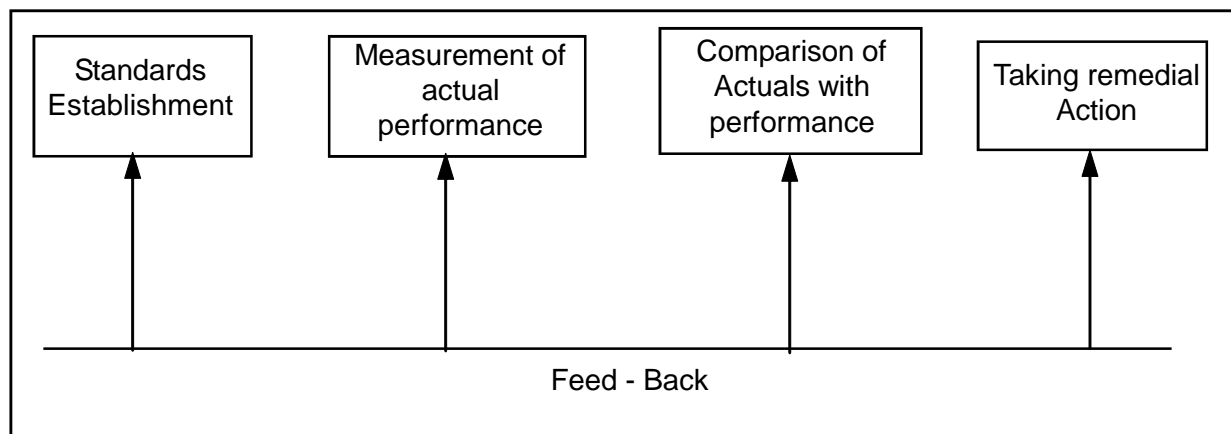

Fig. 20.1 : Controlling Process

## 20.6 IMPORTANCE OF CONTROLLING

The main objective of control is to ensure a high degree of efficiency of the business. this very objective helps the manager to attain the goals of the organisation in a systematic and effective way. The following are the uses of controlling technique.

1. Control helps to review operations and ensures high efficiency of the business.
2. Control appraise results against performance, standards and policies.
3. It helps to understand what had happened or is happening, why and by whom it happens.
4. It helps to ensure effective and proper communication between the management and workers

at all levels to achieve the objectives of the organisation.

5. Control is essential to keep a proper check and control over direct and indirect expenses.
6. Control helps to reframe organisational goals, policies and objectives.
7. Control helps the management to find out the various deviations from the planned and proposed targets and to take necessary corrective action.
8. Control is essential to make sure that all the activities are performed according to the pre-determined plans.

## 20.7 REQUISITES OF A GOOD CONTROLLING SYSTEM

1. **Suitability:** The system should conform to the nature and needs of the activity or position sought to be controlled.
2. **Prompt Reporting:** A good controlling system should be so devised as to report deviations from the plans and targets without loss of valuable time.
3. **Forward looking:** A proper system of control should take into account the possibilities of the recurrence of deviations from standards and should enable the manager concerned to think of and plan for future also.
4. **Focus on strategic points:** A good control system is not only points out the deviations or exceptions but also pinpoints where they are important to this operations.
5. **Flexible:** A sound control system should be flexible according to changes in plans.
6. **Objective:** Control should be definite, determinable and verifiable.
7. **Reflection of organisation pattern:** In enforcing control, the efficiency and the effectiveness of the organisation must be clearly brought out.
8. **Economical:** A control system must be economical in the sense that the cost of its installation and maintenance should be justified by its benefits.
9. **Understandable:** A control system should be easy to understand and follow by the managers.
10. **Suggestive of remedial action:** An effective system should disclose where failures are occurring, who is responsible for them and what should be done about them.

## 20.8 SUPERVISION

Supervision is the function of keeping a watch on the working and performance of the workers. It is ultimate step of directing function. Literally it means the act of overseeing. (super : above or over, vision, sight, seeing) Supervisor supervises the subordinates at work to ensure maximum utilisation of resources, to get the required and directed work done and to correct the subordinates whenever they go wrong. the major responsibility for supervision lies with the first line of management. Following aspects makes the supervision effective.

- \* Sound organisation setup
- \* Effective Delegation
- \* Human Approach
- \* Effective Communication

### \* Management by Exception

The function of supervision has two broad aspects to it.

- a. technical guidance and direction
- b. human relations and leadership

Supervision is to be done at all levels of management. The top management supervises the work of middle management and the middle level management has to supervise the work of lower level management. The first line supervisors observe the work performance of the operating people with whom they come into face to face contact.

**Characteristics of Supervision:** The main characteristics of a supervisor's job, i.e. supervision are:

1. He is the executive head of some workers who actually perform i.e. operative workers.
2. He works in close proximity of the actual performance.
3. He plans operations for a very short period - a day or two or a week at the most.
4. He instructs the workers at the actual work site.
5. He operates in close proximity of the workers.
6. He knows every individual worker's ability personally and can report on their performance.

## 20.9 TYPES OF SUPERVISION

Supervision is two types:

- (1) Direct supervision
- (2) Indirect supervision

**Direct Supervision:** Direct supervision is the function of assuring that the work is being done in accordance with the plan and instruction. This involves intelligent watch and check of the work while it is in progress, to ensure that the instructions are understood properly and that the individual is really doing it as desired. It is the function of first line (bottom) management. Direct supervision has the following merits.

- \* Direct supervision boosts the morale of employees.
- \* It increases their loyalty
- \* It provides immediate feedback on the work of subordinates.

**Indirect Supervision:** Managers at top level and middle level also watch work of bottom level with sudden visits, periodically. Top level and middle level managers direct the organisation by passing rules, objectives programmes even to first line supervisors.

## 20.10 MANAGEMENT BY EXCEPTION (MBE)

The principle of Management By Exception was first expressed as early as in 1919 by **Frederick W. Taylor**. Management by Exception means that "every body is given a target to be achieved and management need not supervise each and every thing". At higher levels of

management. Scientific Management consists in introducing this principle of management by exception. The main object of the principle is instead of overburdening the managers with all kinds of details about routine matters, only condensed reports must be sent to them. The routine matter and details must be gone into by assistants and others at lower levels. This will give the managers ample opportunity to deal effectively with important policy matters which deserve thorough and complete consideration at their hands.

**Objectives of MBE:**

1. To make the management concentrate on significant and difficult things.
2. Major deviations (standards - actuals) should be brought up for the managers attention.
3. Non deviations from standards should not be brought to his notice.
4. Fixation of targets of different individuals in the management.
5. To enable management thorough consideration of objectives of management.

**Benefits of MBE:**

1. With the use of standard costing, the targets of different individuals are fixed.
2. The attention of management is drawn only when actual performance is less than the budgeted performance.
3. No need of supervision of each and every thing.
4. Every body tries to achieve his targets.
5. Since things are going as per targets, management need not bother about each and every thing.
6. Management can devote its time to other important things.

**20.11 KEY WORDS**

Forward looking - Planning for future

**20.12 SELF ASSESSMENT QUESTIONS**

1. What is controlling? Discuss its nature.
2. What are requisities of a good controlling system.
3. Explain the process of controlling
4. Describe the concept management by exception.

**20.13 REFERENCE BOOKS**

Management	-	Koontz & O' Donnell
Principles of Management	-	P.C.Tripathi & P.N. Reddy
Principles and Practice of Management	-	L.M. Prasad

**Dr. K.Kanaka Durga**  
**Reader in commerce,**  
**Hindu College, Guntur**