

**PERSPECTIVE OF  
MANAGEMENT  
(DEMB1)  
(MBA 2 YEARS)**



**ACHARYA NAGARJUNA UNIVERSITY**

**CENTRE FOR DISTANCE EDUCATION**

**NAGARJUNA NAGAR,**

**GUNTUR**

**ANDHRA PRADESH**

**Lesson - 1****INTRODUCTION TO MANAGEMENT****OBJECTIVES:**

The objectives of this lesson are to :

- know the concept and meaning of management.
- understand the nature and significance of management.
- develop overall perception towards professional management.

**STRUCTURE :**

- 1.1 Introduction
- 1.2 Definitions and Meaning of Management
- 1.3 Nature and Features of Management.
- 1.4 Significance of Management.
- 1.5 Management Vs. Administration.
- 1.6 Management - Science or Art.
- 1.7 Management as Profession.
- 1.8 Managerial Skills
- 1.9 Universality of Management.
- 1.10 Summary
- 1.11. Key words
- 1.12. Self Assessment Questions
- 1.13 Further Readings

**I.1. INTRODUCTION :**

Modern business organisations are large, highly complex and innovative, hence they called for high quality management for their successful and long term existence, Shrewed managers bring optimum results to the organisations. Peter F. Drucker aptly quotes “Management is a specific economic organ of an enterprise”.

Eventhough, management as a subject of study is of recent origin, it is as old as human civilization. Because eversince people have started forming into groups, they have been practising some or other principles of management to coordinate group efforts. Management deals with individuals and groups in the organisation to achieve the objectives. Management is the process by which managers create, direct and operate purposive organisation through systematically co-ordinated, co-operative ‘human effort’. It means managers achieve the objectives through successful operation and performance of groups working together in the organisations.



In the recent times, management as a discipline has attracted the attention of both academicians and practitioners. The basic reason behind this development is the growing importance of management in every walk of life, along with the growth of large scale organisations where the coordination of human efforts has become inevitable.

In common parlance, the word management is referred by many people in various ways. Some people consider it as simply to command others. Several others regarded it as merely checking the clerical work and putting signatures wherever it is necessary. Trade unionists may look at it as an exploiting set of people. To many people, management means attending the meetings and passing the resolutions. In fact, the meaning of management lies in the name itself.

**M**  
**A** - **the Manager**  
**N**  
**A**  
**G** - **knowledge**  
**E**  
**M**  
**E** - **the people**  
**N**  
**T** - **Technology**

In the above, Man refers to the manager who leads the groups and organisation and is responsible for the performance of others activities. Fundamentally, it is necessary to distinguish managers and owners. Owners are those who invest capital in the enterprise and bear pertinent risks. Where as, managers are paid people responsible for others and the activities of answerable for the achievement of objectives of the organisation. Here Age does not mean chronological age, it refers to the knowledge to be possessed by a manager to operate the organisation successfully. Knowledge can be secured through experience, study and exposure. The word Men stands for the term people, i.e., the team of subordinates working under the supervision and control of the manager. Managers never work in a vacuum, they work with people. They achieve the objectives with the assistance of subordinates. T denotes technology, it means know-how. Managers should also possess skills, techniques and tactics to win the game and to achieve the objectives.

## **1-2. DEFINITIONS AND MEANING OF MANAGEMENT :**

Management is defined by different authors in various ways. There is not precise definition on management bringing all its features together because by nature, the subject is multi-disciplinary, dynamic, relative and ever expanding. In order to understand the management, the following definitions may be observed.

**Mary Parker Follert** describes "Management is the art of getting things done through and with the people".

**Wehrich and koontz** define, "Management is the process of designing and maintaining an environment in which individuals, working together in group efficiently accomplish preselected aims".

**Mc Farland** defines "Management as a process by which manager create, direct, maintain and operate purposive organisations through systematic, coordinated and cooperative human effort".

According to **Luther Gulick**, management includes planning, organising, staffing, directing, coordinating, reporting and budgeting ; often described as POSDCORB functions.

**Keith and Gubellini** state, "Management is the force that integrate man and physical plant into an effective operating unit".

**F.W. Taylor** writes , "Management is the art of knowing what you want to do in the best and cheapest way".

According to **Howard, M. Carlise**, Management is the process by which the elements of a group are integrated, coordinated and utilised so as to effectively and efficiently achieve organisational objectives.

**James A. Stoner** has given an operational definition to management, he states "Management is the process of planning, organising , leading and controlling the efforts of organisation members and of using all other organisational resources to achieved stated organisational goals".

From the analysis of the definitions mentioned above, it can be observed the management is the process of formulation of plans and objectives; securing man, material, machinery and money for the achievement of objectives; putting the resources into proper utilisation; directing the human resources to work and controlling the performance; and providing satisfaction to the owners, employees and society.

### **1.3. NATURE AND FEATURES OF MANAGEMENT:**

An analysis of the definitions cited above revaeals that each definition presents some aspects of management, hence, the summary of various characteristics of management can be mentioned as follows.

**(i) Management is a group activity :-** Management is esseitally the process of organising and implementing the group activity to secure the desired ends. Because no individual can achieve everything on his own, psychological and physiological limitations of people make them to unite together. So, whenever and wherever, there is an organsed group of people working towards a common objective, some form of management becomes necessary. Management makes the people to realise the objectives of group and directs them in a specified manner to achieve the stated goals.

**(ii) Management is objective -oriented :-** Basically orgainsations are formed to achieve the objectives. The objectives are agreede upon by the members of the group or the organisations. The organisational objectives are the desired state of affairs which the enterprise attempts to realise. Without objectives, it becomes

difficult to define the direction to where group activities lead to. Management enables and ensures the accomplishment of goals. because group activities in management are always directed towards the achievement of pre-selected objectives.

**(iii) Optimum utilisation of resources :-** Organisations make use of resources, like materials, money, machines, and men, to achieve the objectives. Managers apply their knowledge, principles and methods to utilise them optimally. Eventhough, people at the operative level directly deal with the resources, it is the responsibility of managers to their proper utilisation and integration.

**(iv) Decision - making :-** Managers are those people who make decisions throught the day. They make decisions ragarding the utilisation of resources, directions to the prople, determination of objectives and integration of activities etc., Decision making means the selection from among various alternative courses of action. Because, to perform any activity, there are alternative ways, managers should choose the proper way to get the optimal results. It involves the process of search for alternatives, evaluation of alternatives, selection of a course of action and implementation of the action. The quality of decision- making affects the performance of organisations, hence the success or failure of managers' activities depends upon the decisions they make.

**(v) Management is dynamic :-** It is a dynamic function and it is to be performed continuously in the organisations. Management is reciprocal to the changes in the environment, which are changing continuously from time to time. Some times, even managers cause certain changes in the environment by virtue of their decisions to ensure success to the enterprise, through introducing new products, changing policies and working conditions etc.,

**(vi) Management is a specific economic organ :-**

**Peter F Drucker** has regarded management is that part of the organisation which brings results and it has unique existence. It is an economic organ, in the sense that the value of its output is greater than its cost. Otherwise it has no reason to exist with the organisation.

**(vii) Management is multi-disciplinary :-** The subject management has been developed with the contributions of various other disciplines and subjects, like engineering, economics, psychology, sociology mathematics and statistics etc., It has taken relevant aspects from all these subjects and integrated knowledge in the form of management principles. The integration relevant knowledge from various disciplines is the major contribution of system approach to management.

#### 1-4 SIGNIFICANCE OF MANAGEMENT :

**Peter F Drucker** has summarised the essence of management as 'under-developed countries are under-managed ; it denotes the multi-dimensional significance of management. The benefits of management can be broadly classified into two groups-organisational and social.

**(a) Advantages to the organisation :**

**(i) Achievement of objectives :**

Basically organisations are formed to achieve the predetermined objectives. like sales volume, market share and ROI. Managers are appointed to achieve the objectives, hence the responsibility lies on the shoulders

of the managers to attain objectives. So in turn the managers perform them with the assistance of the team of their subordinates. As such, the achievement of objectives is assured with the process of managerial activities.

**(ii) Profit generation and growth :-** The basic task of managers is to produce surplus out of their operations over the cost of inputs. The more output that the manager can produce with the same input, the greater will be the profit generated. Profit is essential for the survival and growth of business. The firm can undertake more expansion and diversification programmes when profits are ploughed back substantially. Thus, profits and growth are interlinked.

**(iii) Meeting the challenges of competition :-** The present corporate area is not better than the battle field. Competition is galloping in terms of more competitors, more products, variety of products, and more consumer education and information. Managers formulate appropriate strategies to counter and cope up with competition.

**(iv) Providing directions and innovation :-** Like a captain to a ship, managers provide meaningful and positive directions to the organisation to reach the destination successfully. To-day, innovation is the hall mark of success and inevitable for smooth sailing. Innovation means finding new, different and better ways of doing the existing tasks. In business world, innovation refers to creating additional value to the existing products and services in terms of the difference it makes to consumers. Managers plan, coordinate and direct innovation to reach the destination.

#### **(b) Advantages to the society :**

Today, social process depends on organisational progress. Managers out of their activities in and out of the organisation cause certain benefits to the society. They are:

**(i) Employment :-** The expansion and diversification activities of the managers in organisations create more employment to the society. This is more pertinent for a developing country like India.

**(ii) Effective utilisation of resources :-** Society contains and provides resources to the organisations. Managers utilise them effectively in such a manner to cause positive effects to the society in terms of standard of living and social development.

**(iii) Discharging social responsibility :-** Managers undertake various programmes to discharge social responsibility through satisfying the interests of share holders, customers, and society, etc., Thus they create positive relations with the internal and external environment and create good business ecology in terms of culture, science, technology and peace.

Thus, the importance of management highlights its essence and indispensable existence in the organisational and social context.

### **1-5. MANAGEMENT Vs. ADMINISTRATION :**

In common parlance, people feel that there is a difference between administration and management. It is regarded that administration deals with the determination of overall objectives and strategies of an enterprise, and is basically a thinking function. Whereas management is concerned with their implementation and

deemed as a doing function. That is why, Oliver Sheldon quotes that administration is a decision-making function and management is an executive function. Likewise, several authors have raised controversies between management and administration. They are as follows:

**(i) Administration is above Management :-** Traditional authors like *Oliver Sheldon, Milward, Spriegel, Ordway Tead, and Florence* have opined that administration deals with policy formation, whereas management performs policy execution in the organisation. As such, administration is mostly top level managerial job and management is concerned with middle level and lower level managerial activity. Hence, *William Spriegel* has pointed out administration is that phase of an enterprise that concerns itself with overall determination of objectives and policies. Management, on the other hand, is an execution of policies. It is shown in the following figure.

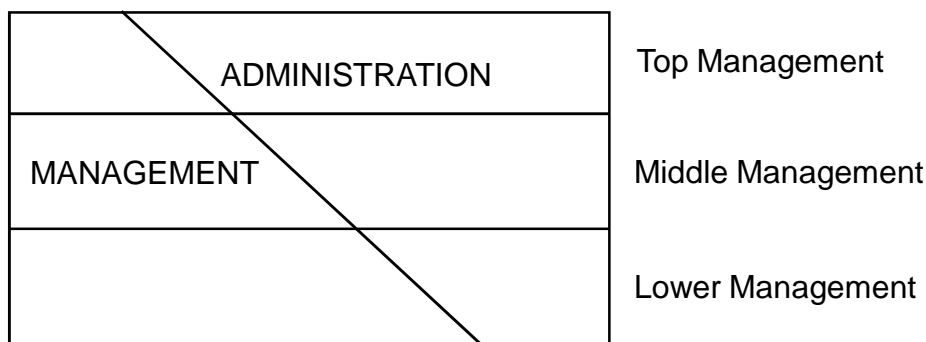

Top management people in the business organisation, like Board of Directors and Managing Director perform more of administration function and less of management functions. Middle level managers like functional managers and departmental heads carry out both the functions almost equally, however administration declines. Whereas lower level managers like supervisors, junior officers deal with mostly management tasks and very low administrative activities.

**(ii) Administration is a part of Management :-** According to this approach management is the whole activity and administration is a part of it. So management is a wider term that includes administration. Authors like *EFL Brech, and Kimball and Kimball* considered, that management is a generic term where as administration is a part of it. *Brech* has described that Management is a social process entailing responsibility for the effective and economical planning, and the regulation of the operation of an enterprise. Administration is that part of management which is concerned with the installation and carrying out of the procedure.

**(iii) Management and Administration are similar :-** The third approach states that administration and management are synonyms of the same function, and the terminological conflict between them is only misleading. Both of them perform the same functions but in two different fields, the term administration is popular in government and public organisations, and the name management is famous in business enterprises. This approach is supported by popular authors like *Henry Fayol, Mc. Farland, William Newman, Terry* and many others. *Fayol* has stated, all undertakings require planning, organisation, command, coordination and control and in order to function properly, all must observe the same general principles. We are no longer

confronted with several administrative sciences, but with one which can be applied equally well to public and private affairs.

The third approach is more universally accepted than other approaches. Even, this difference between management and administration is slowly disappearing. Many authors have titled their books as Business Administration. Hence, in the present day world they are used as synonyms.

## 1-6. MANAGEMENT - SCIENCE OR ART :

For a long time, there is a dilemma regarding the nature of management, whether it belongs to the category of Sciences or Arts. Specifications of nature of management is necessary to determine the process of learning of management. Hence, in order to find out the nature of management, it is required to know what is a science and an art.

**1. Management as a science :-** When one observes sciences like physics, chemistry, biology, and engineering etc., it is clearly evident that they endeavour to furnish consistent hypothesis, principles, laws and theories regarding certain aspects. Science explains phenomenon based upon experimentation, for eg., why apple falls on earth and how carbon dioxide will be created etc., Experimentation brings out distilled truths, they in turn formulate principles, and a set of principles is, known as theory, that is how science develops. Thus science is a systematised body of knowledge. Hence, *Keynes* rightly observes, Science is a systematised body of knowledge, which establishes relationship between cause and effect.

Science is based upon logical consistency, experimentation, evaluation, systematic explanation and analysis. Scientific principles establish cause and effect relationship between various factors. The validity of principles can be verified as they provide a reliable basis for predicting future events. The principles are exact and have universal applicability. How far management has possessed these characteristics has been verified below.

**(a) Systematised body of Knowledge :-** Several management thinkers like *F.W. Taylor, Henry Fayol, Chester I. Barnard, Follett, and Drucker* etc., have provided so many principles regarding the body of knowledge to formulate management theory. But all these principles are subject to modification based upon the factors like nature of organisation, corporate philosophy, level of technology and quality of people, etc.,

**(b) Universal Application :-** Scientific principles are derived from basic truths and they can be applied and practised in all situations and at all times, it means, they have universal application. The fundamental principles of management can be universally applied. Hence *Taylor* quotes, The fundamental principles of management are applicable to all human activities from individuals to corporate enterprises.

However, it is agreed by so many authors that great majority of management principles are to be engineered and modified depending upon the environmental conditions like culture, nature of people, fiscal policies of the governments etc., and also according to time.

(c) **Cause and effect relationship - factors :-** Principles of sciences explain cause and effect relationship between/among various factors and while explaining the consider only quantitative factors which are exact. Where as management relies not only on quantitative factors but also on qualitative factors in order to explain cause and effect relationships in the organisations. Quantitative factors are exact, whereas qualitative factors like customer relations, human relations etc., are inexact. Hence, management is not as exact as other sciences.

(d) **Empirical Confirmation :-** Scientific principles are testable and these tests are capable of repetition with same result. Thus rationality of scientific system can be maintained. Where as, it does not happen clearly in the case of management principles. As many of them lack empirical evidence and are not testable.

Thus, the analysis mentioned above states that management contains characteristics of a science a partially and it is not a pure science. Hence, it is known as a inexact science.

**2. Management as an Art :-** For long time management is considered as an art. Even *Follett's* popular definition regarding management states that management is the art of getting things done through and with the people. When science is deemed as systematic body of knowledge which can be acquired through study, art can be regarded as skill that can be developed through experience and practice mostly. Art is related with getting results through the application of skills. It is concerned with the understanding of how particular work can be performed, i.e., know-how. This is more important management because basically managers deal with human beings whose behaviour is not structured; it is dynamic and unpredictable. That is why managers are needed to make use of more creativity, skills and techniques than principles. Hence, *Terry* states "Art is bringing about of a desired result through application of skill". Now, let us observe how far management has possessed the features of an art.

(a) **Learning through experience :-** Arts like music, painting, sculpture, driving, etc., can be learnt mostly through regular practice and experience even though knowledge of certain basic principles is necessary. It is true that management to some extent is an art, because managers can acquire human skills mostly through practice and experience. But to evolve structures and to solve technical problems the knowledge of theory is essential.

(b) **Creativity :-** In order to become more skillful in a particular art, creativity i.e., thinking in a new dimensions and ways, is vital. Management is creative like any other art. Creativity is a major dimension in managerial success.

(c) **No single way to do :-** Securing success in arts is mostly personal, i.e., depending upon knowledge and presentatin of an individual. And there is no single best way to complete a particular task. This is very much true in management, especially in solving the problems. Because every problem is unique and needs a distinct solution.

**(d) Result-oriented approach:-** The process of management is directed to achieve certain results like any other art. Because, any art is directed to secure a particular outcome. Likewise, management has to ensure the completion of projects on time and aims at achieving maximum productivity at lower costs.

As mentioned above, management contains certain characteristics of arts also.

**Management is both science as well as art :-** It can be observed from the above discussion that management possesses the characteristics of a science and an art. Managers use both scientific knowledge learned from study of principles and art, that is skills acquired through experience, in managing an organisation. In fact, science and art are not contradictory, but they are complimentary. For instance, in order to practise well in science like medicine, the doctor must treat same disease of two patients differently. So also for any art, there are certain underlying principles. Thus, in practice there is no subject which is categorised as a pure science and a pure art. They are combinations of both with varying proportions. This is more true in the case of management where managers need both theory and practice to build up professional concerns. By nature, management is more art than science, but the proportion is changing with the growing application of sciences, like mathematics and statistics etc., to solve managerial problems and to improve exactness in decision making. This is also true only to a limited extent. That is why, it can be stated that management is both a science and an art.

### 1-7 MANAGEMENT AS PROFESSION :

There is a controversy regarding the nature of management, that is whether management can be considered as a profession or not. This problem has become more acute with the growing size of the organisations, because the growth of joint stock companies has caused the divorce between ownership and management. In the past times, the small and petty business concerns were looked after by the owners. But in the present day joint stock company, owners are shareholders who can not participate in the day-to-day business activities, managers who are paid people, look after them and have become answerable to the shareholders. As a result, ownership is separated from managership and caused the management to grow as a profession.

The dictionary meaning of a profession is 'a calling in which one professes to have acquired specialised knowledge'. So, *Carr-Saunders* states, "A profession may be defined as an occupation based upon specialised intellectual study and training, the purpose of which is to supply skilled service or advice to others for a definite fee or salary". In the broad sense, it refers to any occupation by which a person earns livelihood by practising it, but it must have certain underlying principles for study, for eg. medicine, engineering and law can be considered as professions. Hence, *Cogan* opines, "A profession is vocation whose practice is founded upon an understanding of a theoretical structure of some department of learning of science". The Purpose of a professional is that he should use skills not for his self-satisfaction but for the larger interests of the society, further his success should not be measured in terms of money alone. All occupations are not professions, only some



occupations are profession. Hence, *Mc. Farland* has stated the following criteria to consider an occupation as a profession.

- (i) The existence of an organised and systematic body of knowledge.
- (ii) Formal method of acquisition of the knowledge.
- (iii) Existence of an association with the goal of professionalisation of that particular occupation.
- (iv) The formation of ethical codes to guide the conduct of professionals who practise.
- (v) The charging of fee based on the services of professional. But the priority must be for social service not for money.

It can be observed that management possesses some of the above characteristic while others are not appearing. For instance, management satisfies the first two features of a profession, i. e., existence of knowledge and acquisition of knowledge. Whereas there is no proper regulatory body like Indian Medical Council for medical practitioner and Institute of Cost and Works Accountants of India for cost accountants. Even though we have All India Management Association, it functions more as an advisory or technical body than a regulatory association. As far as ethical code is concerned, there is no proper and uniform code of conduct. There are no restrictions of licensing on the entry of management.

Hence management is considered as emerging profession not as an established profession. However, *Peter F. Drucker* has warned against too much professionalisation and licensing of management and stated that it is dangerous and undesirable in all spheres.

## 1-8. MANAGERIAL SKILLS :

*Robert L. Katz* has identified the following types of skills for managers. These skills are essential to perform management functions successfully and to enable to managers to cope up with contemporary changes and challenges.

**(i) Technical Skill :** - It is the proficiency of various methods, processes and procedures in performing activities. It needs working with tools and techniques. For instance, to perform the tasks successfully, mechanics must have the knowledge of tools and accountants should use proper techniques. These are known as 'technical skills'.

**(ii) Human Skill:-** It is the ability to work with people and to build up cooperative effort. In order to create effective team work, managers should have good human skills like sociability, fraternity, warmth and ability to get along with others, etc.,

**(iii) Conceptual Skill :-** It is the ability to think about the whole system and to understand the relationships among the various elements through proper analysis. It also involves the skill to integrate and coordinate the various divergent activities.

(iv) **Design Skill :-** Managers should have the ability not only to find out the problem but also to solve them successfully. Design skills refer to solve problems in such a way that will benefit the organisation.

However, these skills are differently needed at various levels of management. Technical skills are more required at lower or supervisory level of management. Whereas, more human skills are necessary for middle level managers. And managers at the upper level should possess a great amount of conceptual and design skills.

### 1-9 UNIVERSALITY OF MANAGEMENT :

Universality of management means transmission of management knowledge from one organisation to a different organisation, from one country to another country and from one manager to incumbents through training and development. Management principles have universal application because management is a universal process. Universality of management principles also means that managers are transferable from one country to another country. This concept has come into lime light ever since management was recognised as science, because science and scientific principles have universal application. But since management is regarded as inexact science, its universal application is questioned. Some authors have favoured it, where as others negated. We can observe their arguments as follows:

**Arguments against Universality :-** Some authors including *Drucker, Dale and Farland* etc., did not agree for universal application of management principles. They state that management of organisation is situational and is subject to environmental conditions. *Peter F. Drucker* opined that the skill, the competence, and the experience of maneagement can not, as such as transferred and applied to the organisation and running of other institutions. Their arguments are described below.

- (a) The behaviour of the people working in the organisation is highly influenced by the culture. Culture consists of attitudes, beliefs and values of a society. The culture of one country is different from culture of another country, in such a case management can not be applied equally in all the countries.
- (b) The objectives of business and non-business organisations used to differ. Infact business enterprise may possess single objective, a non-business organisation consists of multiplicity of objectives.
- (c) The problems of variious business enterprises are different and not similar.
- (d) Management and policies of organisations are often guided by the philosophies in those organisations. Philosophy means attitude towards activities. Some organisations may follow liberal and open systems approach, where as others are traditional and conservative. In such a case management practices are certainly different.

**Arguments for Universality :-** Popular authors like *F.W. Taylor*, *Henry Fayol*, *Koontz*, *O'Donnel*, *Myers* and several others supported the universality of management. According to them, the basic principles of management are universal and can be found in all types of organisations in any country. *F.W. Taylor*, the Father of Scientific Management, stated that there are a number of elements which are common to the process of management in the different spheres of life and on the basis of which a general theory of management can be evolved. *Fayol* quoted that the principles of management are of universal nature and apply to every type of organisation, hence he was known as universalist. According to *Harie*, *Ghiselli*, and *L. W. Porter*, there was a high degree of similarity in managerial behaviour patterns and many of the variations disclosed were due to identifiable cultural dimensions. They have organised a study of 3,600 managers in a fourteen countries which supports this approach. Thus, management can be regarded as a universal phenomenon. The various arguments for the universality of management are mentioned hereunder.

- (a) Management process, planning, organising, staffing, directing and controlling, is found in all organisations irrespective of country and culture. Hence, management process can be regarded as universal. In practice, some functions may be concerned more important in certain enterprises and vice versa.
- (b) Managerial knowledge and principles can be transferred from one manager to another through proper training and development.
- (c) It is often confused that management basics and techniques are one and the same, but they are different. Management techniques are specific in nature and changes keeping in view of the situational needs. Whereas basics of management remain constant in all organisations. That is why, techniques may vary from one nation to another, but not basics.
- (d) The fundamental principles are distilled truths and can be traced with equal utility at various levels of management in all concerns.
- (e) Since management principles are universal, multinational corporations are able to expand their operations to different nations, and consultancy experts used to carry-out their assignments in various countries.

From the arguments mentioned above, it can be realised that basic management process and principles have universal application but techniques are situational. Management principles are flexible and capable of adaptation, that is why developing countries are importing managerial knowledge from advanced nations and modifying them according to their environment conditions. Thus, management can be transferred from one nation to another. Hence, *Koontz* and *O'Donnell* opined, "One would not necessarily expect an automobile designed for use in deserts or jungles to be the same as one planned for high-speed super highways, even though the physical science which underpins both remains the same". The same is truth in the case of management also.

**SUMMARY :**

In this chapter, an attempt is made to crystallise the nature and features of management concepts and significance. Further, it is also discussed whether management is science or art, and stated that it has the characteristics of both the areas. It is also mentioned that management principles are universally applicable subject to environmental modification.

**1.11. KEY WORDS :**

**1. Management :** It is the art of getting things done through and with people through creating an effective environment.

**2. Objectives :** Destination to a specific course of action.

**3. Organisation :** A firm established to achieve commercial objectives. It is a group of people formed to achieve prescribed goal. The terms enterprise and company are used as synonyms.

**4. Universality :** It refers to application of knowledge and skills throughout the world.

**1.12. SELF ASSESSMENT QUESTIONS:**

1. Explain the meaning, features and significance of management.
2. Distinguish between administration and management.
3. Whether management is science or art. Discuss.
4. What is a Profession? How far management can be professionalised?
5. Describe the managerial skills.

**1.13. FURTHER READINGS :**

- \* Dalton Mc Farland, "Management Principles and Practices", Mc Milan, New York.
- \* James A. F. Stoner, R. Edward Freeman, "Management", Prentice-Hall of India, New Delhi.
- \* Oliver Sheldon, "The Philosophy of Management", Sir Issac Pitman, London.
- \* Ghiselli E. E., Haire M., and Porter L.W., "Managerial Thinking", An international Study, John Wiley, New York.
- \* Harold Koontz, Cyril O' Donnell and Weirich, "Management", Mc Graw Hill, New York

**Y V S Prasada Rao**

**Lesson -2****EVOLUTION AND APPROACHES TO MANAGEMENT****OBJECTIVES:**

The objectives of this lesson are to :

- know the development of managerial knowledge from time to time
- know about various approaches to study management

**STRUCTURE :**

- 2.1 Evolution of Management Thought
- 2.2 Approaches to Management
- 2.3 Summary
- 2.4 Key words
- 2.5 Self - Assessment Questions
- 2.6 Further Readings

**2.1 EVOLUTION OF MANAGEMENT THOUGHT**

**2.1.1. Introduction :-** Management thought is as ancient as human civilization, because the need for management has arisen ever since people started forming into groups. The rich history of the management made it resourceful, varied, and multi-dimensional. Management is transient from time to time depending on the prevalent philosophies. Hence, a large variety of concepts emanated in the field of management from classical to neo-classical to modern. The chronological contributions of management thinkers is known as 'Evolution of Management Thought' which have formulated management theory.

The initial efforts towards management principles could be traced from the organisational practices of Roman Catholic Church, military organisations and the Cameralists who proposed certain principles like scalar chain, specialisation, line of command, selection of subordinates and their training and unity of doctrine, etc., Later on, certain valuable contributions pertaining to mostly the field of human resources and relations came from James Watt, Robert Owen, Charles Babbage and Henry Poor. However, the real development of management thought has started with the scientific management by F. W. Taylor.

**2.1.2. SCIENTIFIC MANAGEMENT BY F. W. TAYLOR :**

Frederick Winslow Taylor has made the maiden attempt to systematise the management theory through the publication of "The Principles of Scientific Management" in 1911. Eventually, he is known as the Father of Scientific Management. He wrote Scientific Management with his long experience as an engineer at various

levels of functioning from an apprentice to the chief engineer of a steel company. His Philosophy is also known as 'Taylorism'.

According to Taylor, it is not proper to find just a way for doing some thing, a manager has to find the one right way. His major concern was to increase efficiency in production, it includes not only to lower costs and raise profits, but also to increase pay for workers through their higher productivity. Further, he emphasized that analysis, planning and control of work should be separated from the execution of work. Managers should be responsible for analysis and planning of work in advance, whereas workers should be responsible for the performance of the work as per plans.

**Principles of Scientific Management** :- Taylor has endeavoured to introduce scientific approach in business management and wanted to make it as exact as possible. The objective of Taylorism was to enhance production and productivity in the Organisations. The basic principles are stated as follows:

- (a) Replacing rules of thumb with science,
- (b) Harmony in group action than discord;
- (ic) Cooperation than individualism;
- (d) Working for maximum output than restricted output;
- (e) Developing workers to the fullest extent

#### **Elements of Scientific Management :**

- a) Separation of Planning from doing
- b) Modifications to organisation
- c) Improvement in the methods of work
- d) Differential piece-rate system
- e) Mental Revolution.

Initially, Taylorism has been vehemently criticised both by trade unions and managements. Trade unions have stated that Taylorism develops splits among the workers based on the efficiency and workers are made puppets because of time and motion studies. Managements also have criticised that it may be costly and burdensome to implement the scientific management in the organisation. But later on the importance of Taylorism has been well recognised and practised by all the quarters throughout the world. The management thinkers like Henry Gantt, Frank Gilberth and William Gilbreth have made significant contributions like Gantt Chart and therblig (motion study) etc., and popularised Taylorism.

#### **2.1.3. OPERATIONAL MANAGEMENT THEORY - HENRY FAYOL (1841 - 1925) :**

The contributions of Taylor and others are aimed mostly at workshop level and did not concentrate on the development of overall organisation structure. At about the same time, the real contributions to the promotion of management at the organisation level are given by French Industrialist Henry Fayol. That is why he is

known as Father of Modern Operational Management. Through his long executive experience, he wrote several papers on technical and administrative aspects, they were published in a single volume in French named as "Administration Industrielle et Generale" in 1916. It was translated into English in 1929 bearing the title "General and Industrial Management".

Fayol used the term 'administration' instead of 'management' indicating that both are same and can be applied equally well to public and private activities. According to him management is a universal phenomenon, and the principles are flexible not absolute but they are usable regardless of changing conditions.

### ***Classification of Industrial Activities :***

According to Fayol, all activities of Industrial or business concerns could be divided into six groups.

- (i) Technical activities - dealing with the process of production, manufacture and adaptation of materials into goods.
- (ii) Commercial activities - relating to buying, selling and exchange of materials and goods.
- (iii) Financial activities - concerning with the search for and the best use of capital.
- (iv) Security activities - relating to the protection of property and personnel.
- (v) Accounting activities - consisting of stock - taking ,costing and statistical analysis.
- (vi) Managerial activities - including planning, organising, commanding, coordinating and controlling.

**Fayol's Management Process :-** Fayol states management is to seen as a process of comprising five functions - planning, organising, commanding, coordinating and controlling. In his words, to manage is to forecast and plan, to organise, to command, to coordinate and to control.

**General Principles of Managemt :-** Henry Fayol has provided fourteen principles to manage the organisation successfully and to build up an effective organisational structure. Fayol has stated that the list of principles is not exhaustive but suggestive. Still to-day, they are regarded as golden principles of organisation . They are enumerated as follows :

**1. The division of Work :-** Division of work is to be adopted to take advantages of specialisation. It can give maximum productivity and efficiency. According to Fayol, the division of work applies to all kinds of work, both technical and managerial.

**2. Authority and Responsibility :-** According to this principle, authority and responsibility should go side by side. The right to give orders and to command is called authority. The obligation to accomplish objectives or performances is known as responsibility.

**3. Discipline :-** It refers to respect for agreements which are directed at achievements, obedience, application, energy and respect. It means obedience, respect of authority and observance of established rules.

**4. Unity of Command :-** It means that employees should receive orders from one superior only. There should not be multiple losses to one subordinate because it will lead to divided responsibility and escapism. Fayol mentions that a body with two heads is difficult to survive.

**5. Unity of Direction :-** According to this principle, each group of activities with the same objective must have one head and one plan. Unity of direction insists better coordination among various activities to achieve the overall goals of the enterprise.

**6. Subordination of Individual Interest to General Interest :-** Individual interest must be sacrificed to common interest, if there is a conflict between these two. When individual interest and common interest differ, it is the responsibility of the management to reconcile them.

**7. Fair Remuneration :-** Remuneration means *quid pro quo*, i.e., something in return. Remuneration and methods of payment should be fair and equitable to provide the maximum possible satisfaction to employees and employer.

**8. Centralization :-** It refers to concentration of authority in the hands of few, i.e., top management. There must be good balance between centralisation and decentralisation of authority. Extreme centralisation and decentralisation should be avoided.

**9. Scalar Chain :-** According to Fayol, scalar chain is a chain of superiors and subordinates from the highest ranks to the lowest ranks. Command and communication must go through this chain. However, in order to pass the communication fastly a gang plank may be created between bottom line workers as shown hereunder.

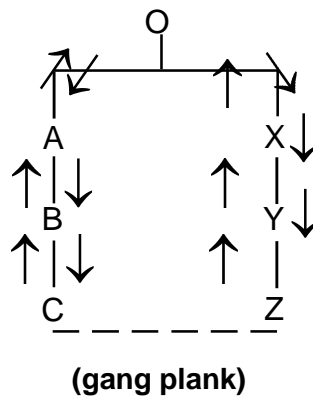

**10. Order :-** It implies that right man in the right job and right material in the right place. It is broken down into two - material order and social order.

**11. Equity :-** Equity is the combination of justice and kindness. There should not be nepotism, bias and favouritism and all should be given just and fair treatment irrespective of levels. Otherwise discipline in the organisation falls down.

**12. Stability of Tenure :-** It refers to the longterm existence of people in the organisation. Employee turnover, i.e., changing of employees from one organisation to others must be minimised.



**13. Initiative :-** Initiative is regarded as thinking out and execution of a plan. The managers must encourage the subordinates to show their initiative even at the cost of their vanity.

**14. Esprit de corps :-** *Esprit de corps* is a combination of french words, it means Unity is Strength. There must be unity among not only the workers in the organisation but also between workers and management.

### **MANAGERIAL QUALITIES AND TRAINING :**

- (a) Physical Qualities - health, vigour, tone and address.
- (b) Mental Qualities - ability to understand and learn, judgement and adaptability.
- (c) Moral Characteristics - firmness, initiative, loyalty, tact and dignity.
- (d) Technical Qualities - operational skills, techniques and tools.
- (v) Experience - ability to deal with various managerial situations.

Fayol has stated that there was over concentration regarding training in technical aspects, but managers are also need a training in management as well as in other related fields. The contributions of Henry Fayol have received over whelming response and acceptance throughout the globe. They have pionered in the development and training of so many managerial aspects. Later, management thinkers like Sheldon, Mooney and Reily, Herbert Simon, Urwick., L. Gullick, V.A. Graicunas and others contributed to the development of administrative theory of Fayol.

### **2.2.4. BUREAUCRATIC THEORY - MAX WEBER (1864 - 1920) :**

Max Weber, a German academecian belonging to Berlin University, has presented his views on the forms of structures. He has analysed the functions of different types of organisations like church, government, military and business organisations and written many books, of which the outstanding treatise was "The Theory of Social and Economic Organisation".

He stated that the organisations are of three types - charismatic, traditional and brureaucratic. According to him, beureaucratic organisations are the most efficient form of all. They are first named as Rational - legal; they are rational because they have specific objectives and the organisation is designed to achieve them. They are also legal because authority is stemmed from a clearly - defined set of rules, procedures and roles. It is the most rational means of carrying imperative control over human beings. He has given the following characteristics of bureaucracy.

- (a) Specialisation ;
- (b) Heirarchy of Authority ;
- (c) Rules and Regulations;

- (d) Impersonality;
- (e) Trained Personnel;

Eventhough, Weber's contributions were questioned and criticised in the early days as they brings lethargy, and red-tapism into the organisations, bureaucratic form has become inevitable with the growth in size of the organisations. Because small and pretty concerns may be performed with personal directions, but the present day huge and gigantic organisations must consist regulatory framework to govern lakhs and millions of employees. That is why, to day most of the organisations are bureaucratic.

### 2.1.5. ADMINISTRATIVE MANAGEMENT - HERBERT SIMON :

Herbert Simon is an American political and social scientist, he has made many significant contributions in the field of administrative behaviour and decision-making, his books, "Administrative Management" published in 1947 and "The New Science of Management Decision" published in 1967. The following are his major contributions.

**(i) Organisation :-** According to Simon, Organisation is a complex network of decisional process. The best way to analyse an organisation is to findout where and by whom the decisions are made.

**(ii) Decision making :-** He opines that decision-making is the core of management and management is synonymous with decision-making. Hence, he is known as Decision Theorist. Decision making consists of the following phases :

- a) Intelligent Activity
- b) Design Activity
- c) Choice Activity

**(iii) Organisational Communication :-** Simon recognised the vital role of communicatin in organisation deciesion-making process. There are three stages in the communication process - initiation, transmission and receipt of information.

**(iv) Bounded Rationality :-** A rational man is one who makes the decision with clear information and gives due consideration to all the factors available to make decision. Simon states that complete rationality in decision-making is impossible. He has argued that bounded rationality is more pragmatic.

**(v) Administrative Man :-** Administrative man follows bounded rationality and satisficing approach in decision-making than the maximising approach of economic man.

### 2.1.6. CONTRIBUTIONS OF PETER F. DRUCKER :

Peter F. Drucker, is the living legend in the field of management. He has made many outstanding contributions to the development of management principles.

**(i) Nature of Management :-** Drucker advocates that management is creative and innovative in nature rather than burecureratic. Because managers practise their activities in an ever changing environment, they

always deal with the human beings whose behaviour is complex and unpredictable. He has warned that too much professionalisation of management is dangerous.

**(ii) Management by Objectives (MBO) :-** MBO is regarded to be his remarkable contributions to the management thought. It consists of environmental scanning, identification of key result areas, setting objectives for departments as well as to subordinates, motivation and performance appraisal. He opines that MBO as a management philosophy than a management technique.

**(iii) Management Functions. :-** According to Drucker management is a specific economic organ. Hence it is a part and parcel of the organisation which brings required results. He sees management through its tasks.

**(iv) Organisation Structure :-** Drucker has vehemently opposed bureaucratic organisation structures because of their many dysfunctional effects. They are detrimental to the growth, so they should be replaced. Drucker always advocates for the parallel growth of second line managers because whenever the existing managers vacate their offices, organisations should not suffer from the non-availability of experienced managers. If there is gap, it is detrimental to the performance of the organisation.

**(v) Organisational Changes :-** Further, Drucker has forecasted that organisations face many changes because of rapid social and technological changes. Hence, dynamic organisation structures are essential than static and bureaucratic structures.

**(vi) Federalism :-** Federalism means centralisation of control and decision-making in decentralised structure. Drucker has felt the need for close links between the decisions adopted by the top management on the one hand and by autonomous unit on the other hand.

**(vii) Activity Analysis, Decision Analysis and Relation Analysis :-** In the words of Drucker, organisation is a means to the end of business performance and business results. The first question that every manager must ask himself is what is our business and what it should be ? Then the organisation should be designed to attain the objectives of the business.

The contributions of Drucker, especially his futurism, objective-orientedness and perception of changes stood as hallmarks in the management evolution. His writings have been well-appreciated not only in capitalistic countries but also in communist nations.

### **2.1.7. CONTRIBUTIONS OF HAWTHORNE EXPERIMENTS - HUMAN RELATIONS :**

The pioneering attempt towards intensive and systematic analysis of human factor was done by Hawthorne Experiments. Elton Mayo, F.J. Roethlisberger, William Dickson and others have organised these experiments in Hawthorne plant of General Electric Company, Chicago for a period of 8 years from 1924 to 1932. Basically these experiments were designed to study the relationship between productivity and physical working conditions like illumination and working hours. The plant had employed about 30,000 workers and was paying good salaries, pension and other benefits. The experiments have given surprising results that improvement in productivity depends upon more on social and human factors like morale, satisfactory relationships among

workers, and effective management. Effective Management involves understanding human behaviour, group behaviour and satisfying the people through interpersonal skills as motivating, counselling, leading and communicating. This phenomenon is known as Hawthorne Effect. The summary of their research findings is mentioned as follows.

- (a) Consideration of Social factors in production ;
- (b) Group Behaviour;
- (c) Leadership ;
- (d) Communication Process;
- (e) Participation and Recognition ;

Hawthorne effect has brought new horizons in management thinking. It has recognised the key element for productivity and organisational success, that is the human factor. It has given birth to a new discipline, known as "Organisational Behaviour".

#### **2.1.8. THE BEHAVIOURAL SCIENCE THEORY :**

The behavioural science is concerned in the understanding of human behaviour. It includes Psychology which seeks to study individual behaviour, Sociology which studies group behaviour, and Anthropology which studies the influence of physical, biological and cultural factors on human behaviour with the help of scientific and empirical research. Based on these studies, it has been able to develop verifiable and pragmatic propositions about human behaviour in organisation. It offers these as guidelines to practising managers in decisions and actions affecting the organisational personnel. This approach has formulated the following propositions.

- (a) Organisations are techno-economic, and social units.
- (b) Individuals differ in their attitudes, perceptions, abilities, needs and values and these change over a period of time.
- (c) Conflicts in organisations between individual and between the management and the employees are inevitable and to some extent they are necessary for progress.
- (d) Interpersonal behaviour in organisation is influenced by a variety of factors.

Over the last forty years, important contributions have been made to the knowledge of human behaviour in organisations by a number of social scientists. The notable authors among these are, Mary Parker Follet, Chester Barnard, Abraham Maslow, Douglas Mc. Gregor, Kurt Lewin, Rensis Likert, Chris Argyris, George Humans, Victor Vroom and many other scholars. The major areas of research of the behavioural scientists have been the following:

- (i) Implications of technology for organisation structures.
- (ii) Organisational behaviour as a result of interactions of people within and with the external environment.

- (iii) Communication systems in the organisation.
- (iv) Group Dynamics, and group processes of cohesiveness, group problem solving, and group decision making, etc.,
- (v) Management of change in organisations.
- (vi) Leadership in organisations, motivation process and techniques.

In conclusion, it may be stated that Behavioural Approach represents an improvement over the Human Relations Approach. While both the approaches emphasised the importance of the human factor in industry, the behavioural approach has been preconceived notions about the causes and their effect on behaviour of people organisations. It adopted a purely diagnostic approach and advised practising managers to adopt the same.

## **2.2. APPROACHES TO MANAGEMENT :**

Management is multi-disciplinary and has drawn the contributions from various fields of study, like sociology, psychology, mathematics, systems analysis and managerial experiences etc., As a result, the management subject has become very complex, because really managing people is a turbulent activity in organisations, hence, Harold Koontz has called it as "The Management Theory Jungle". Further, the evolution of management over the period of time has developed different approaches for managerial analysis. These approaches are popularly known as Patterns of Managerial Analysis. Each approach endeavours to explain the nature and content of management and each of them employs its own different beliefs, views and principles.

Harold Koontz and Heinz Weirich recognises twelve approaches to study management and to clear the jungle. They are stated as follows :

### **2.2.1. THE EMPIRICAL OR CASE STUDY APPROACH :**

This approach studies management through managerial experiences and management cases. The rich experiences of proficient managers and their activities in turbulent organisational situations are formed as cases, and their study enables the incumbents to understand the reasons for successes or failures. That is why it is also known as Case Approach or Management Experience Approach. This approach is developed by Earnest Dale, Mooney and Reily, Urwick and others. The basic features of the approach are mentioned below.

- a) management theory can be developed by studying large number of managerial experiences, because certain generalisations can be made out of them.
- b) Successful Managerial experiences can be passed from one practitioner to another or to the aspirants of management , as a result management knowledge continues.

This approach has been developed as case method, it acts as a tool for teaching management. It enables to organise proper classroom discussions and to develop diagnostic and analytical skills in management students

and incumbents. However, it suffers from limitations like differences in situations, non recurrence of past situations and dynamic nature of future.

### **2.2.2 THE INTERPERSONAL BEHAVIOUR OR HUMAN RELATIONS APPROACH :**

The human relations approach recognises the importance of people in the performance of organisational objectives. It is the outcome of thoughts developed by behavioural scientists, like Mayo, Roethlisberger and Mary Parker Follet, who look at the organisation as a group of people. According to this approach, the study of management should revolve around the human behaviour, since management is the art of getting things done through people. It emphasises the development and application of concepts like human relations, leadership and motivation based on individual psychology. Interpersonal relations refer to person-to-person relations, especially between superiors and subordinates in the organisation.

Even though, this approach has recognised the significance of human relations and the need for harmonious relations for the achievement of organisational objectives, it ignores the importance of various managerial functions like planning, organising and controlling. Because mere psychological training alone can not make effective managers.

### **2.2.3. GROUP BEHAVIOUR APPROACH :**

Individuals often work as groups in the organisations. In fact, organisation is a group of people working for the achievement of predetermined objectives. It primarily studies group behaviour patterns including team work, group dynamics, participative management and leadership etc., Sociology and social psychology have given major contributions to this approach. It has gained greater momentum in recent times because it is realised that the behaviour of individuals as groups is complex, unpredictable, and varies from situation to situation, it has given rise to the subject "Organisation Behaviour".

The study of human interactions and human behaviour has occupied more importance in management, because man is a product of social system. Often individual behaviour is not decided by organisational factors like pay and working conditions, but it is influenced by many social forces like culture, attitudes, group norms and conflicts. But there is something more than group behaviour management, managers need to practise several concepts, principles and techniques to generate required performance. Moreover, this approach must develop closer integration with organisation structure design, staffing and planning.

### **2.2.4. THE CO-OPERATIVE SOCIAL SYSTEMS APPROACH :**

This approach is developed by Pareto and Chester I. Bernard, it consists of both interpersonal and group behavioural aspects, and states that cooperative system among various positions determines organisational performance. The organisation is predominantly a cultural system composed of people who work in cooperation. Hence a cooperative system of management can be developed by understanding the group behaviour of people. The following are the basic features of this approach.

- (a) Organisation is described as a social system, it is a system of cultural relationships.
- (b) In order to achieve the organisational objectives, co-operation among the group members is essential.
- (c) Harmony between organisational goals and group goals should be achieved for effective management.
- (d) It has recognised the significance and role of informal groups in formal group, i.e., organisation.
- (e) It has identified the relationship between the external and internal environment of enterprise.

It also implies that managerial decisions must not be based on the expectations of one group but should also consider the interests of other groups. But it overlooks many managerial concepts, principles and techniques. But it has highlighted the role of informal organisation, informal communication and cooperation to achieve organisational performance.

#### **2.2.5. THE SOCIO-TECHNICAL SYSTEMS APPROACH :**

It is relatively a modern approach in management, pioneered by Trist, Emery and Rice. This approach states that in order to solve managerial problems it is necessary to consider not only the cooperative social systems but also the technical systems and their mutual influence. Because the level of technology influences the quality and the qualifications of people and also the working conditions. It decides the pattern of human behaviour at work, leadership and controlling. The major features of this approach are mentioned below :

- (a) Technical system has great effect on social system which consists of personal attitude and group behaviour.
- (b) It focuses attention on production, office operations and other areas where close relationships between the technical systems and people exist.
- (c) Social system of the organisation is governed by social laws and individual forces. Technical system contains technological forces like machinery, procedures and working conditions.
- (d) The interaction between social and technical systems, technical aspects of the work are modified by social aspects.

Thus, this approach has recognised the importance both social and technical systems for effective managerial performance. This approach is highly oriented to industrial engineering.

### 2.2.6. THE DECISION THEORY APPROACH :

Managers are those people who solve problems and make decisions throughout the day, and the crux of managerial performance is influenced by their decisions. Hence, this approach centres management activity around the decision-making, i.e., the selection of a suitable course of action from among various alternative courses of action. It emphasises that the organisation is a decision-making unit and the manager is decision maker. Decision-making affects all the areas, all the functions and activities in the organisation. This theory is contributed by Herbert Simon, March, Forrester and others. It consists of the following characteristics.

- (a) Organisation is treated as a combination of various decision centres. The level and role of organisational members are determined on the basis of significance of decisions they take.
- (b) It emphasises that decision making must be as much rational as possible because quality of decision affects the organisational effectiveness.
- (c) Decision-makers must develop proper information system and should consider various social and psychological aspects while making decisions.

This approach emphasises the importance of decision making for effective managerial performance. It has clarified the manner of shrewd decision-making through the development and application of various modern techniques of decision making. It also emanated the concept of Management Information System (MIS) through which managers can secure continuous and accurate information for the purpose of sound and quick decision-making. The decision-making concept is some times too narrow and some times too wide than the task of management. It does not cover organising and implementing properly.

### 2.2.7. MANAGEMENT SCIENCE APPROACH :

This approach is borrowed to management after the World War - II, to properly utilise the available scarce resources. Mathematics as a subject strives to achieve optimality in decision making and finds single feasible solution. The approach applies various mathematical principles and models to business decision making, so it is also known as Mathematical Approach or Operations Research. Churchman has stated that it is the application of specific measures, tools and techniques to operations of system with optimum solution to the problem. The basic feature of the approach is presented below.

- (a) It looks management as a logical process, expressed in mathematical symbols and relationships. Management is seen as a problem-solving mechanism with mathematical processes, tools and techniques.
- (b) It emphasises model building - the logical physical presentation of a problem. The model is a representation of objects, events, processes or systems.



- (c) It quantifies the variables in a problem to the possible extent, since only quantifiable data can be inserted into a method to measurable result.
- (d) It puts the model, and its variables, constraints and goals in quantitative terms for calculation and to solve managerial problems.
- (e) The mathematical approach covers decision-making, systems analysis and some aspects of human behaviour.

The application of mathematics and statistics has increased exactness in management which is inexact. As a result, quantification is enhanced and managers are able to find optimum solutions especially in the areas of production and finance. Various mathematical techniques and tools like sampling, linear programming, games theory, and simulation etc., have found scientific solutions to managerial operations. However, this approach is severely criticised in many ways, because managerial problems are beyond mathematical perception. At some times, the impact of qualitative factors like workers relations and market relations have far reaching consequences. As a result, quantifying as much as possible, gives absurd and dangerous results. Especially, this theory has limited application in the areas of personnel and marketing where qualitative factors play major role.

### **2.2. 8. THE SYSTEMS APPROACH :**

This approach has gained the attention of many management thinkers in recent era, it has become popular only after 1950's. It is an integrated approach which considers management in totality based on empirical data. The central idea of this approach is that any object should depend on a method of analysis involving simultaneous variations of mutually dependent variables. A system is a set or assemblage of various interdependent and inter-related variables. i.e., subsystems, so as to form a complex unity. It is a totality of various parts and sub-parts in orderly arrangement according to some plan or scheme. Kast and Rosenzweig define, "A system is an organised or complex whole; an assemblage or combination of things or parts forming a complex unitary whole".

The systems approach considers existence and influence of various subsystems systematically. An organisation is a processing system consists of production and marketing of goods and services through planning, organising and staffing etc., It is dependent on its external environment and it is a part of larger systems like the industry to which it belongs, the economic system and the society in general. The enterprise receives inputs, transforms them and exports the output to the environment. It is described in the following diagram.

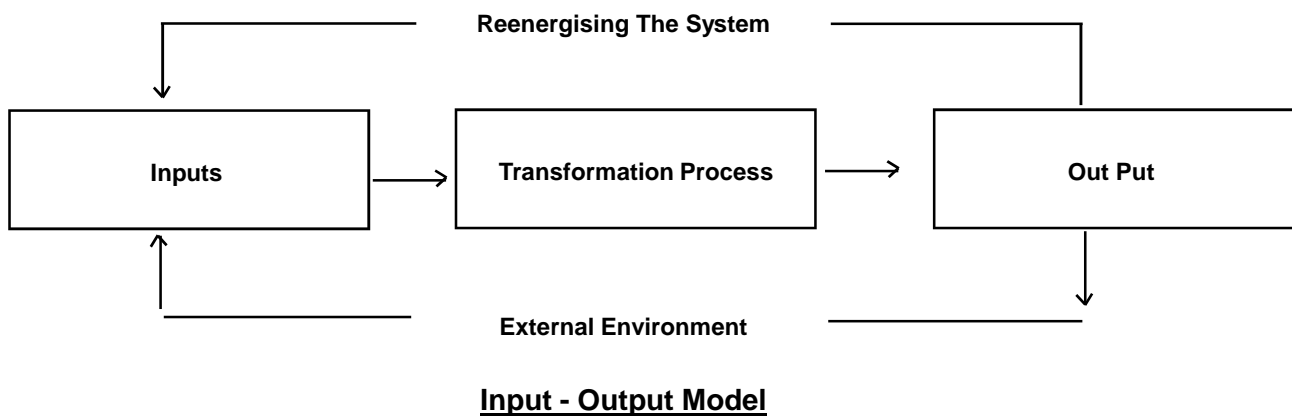

The model explains that organisation assumes inputs from the society (external environment), transforms them and gives output to the society and also for itself. Inputs are in the form of raw materials, people, technology and methods. Transformation consists plans, programs, operations and achievement. Outputs are the deliveries from the organisation in the form of goods and services, employment, taxes and economic development. Any business enterprise is an open system which permits interactions between the organisation and environment.

### **2.2.9. CONTINGENCY OR SITUATIONAL APPROACH :**

This approach has added a new dimension to management. The central idea of contingency approach is that there cannot be a particular management action which is suitable for all situations. It states that an appropriate action is one which is designed on the basis of external environment, and internal states and needs. The supporters of contingency theory argue that systems approach does not adequately explain the required relationship between organisation and its environment. Contingency approach tries to justify the gap by suggesting the way to respond to active environment. Therefore, it is also regarded that contingency approach is an extension to the system approach.

The predominant features of the situational or contingency approach are given below.

- (a) Management is entirely situational and there is nothing like universal and common principles of management or one best way of doing a particular thing. The managerial actions depend on the circumstances and environment.
- (b) Internal functioning of organisations must be consistent with the demands of the organisation task, technology, external environment and the needs of its people.
- (c) Contingency approach explains that since organisation interacts with its environment continuously, neither the organisation nor its subsystems are free to take absolute actions.

- (d) The activities of managers are contingent and dependent on certain action outside the system or subsystem concerned.

The theory is very complex because it is difficult to determine all relevant contingency factors and their relationships, hence it also suffers from empirical testing. Moreover, it is only reactive but not proactive.

#### **2.2.10. MANAGERIAL ROLES APPROACH :**

One of the latest approaches to the study of management is the Managerial Roles Approach given by Professor Henry Mintzberg of McGill University. This approach has observed what managers do actually and from such observations it has drawn conclusions regarding management activities, they are known as Managerial Roles. Even though, many researchers have studied the actual work of managers, Mintzberg gave more systematic and transparent presentation.

After careful study of the activities of five chief executives practically in a variety of organisations, Mintzberg has come to a conclusion that managers do not perform the classical management process, i.e., planning, organising, staffing, directing and controlling. Instead, they perform a variety of activities, called Roles. He has stated ten roles of managers consisting of three broad categories.

##### **(A) Interpersonal Roles :**

- (i) The figure head role - The manager performs ceremonial and social duties and the representative of the organisation.
- (ii) The leader role - He leads the groups.
- (iii) The liaison role - He performs talks with various people particularly with outsiders.

##### **(B) Informational Roles :**

- (i) The recipient role - He receives information about the operation of an enterprise
- (ii) The disseminator role - He passes information to subordinates.
- (iii) The spokesperson role - He transmits the information to those outside the organisation.

##### **(c) Decision Roles :**

- (i) The entrepreneurial role - He innovates and pioneers the activities.
- (ii) The disturbance - handler role - He settles disputes and conflicts.
- (iii) The resource - allocator role - He allocates the resources towards various ends.

- (iv) The negotiator role - He deals with various persons and groups of persons.

Mintzberg has provided an innovative and descriptive presentation of managerial activities, it has made managers practically to various dimensions and to improve the performance.

### 2.2.11. MC KINSEY'S 7-S APPROACH :

The contemporary approach to the field of management is the 7-S frame work developed by the reputed management consultancy firm, Mc. Kinsey & Company in 1980's. In 7-S, each S stands for a distinct concept. If managers emphasis these concepts, the organisational performance will improve. They are explained as follows :

Strategy	....	Systematic Action and allocation o f resources to achieve company aims.
Structure	.....	Organisations structure, and authority - responsibility relationships.
Systems	....	Procedures and processes such as informatrion systems, manufacturing processes, budgeting and control processes.
Style	....	The way management behaves and collectively spends its time to achieve organisational goals.
Staff	.....	The people in the enterprise and their specialisation into the organisational culture.
Shared Values	....	The values shared by the members of an organisation. They are also known as superordinate goals, the objectives which are of prime concern for any body in the organisation.
Skills	....	Distinctive capabilities of an enterprise.

The efforts of this approach is to highlight the managerial activities have ben appreciated around the world. In fact, they have supplemented a new dimation of thinking, to managerial activities. However, some people state that these concepts are already popular in other names, only new names are given to the existing ideas.

### 2.2.12. THE OPERATIONAL APPROACH :

This approach believes that management is a conglomeration of knowledge from various fields of study along with its own theory. The operational approach to management draws together the related knowledge of management from other subjects relating to the managerial job.

This approach recognises that there is a central core of knowledge about managing which is related to the field of management like planning, departmentation, line and staff and various control techniques. In addition, this approach absorbs knowledge from other fields such as systems theory, decision theory, behaviour theories, soccial systems as well as from mathematics and statistics. This approach is drawn in the diagram which followed.

The figure mentioned below describe the ptttern of interlinking basic management theory with other pertinent subjects subscribing to the development of management. In fact, it is not totally a new approach, it

is a combination of all other approaches and showing the growth of management. As the approach attempts to draw the related knowledge regarding the management functions from the other subjects, it is also known as "Management Process Approach".

The operational approach crystallises the complex nature of management, and provides broad and easy to understand framework of management. This approach provides flexibility, scope for innovation, improvement and progress to management. It has provided purposeful philosophy to management. However, it is also criticised as this approach chains universality of management principles, while in practice management differs from organisation to organisation and from level to level. It does not recognise the representing and coordinating as distinct functions of management.

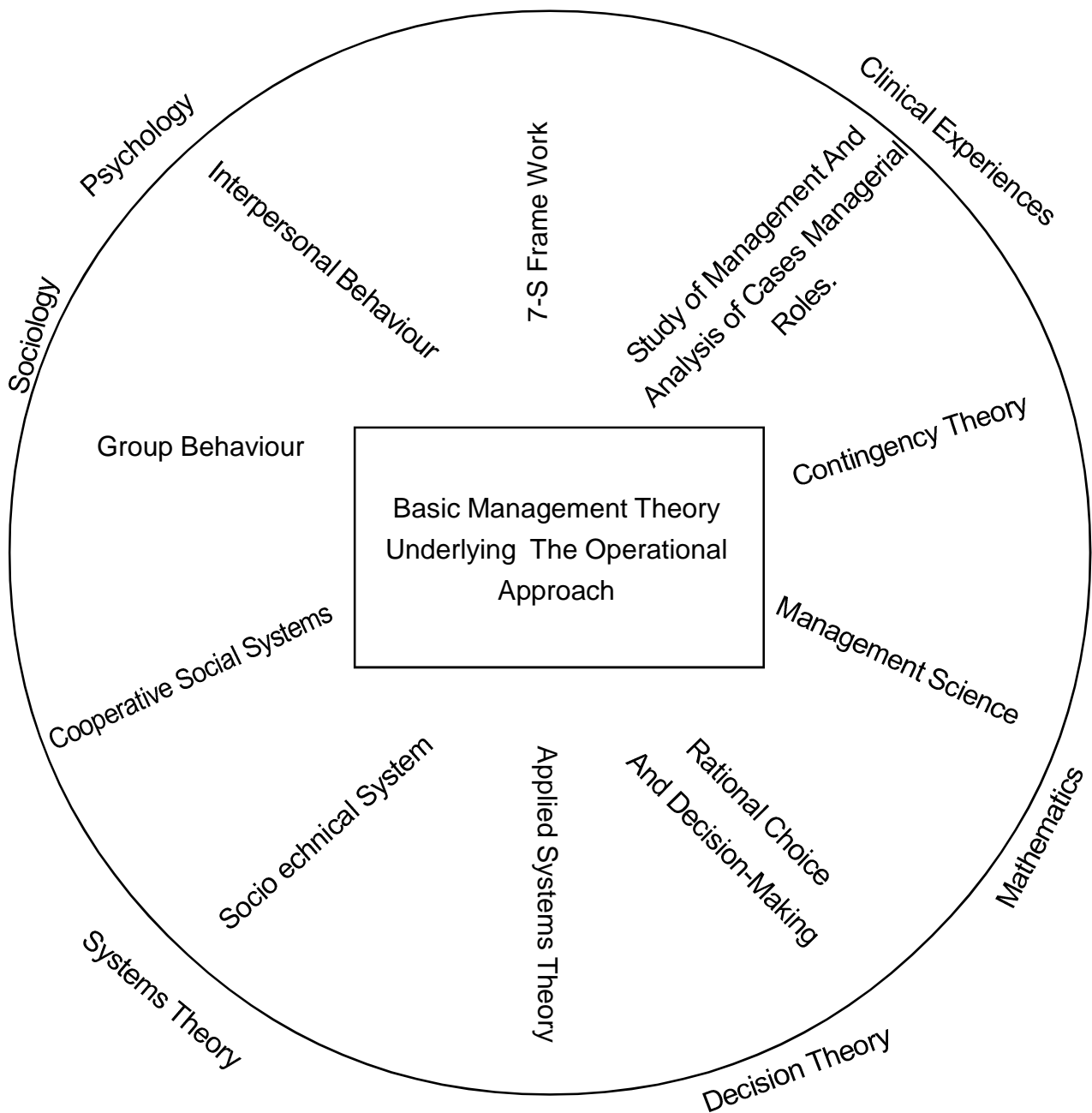

The analysis mentioned above, state that no approach has completely explained the nature of management and free from shortcomings. In fact, the nature of management is also that of critical because it deals with large and complex organisations which are often uncontrollable and beyond the human perception. However, a positive sign is emerging in the form of convergence and integration of various approaches. This is, of course provided by the operational approach as compared to other approaches. Thus, the operational approach is more accepted in management parlance. Because it does not reject or neglect other approaches but integrates them for the growth of managerial knowledge and performance.

### 2.3. SUMMARY :

In this lesson, it is endeavoured to bring out the development of management thought consists of the contributions of several important management thinkers -- classical, neoclassical and modern. Further, various approaches to the study of management are also presented from empirical approach to operational approach, and concluded that management is interdisciplinary because the nature of management job is complex and needs multi-dimensional thinking.

### 2.4. KEY WORDS :

**1. Principles of Management :** Henry Fayol has given fourteen general guidelines to the practice of management.

**2. Hawthorne effect :** Employees try to group together to improve performance or to change their behaviour due to their team spirit and positive relations.

**3. Behaviour :** Behaviour is what a person does. It depends on the personality of a person and his environment.

### 2.5. SELF ASSESSMENT QUESTIONS:

1. Explain the contributions of Taylor
2. "Fayol is considered as the Father of Modern Management Theory". Discuss.
3. Write a note on the Decision Theory.
4. What is systems approach to management? Describe its salient features.
5. Explain the contributions of Peter F Drucker to management.
6. What is the operational approach to management?

### 2.6. FURTHER READINGS :

- \* Allen Louis, "Management & Organisation", Mc. Graw Hill, Tokyo, 1958.
- \* Simon H.A., "The New Science of Management Decision", Harper, New York, 1960
- \* Chester I Barnard, "The Functions of Executive ", Harvard University Press, Cambridge, 1937.
- \* Heinz Weirich and Harold Koontz, "Management", Mc Graw Hill, New York, 1994.
- \* Etzioni A, "Modern Organisations", Prentice Hall of India, New Delhi, 1964.

**Y V S Prasada Rao**

**Lesson - 3****MANAGEMENT PROCESS AND ENVIRONMENT****OBJECTIVES:**

The objectives of this lesson are to :

- clarify the management process and functions.
- elucidate the goals or tasks of managers.
- understand the impact of external environmental factors on business.

**STRUCTURE :**

- 3.1 Management process and functions.
- 3.2 Goals or Tasks of Managers
- 3.3 Environment
- 3.4 External Environmental Factors
- 3.5 Internal Environmental Factors
- 3.6 Interaction between External and Internal Environments.
- 3.7 Summary
- 3.8 Key words
- 3.9 Self-Assessment Questions
- 3.10 Further Readings

**3.1. THE MANAGEMENT PROCESS AND FUNCTIONS :**

The task of management requires the accomplishment of a series of activities, it is known as Management Process. These activities follow a rational sequence and they accomplish the objectives of an enterprise. Management is a process which bring the valuable human and financial resources together and encourages the people for the achievement of organisational goals. The entire process is regarded as a social process because the fulfilment of organisational efforts depends upon the willingful cooperation of people. Hence, Brech states, "Management is a social process entailing responsibility for the effective and economical planning and regulation of the operation of an enterprise".

But the statement of activities/ functions in management process varies from one author to another. Henry Fayol, one of the early management thinkers has described management functions as planning, organising, commanding, coordinating and controlling. Brech has stated that management process includes planning,

organising, motivating, coordinating and controlling. Whereas Gullick and Urwick have given the list of management functions in the name of POSDCORB. In which each letter denotes one management function, i.e., planning, organising, staffing, directing, coordinating, reporting and budgeting. As such, every author in management has given a separate list of management functions. However, the management process stated by Koontz and O'Donnell is more universally accepted, which includes planning, organising, staffing, leading (directing) and controlling. They are discussed as follows.

**3.1.1 Planning :** - Planning means determination of future course of action to achieve the goals. Any manager while undertaking the tasks and responsibilities, has to start with planning. It involves determination of objectives and means i.e., actions to achieve them, of the enterprise. Planning is regarded as a thinking function than a doing function. It involves basically decision-making, that is deciding in advance what to do, when to do, how to do and who is to do. Planning precedes all other management functions like organising, staffing, directing and controlling. It is a continuous process that takes place at all levels of management.

Planning is concerned with future. Because planning process involves different degrees of futurity. Some parts of the organisation require for many years into the future while others require planning over a short period only. For example, capital expenditure is more of long-term nature, while budgeted for a year has short term orientation. The former is called strategic planning or long-range planning, and the later is called short-term planning.

**3.1.2. Organising :-** After determining the objectives and means of the enterprise, managers put them into practice through organising. It involves the process of dividing the work, grouping the similar activities, defining and delegating authority and responsibility to various positions, and establishing the relationships for the purpose of enabling the people to work more effectively. According to Koontz and Weihrich, organising consists of establishing an intentional structure of roles for people to fill in an organisation. The purpose of organisation structure is to help in creating an environment for better human performance. Organising function contributes to the efficiency by ensuring that all the required activities will be performed and results can be secured.

Organising is an ongoing process of structuring and arranging the part of the organisation. It involves analysis of activities to be performed for achieving organisational objectives, grouping them into various departments, assigning the activities to individuals and delegating them necessary authority to carry out the activities properly and providing coordination vertically and horizontally in the structure.

**3.1.3. Staffing :-** It means filling the positions which are created in the process of organising with necessary people. On the other hand, it is regarded as manning the organisation. The purpose of staffing is to keep the right man in the right job. According to Keith Davis, the process of staffing includes human resources planning, recruitment, selection, and training and development, compensation, motivation, integration, maintenance and separation. It is a continuous function in the organisation, because after separating the people from the organisation again recruitment takes place.



**3.1.4. Directing** :- After determining the objectives of the organisation through planning, creating the positions with activities through organising, manning the positions with required people through staffing, the next function that managers come across in the management process is directing. It is the real executive function in which managers directly deal with subordinates. The biggest problem managers face is that people do not work properly according to the objectives of the organisation. So it is necessary to mould and channelise it and direct their behaviour towards achievement of objectives. Direction may be described as a managerial function which is related with instructing, guiding and inspiring human factor in the organisation to achieve organisational goals.

Though effective planning and good organisation are very important steps in management process, there is yet another function which is more important to attain and ensure the end result that is directing. It makes people to work hard and put in the best possible efforts in executing the desired and planning tasks. Thus directing function involves guiding, inspiring, overseeing and leading people for attaining or achieving the targetted goals. It is an interpersonal aspect of management as it involves motivating and influencing the subordinates to secure the desired goals and levels of action from them. Directing is not an easy and simple task as it involves management of human resources. As, much of the human behaviour is complex and still unexplored fully, directing throws as a tremendous challenge to the managers.

Ernest Dale states, "Directing is telling people who to do and seeing that they do it to the best of their ability". According to Massie, "Directing concerns the total manner in which a manager influences the actions of subordinates. It is the final action of a manager in getting other, to act after all preparations have been completed".

Thus, directing is mainly giving orders and seeing that those orders or instructions are carried out in the desired manner. Directing deals with human behaviour and personal feeling like beliefs, faiths, sentiments, greed, etc.,

### **PROCESS OF DIRECTING :**

The directing process involves basically the following steps.

**(i) Giving orders or instructions** :- This is the first step in directing. Orders are given with the intention to start change, or stop an activity. In a formally organised business the superior officer is legally empowered to give orders to his subordinates and they execute such orders. A good order must be clear and unambiguous, reasonable and within the capacity of the subordinate, should set time limit for completion and finally the order must be in writing as far as possible.

**(ii) Continuous guidance** :- After giving the order or instructions the executives job is not finished. He must guide them continuously and see that the instructions are carried out properly as some times the subordinates

may try to deviate or violate it to suit their own personal convenience. Sometimes by innocence the given orders are not executed properly. Therefore continuous supervision and surveillance is very much essential.

**(iii) Motivation :-** Motivation means the various forces that impire an individual at work to willingly use his capacities fully, for the fulfilment of the given objectives. Motives provide direction to human behaviour as they are directed towards certain conscious or sub-conscious goals. A goal is an outward stimulus for the motive to work. So direction also involves motivating subordinates for the achievement of organisational objectives.

**(iv) Communication :-** This involves understanding the needs, requirements, aspirations, problems and suggestions of the subordinates and acting accordingly. It is a two way process. The subordinates must be encouraged to communicate freely and fearlessly with their bosses.

**(v) Discipline and Rewards :-** Superiors must maintain proper discipline and see that everything is under control. Those who do their tasks well, obey orders without complaints and extent full co-operation must be generously rewarded.

**(vi) Leadership :-** Providing leadership to subordinates is vital. It provides a sense of confidence among subordinates. It sets a model for them and they work with zeal.

**3.1.5. CONTROLLING :-** Controlling is the last stage in the managerial process, it is last but not least. After formulating the plans, designing the organisation structure, securing the required personnel, communicating the information, leading the people towards the goals; The need for controlling arises, that is implementation of plans and monitoring the performance. In planning phase, management determines, how the resources should be utilised to get the objectives, at the controlling phase managers see whether the resources are utilised in the same manner as decided. As such, controlling accomplishes the management process.

Especially, planning and controlling are inseparable functions. Planning formulates the objectives, controlling confirms the realisation of objectives. The objectives set in the planning process, act as standards or targets for measuring the performance of subordinates. Planning starts again where controlling ends. That is why, planning and controlling are regarded as siamese twins. All the other functions in the management process are progressive functions, where as controlling is regressive function. Because all other functions march ahead toward next function, but in controlling, manager looks back what happend to the performance of objectives, and formulates the measures to rectify the deviations and to ensure the achievement of planning.

According to Koontz and O'Donnel, "Controlling is the measurement and correction of performance in order to make sure that enterprise objectives and plans devised to achieve them are being accomplished".

George R. Terry has defined, "Controlling is determining what is being accomplished, that is evaluating the performance and, if necessary , applying corrective measures so that the performance takes place according to plan".

**Controlling Process** :- The various steps involved in the controlling process are described in the following diagram.

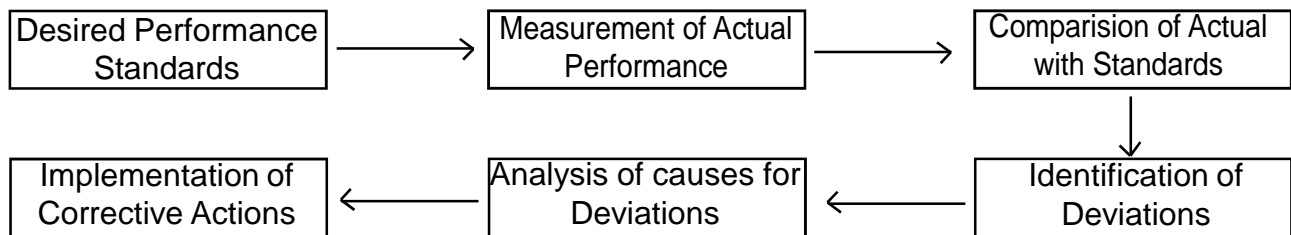

**(i) Establishment of Standards** :- Effective Controlling needs good standards to measure the performance of subordinates. Standards are the yardsticks or targets against which the actuals can be measured. Standards can be drawn from the objectives of the organisatin which are decided in planning. Departmental or functional objectives can be drawn from organisational objectives, and departmental objecives emanate individual objectives. Individual objectives inturn converted into standards. By definition, standards are criteria of measuring performance.

There are two types of standards - Quantative and Qualitative. Quantitative standards like sales targets and profit ratios are measurable and precise, whereas qualitative standards like maintenance of harmoneous relations in the case personnel managers are not measurable.

**(ii) Measurement of Actual Performance** :- It involves measuring the performance in respect of a work in terms of control standards. The presence of standards implies a corresponding ability to observe and state the nature of existing conditions. Performance of subordinates can be recorded from periodical reports, letters, correspondence charts, graphs and direct observbations, etc., Peter F. Drucker mentions that it is much desirable to have clear and common measurements in all key areas of business. According to him, for measuring tangible and intangible performance, measurement must be clear, simple, rational, reliable and relevant.

**(iii) Comparing Actuals with Standards** :- After setting the standards and recording the performance, the most important step is comparing the actual performance with standards, and finding not only the deviations or differences but also the reasons for deviations. The actual performance compared with standards reveals that the people in the organisations are progressing in the right direction or not.

After comparing the standards with actual performance, if it is found that there is a gap between standards and performance, that is known as deviation. Deviations are tolerable to some extent, if they are beyond prescribed limit an analysis should be made to find out the reasons for such deviations. Because it helps management to take up proper corrective measures.

**(iv) Correction of Deviations :-** The last phase of the controlling requires measures should be taken to maintain the desired degree of control and to rectify the deviations. However, it is to be realised that control measures are not like electric switches, which automatically control the electric current. Suitable control measures are to be selected after careful review.

The management process mentioned above is universal to all the managers irrespective of levels and organisations with little deviations. It is a never ended process, because after controlling is completed, it gives the basis for planning and again planning starts. That is why management process is represented like a circle as follows.

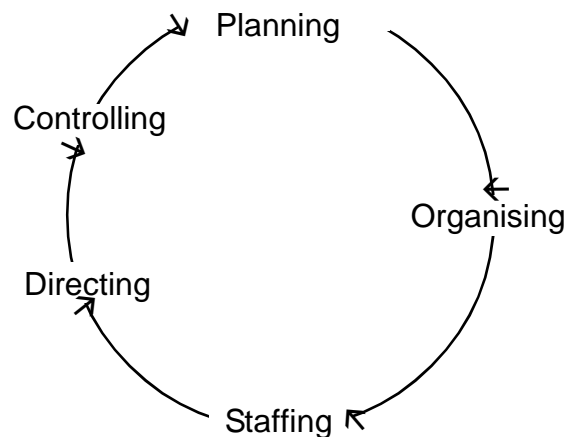

Ernest Dale has suggested innovation and representing along with the above function. Because innovation is the key for managerial success and representing refers to the role of manager as figure head.

### 3.2 THE GOALS OR TASKS OF MANAGERS :

It is essential to state the goals or tasks of the managers working in the organisations, otherwise it is not possible to gauge their performance. Basically, there two types of organisations., business and non-business. Non-business managers argue that the aim of business executives is clear and simple, i.e., profit maximisation. But actually profit is only a surplus over costs. In a very practical sense, the logical and true goal of all managers, in all organisations, whether business or non-business, to create surplus. Hence, it is the basic

responsibility of managers to establish an environment in which people can achieve group goals with the least possible amount of time, money, material and personal dissatisfaction.

Executives must ensure accomplishment of organisation goals with available resources through subordinates in optimum manner. It is true, even in the case of a non-business enterprise like police department where there are no units or production and profits, managers, i.e., police officers, must strive to accomplish the activities with minimum or available resources. Because there may be ambiguity in objectives of the non-business organisations, but activities are clear for any organisation. In order to clear the ambiguity in managerial goals and to improve excellence in operations, Koontz and Weirich have stated the objectives of managers as productivity, effectiveness and efficiency.

**(a) Productivity :-** Productivity is the basic concern for all organisations, hence it is recognised as the most important common goal of managers. Productivity is to be distinguished from production, that is mere increase in production is not a positive trend of productivity. An increase in production is possible with proportionate increase in all factors of production without any great effort on the part of managers. Successful enterprises create surplus through productive operations. Productivity can be defined as output-input ratio within a time period with due consideration for quality, The formula can be stated as follows :

$$\text{Productivity} = \frac{\text{Output}}{\text{Input}}$$

The formula shows that productivity can be improved

- (i) Producing the same output with lesser inputs.
- (ii) Producing more output with the same inputs.
- (iii) Producing more output with less inputs.

Total factors of productivity combines various inputs, like personnel, material and capital to arrive at a composite input. For a long time, productivity remained as a concept at workshop level, but Drucker recognises it as a managerial tool also. He opines that, the greatest opportunity for increasing productivity is surely to be found in knowledge of work itself, and especially in management.

**(b) Efficiency :-** Efficiency refers to the achievement of objectives and performance of activities with least possible resources and creating maximum possible surplus. It means doing things right. So, efficiency can be measured with the help of quantity of surplus, one who creates more surplus is regarded to be more efficient. Efficiency can be qualified in terms of profits, sales volume and minimisation of costs, etc. Hence, efficiency remains as the hallmark of managerial performance and organisational progress.

**(c) Effectiveness :-** Effectiveness refers to achievement of objectives in right manner, that is, doing right things. Effectiveness is different from efficiency. For example, maximisation of profits refers to efficiency,

whereas obtaining profits in socially accepted manner is effectiveness, i.e., securing profits after proper payment of taxes, loans and charging reasonable prices to customers.

Productivity implies efficiency and effectiveness in achieving individual and organisational performance. Hence any manager should achieve productivity through efficiency and effectiveness of operations.

### 3.3. ENVIRONMENT :

The performance of any business organisation largely depends on its environment. Environment refers to the conditions or forces which prevail around an organisation and exert influence on its operations. According to William F. Glueck and Lawrence R. Jauch, "Environment includes factors outside the firm which can lead to opportunities for and threats to the firm."

Environmental factors can be broadly divided into two types - External and Internal.

### 3.4. EXTERNAL ENVIRONMENTAL FACTORS :

External factors lie outside the organisation and they are beyond the control of the organisation. They include economic factors, socio-cultural factors, political factors, legal factors, technological factors, natural factors and global factors. All these elements are macro - level and they pertain to the whole economy. They are common to all firms and to all industries in the economy and influence similarly. They are also known as "General Environment" or "Remote Environment". They are never constant and keep on changing from time to time. They pose challenges to the companies, and in turn companies derive and capitalise opportunities from such challenges. Because, every challenge provides an opportunity. Hence, Richman and Copen depict external factors as "they are largely if not totally, external and beyond the control of individual industrial enterprises and their managements. These are essentially the 'givers' within which firms and managements must operate in a specific country and they vary, often greatly from country to country."

As such, the macro - level factors are uncontrollable, infact, they control the firm in several cases. The success of a company depends on its adaptability to the external environment. For eg., when the cost of import rises, the opportunity for import substitution increases. Similarly, when the dollar value hikes, exports grow. So they deserve specific attention for all managers. They are described below.

**3.4.1 Economic Factors :-** The origion and the growth of business organisations are highly influenced by economic environment. Economic environmental factors refer to all those forces which have economic influence on business. They include national income, per capita income, distribution of national income, money supply, business cycles, capital formation, savings, stage of economic development, industry, agriculture and infrastructure, etc.,

There is a close and positive relationship between business and economic factors. When economic factors are favourable and growing, then, business also moves positively and prospers, and vice versa. For instance, when national income and per capita income raise, the demand for all firm increase. Infact, business depends on economic factors. Further the movement of economic forces is also important. For example, assume that national income is constant, if disparities in the distribution of national income increase, the rich becomes rich and poor becomes poor. Consequently, the demand for luxurious goods increases.

**3.4.2 SOCIO-CULTURAL FACTORS :-** The behaviour of people inside and outside the organisation is influenced by the society in which they live. Hence, socio-cultural factors have profound influence on the performance of workers, corporate philosophies and the attitude of customers. They consist of attitudes, values, family system, institutions, religion, caste, education, customs, traditions, and ethics, etc. Often socio-cultural factors give surprising conclusions. For instance, although plays an active role in moulding the attitudes of people ; habits and traditions are more geographical and local.

The changes in socio-cultural factors provide new business opportunities. For example, increasing women education and employment emanate demand for readymade foods and clothes. Today, the culture is moving more global because cultural transmissions, and infiltrations have been occurring at a rapid pace. For instance, westernisation has become common in Indian food and dressing habits. In the same way, Indian saris, shalwar-kameez, and jewellery are more respected in the west. The business managers should notice all such changes and plan accordingly.

**3.4.3. POLITICAL FACTORS :-** Political environment influences the business to a great extent in a mixed economic system like India, where the Government policies can make or mar any business. Government refers to the political party in power, whenever the political party in power changes the Government policies also change. Consequently, certain business activities get favourable effect and others obtain disadvantage.

Political environment mainly consists of three political institutions, they are - legislature, executive and judiciary. They exercise very high influence in promoting, developing and directing the business activities. Legislature formulates the policies, executive includes council of ministers administers the policies and the judiciary reviews the policies. An acute business manager must understand their implications intelligently and should shape the business accordingly.

**3.4.4 . LEGAL FACTORS :-** Of course, legal environment and political environment are closely related. Legal environment consists of acts, taxes and other legal provisions concerned to business. The Government through various enactments create legal environment which may be conducive or negative to the business growth. The legal environment reflects the Government's philosophy.

In several countries, a number of laws are promulgated to control investment and related matters, to regulate the conduct of business regarding monopolistic practices, environmental aspects and consumer protection. Many countries declared the laws to regulate competition in the public interest to eliminate unfair practices. There are also laws relating to even conduct of advertising and pricing. In India there are several enactments like MRTP Act, FEMA, Consumer Protection Act, and Pollution Control Act, etc., to regulate business activities.

**3.4.5. TECHNOLOGICAL FACTORS :-** Technological factors influence pattern of production, productivity and quality of products. Science and Technology are closely related. Scientific developments increase technological applications. According to UNCTAD, "Technology is systematic knowledge for the manufacture of a product, for the application of a process or for the rendering of a service."

Galbraith defines technology as a 'systematic application or other organised knowledge to practical tasks'. Technological developments are very fast and frequent. Hence, global perception regarding technological

improvements is essential. Technology has undergone a series of stages through transition process from manual to automatic to computerisation to robotisation. The manager who adapts contemporary technology are more successful than others.

**3.4.6 Natural Environment :-** The natural factors like resource endowments, weather and climatic conditions, topographical factors and locational factors are relevant to the genesis and growth of business. Climatic and weather conditions influence the location of certain industries such as cotton textiles and tea.

Differences in geographical conditions between markets may call for changes in the marketing mix. Similarly, availability of raw materials play a dominant role in the case of coal, and iron and steel industries in view of transportation costs. As such, several considerations pertaining to natural endowments influence the prosperity of business. Hence, awareness and source of information are vital to a manager in this regard.

**3.4.7 GLOBAL FACTORS :-** After 1990s, the liberalisation process has brought a sea change in Indian business scenario, it has resulted in globalisation of Indian economy. Globalisation refers to integration of national economy with international economies. Consequently, there would be free flow of capital and human resources from and to the national economy. Foreign enterprises are treated on par with any domestic company and foreign capital is to be viewed similar to Indian capital.

Due to the process of liberalisation and globalisation, protectionism to Indian business has disappeared and competition is increased. The sellers' markets have turned to buyers' markets. Consumer service and sovereignty has increased. Communication and transportation facilities ushered and world has become a Global Village. Hence, business responses and managerial practices must be fine-tuned to survive in global environment and competition.

### **3.5. INTERNAL ENVIRONMENTAL FACTORS :**

Factors within the organisation are known as 'Internal Factors'. These factors are controllable since organisations have control over them. Because companies can change or alter them according to their convenience and strategies. The important internal environmental factors described below:

**(i) Mission and Objectives:-** Mission can be stated as corporate philosophy and commitment which is made explicit through statements. For instance, ITC states "New Horizons and New Hopes", which explains its diversification strategies. Ranbaxy takes "to become a research based International Pharmaceutical company" which describes its commitment to quality orientation and global perception.

Corporate mission emanates its objectives. The objectives can be decided for short term and long term, qualitative and quantitative objectives, ranging from annual sales targets to dealer meets. Objectives can be grouped into three types - Corporate Objectives; Departmental Objectives and Individual Objectives. Whenever corporate objectives change, departmental and individual objectives also change.

**(ii) Human Resources :-** Human Resources refer to composition of work force, including quality and quantity of work force. It increases whenever there is a technological change in the company for example, when nationalised banks in India opted for computerisation of activities, then voluntary retirement scheme is announced for existing employees and new employees with I.T. skills are taken into rolls. The other important areas of human resources are morale, commitment and attitude of workforce which influence the strengths and weaknesses of company.



**(iii) Marketing - Mix :-** The marketing capabilities of a company are reflected in its marketing - mix which consists of product, price, promotion and distribution. If the marketing - mix is effective, then the company can face competition efficiently and sales volume raises. It also influences the financial capacity and growth of the enterprise.

**(iv) Other Capabilities :-** The financial and production capabilities also influence the strategy formulation of the company. The borrowing capacity or capitalisation ability of the organisation determines the scale of operations and product mix decisions. Inturn, they will have an impact over competition and pertinent strategies.

### 3.6 INTERACTION BETWEEN EXTERNAL ENVIRONMENT AND INTERNAL ENVIRONMENT :

The interaction between External and Internal environments has been shown in the following diagram.

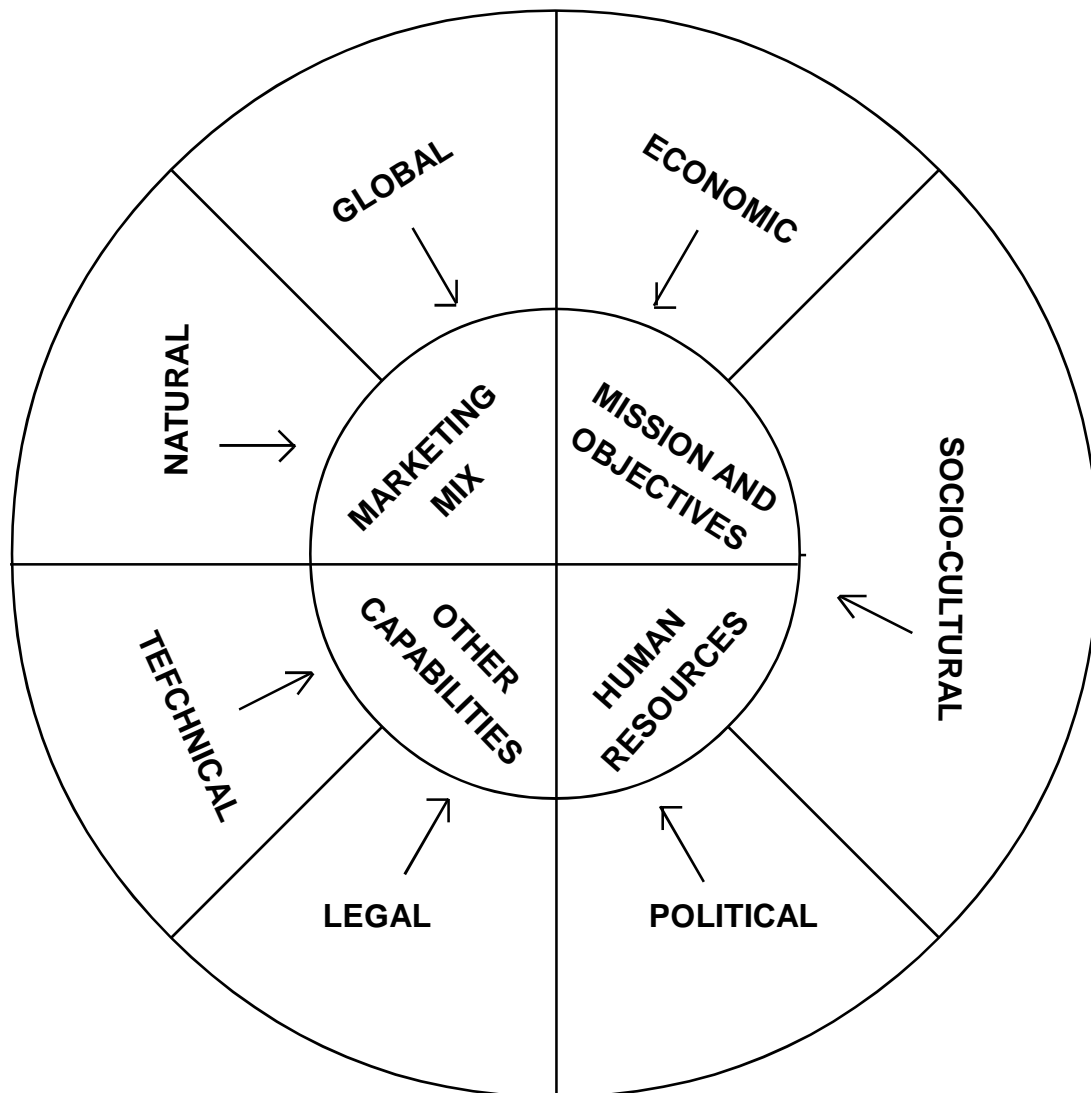

The external environment keeps on changing and creates opportunities to the enterprise. The managers must formulate suitable strategies and change internal factors accordingly to capitalise opportunities from external environment. It means internal environmental factors which are controllable are to be changed and transmitted to external environment. External Environment is an independent variable and internal environment is dependent variable. So, managers must balance both the environments to keep the organisation alive and dynamic, otherwise organisation goes obsolete and dies in course of time.

### 3.7. SUMMARY :

The lesson attempts to bring out the concepts and formulation of the managerial functions, such as planning, organising, staffing, directing and controlling. They form as a continuous process of managerial performance in the organisation. Further, the various factors of environment are also analysed as they play a vital role in managerial strategy formulation. Because, the organisations should continuously interact with the ever changing environment for their dynamic survival and growth.

### 3.8. KEY WORDS :

1. **Management Process :** The sequence of events to be performed to fulfil the task of management.
2. **Coordination:** It is the process of synchronising activities of various positions in the organisation for the achievement of overall objectives.
3. **Environment :** Business organisations operate in a set of conditions which are known as environmental factors. They can influence the activities and performance of an enterprise.
4. **Globalisation :** It is the process of integration of national economy to international economies. As a result, there can be global flow of capital and other resources.

### 3.9. SELF ASSESSMENT QUESTIONS:

1. What are the various functions of management?
2. Explain the goals of managers in a modern organisation.
3. Discuss the role and types of external forces.
4. Study the relationship between external and internal factors.

### 3.10. FURTHER READINGS:

- \* Richards, Max D., and William A. Nieland, (ed), "Readings in Management, D.B. Taraporevala Sons and Company, Bombay, 1967.
- \* Koontz, Harold and Cyril O. Donnell, "Management: A System and Contingency Analysis of Managerial Functions", McGraw-Hill, Tokyo, 1976.
- \* Drucker, Peter F., "Management Tasks, Responsibilities and Practices", Allied Publishers Private Ltd., New Delhi, 1981.

**Y V S Prasada Rao**

**Lesson - 4****PLANNING - PROCESS AND TYPES****OBJECTIVES:**

The objectives of this lesson are to :

- know the meaning and process of planning
- distinguish among various types of plans and to learn the importance of each type
- understand the primacy of objectives and M.B.O. process.

**STRUCTURE :**

- 4.1 Planning
- 4.2 Planning Process
- 4.3 Features of a good Plan
- 4.4 Advantages of Planning
- 4.5 Limitations of Planning
- 4.6 Making Planning Effective
- 4.7 Types of Plans
- 4.8 Management by Objectives
- 4.9 Management by Exceptions
- 4.10 Crisis Management
- 4.11 Summary
- 4.12 Key words
- 4.13 Self-Assessement Questions
- 4.14 Further Readings

**4-1. PLANNING**

Planning precedes all other managerial functions. Since it formulates the objectives and means of the enterprise, all other functions are necessary to carry them. Before any action is taken place, it is essential to think about it and design the future course of action, otherwise functioning would be ambiguous and performance of the organisatin could not be upto the level of desired standards. Hence, it is to be decided in advance what

to do, how to do, who is to do and when to do. Planning is the determination of future course of action. Planning is basically a decision - making function and it is thinking function. It is thinking before doing.

Planning is necessary to cope up with changes. Managers are expected to work in dynamic environment where change is regular. Planning is a tool in the hands of managers who has to compete the problems created by changes. Effective managers compete with foreseen problems and ineffective managers struggle with unexpected problems. Because a manager who plans takes the opportunities from changes and sketches the devices to utilise them properly. There are many instances in which a little planning is helpful to attain the goals. Proper planning is inevitable to overcome the objectives of the organisations. In the present day competitive world, there is no place for guess work and chance.

### ***Definitions :***

The word planning is defined by various management thinkers as follows :

Weirich and Koontz state, "Planning involves selecting missions and objectives and the actions to achieve them".

Hart describes, "The determination in advance of a line of action by which certain results are to be achieved".

According to Mc. Farland, Planning may be broadly defined as "a concept of executive action that embodies the skills of anticipating, influencing and controlling in nature and direction of change". It means managers not only must expect the changed events as accurately as possible but also should undertake necessary actions to catch hold of them and to make use of them.

Alfred and Beaty define, "Planning is the thinking process, the organised forecast, the vision based on fact and experience that is required for intelligent action". Planning is a process in which decisions are to be taken after thorough thinking, and activities should lead to pursuance of goals.

Allen Louis Opines, "Planning involves the development of forecasts, objectives, policies, programmes, procedures, schedules and budgets".

Thus, planning is primarily concerned with future and involves the selection of suitable course of action. Planning decides the kind of organisation structure, it influences the kind and quantity of people, it affects the kind of direction to the organisation and it furnishes the standards of control. Further, planning is all pervasive in the organisation. It is to be undertaken at all levels of managers in the organisation. Because all levels of managers are concerned with the determination of future course of action.

## **4.2 PLANNING PROCESS :**

Planning can be accomplished in a series of steps , it is called as planning process. It starts from perception of opportunities to realisation of opportunities. It determines the future course of action for utilising resources

in the best possible manner to get optimum possible results. The various steps in planning process are described below:

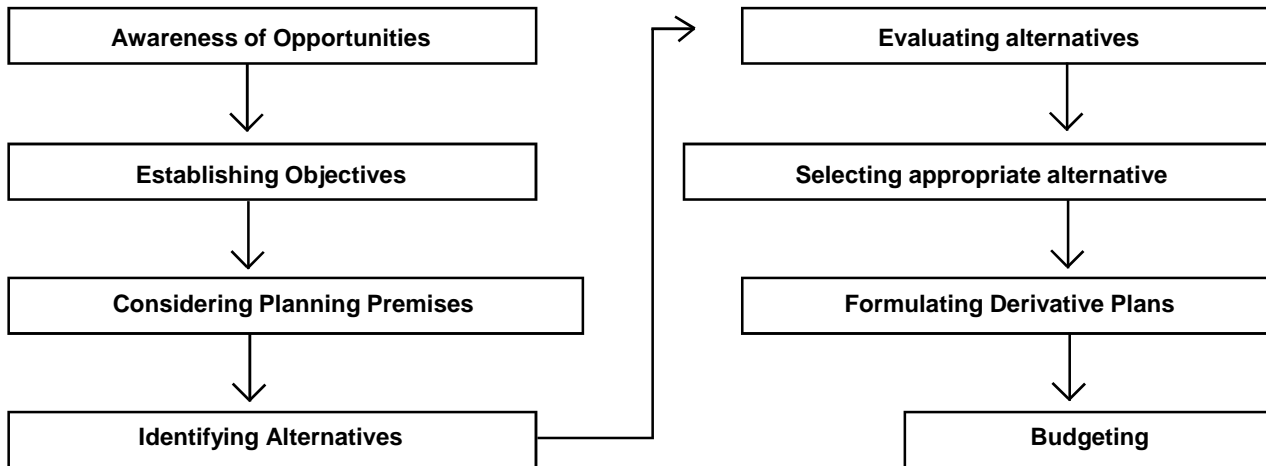

### Steps in Planning

**(i) Awareness of Opportunities :-** While planning, basically managers are needed to know the availability of opportunities to the organisation. Opportunities are available from environment. Opportunities for new projects can be had from changing needs of customers, technological changes, competitors weaknesses and innovative patterns of the organisation. Awareness of opportunities involves preliminary understanding and estimation of opportunities and analysing them in the light of strengths and weakness of the organisation for the purpose of assuming them. It enables the organisation to see objectives clearly in specific terms and makes the organisation to relate itself with the environment. When the managers are utilising the opportunities, it is to be observed they should be free from threats.

**(ii) Establishing Objectives :-** After assuming the opportunities, objectives are to be established in the organisation. The second step in planning is to set up objectives for the enterprise as a whole, and for the departments and individuals. Objectives are to be set for the long run as well as for the short run. Objectives are the end points for managerial course of action and they are the destination for all the activities. Objectives specify the expected results and show how the destination is to be achieved and where emphasis is to be placed.

Objectives of enterprise are to be translated into departmental objectives, and departmental objectives are to be converted into individual goals. Then only overall objectives for which the organisation is established can be achieved. Enterprise objectives give direction to major plans, in turn they are used to setup objectives for lower levels. Objectives appear in different forms, they are, mission, overall objectives, divisional objectives, departmental objectives and individual objectives etc.,

**(iii) Planning Premises :-** Once the objectives are determined, the next step is establishing the planning premises. Planning premises refer to the environmental, conditions or surrounding circumstances in which plans work. Plans will operate in future, hence it is appropriate to expect future conditions and should plan accordingly.

**(iv) Identifying the Alternatives:-** In order to achieve the objectives under expected conditions managers first must identify various alternative courses of action. For instance, to achieve the objectives of securing desired profits, necessary plant and machinery should be established in the organisation. The machinery can be of different types like manual plant. Semi-automatic plant and complete automatic plant. These are known as alternatives of a course action. No manager should satisfy with the least number of alternatives, he should strive to maximise the number of alternatives. But while developing the alternatives, organisational frame work like constraint of capital, manpower and philosophies may be taken into account.

**(v) Evaluating the Alternatives :-** After identifying the alternatives, the following stage is to evaluate their advantages and disadvantages. Their evaluation should be done in the light of the enterprise objectives. Every alternative has its own merits and demerits compare to others. For example, a manual plant may appear better, because of low investment. But when the volume of operations increase, workers will increase, as a result problems like, strikes, lockouts and production disorders may enhance. Moreover, there is no certainty about the outcome of a specific alternative clearly, because it is related to future and future is unpredictable and unimaginable.

**(vi) Selecting a Course of Action :-** Choice of a particular alternative is the next step after evaluation. Evaluation explains the merits and demerits of alternatives. Selection is the real point of decision making. Selection of a particular alternative is to be done to achieve the objective. At many times, it is confirmed that selection of two or more alternatives is better than choosing only one alternative. Hence, managers should plan in such a manner to select right combination.

**(vii) Formulating Derivative Plans :-** After designing the master plan for the total organisation, it is necessary to draw plans for various departments separately. These departmental plans are known as Derivative Plans. For instance, in order to generate desired profits for the organisation, production department should have production plans regarding number and quality of units to be produced, finance department should have financial plan regarding the magnitude and sources of resources, personnel department is needed to sketch personnel plan regarding selection and training of people, so on so forth.

**(viii) Budgeting :-** A budget is forecasted statement of revenue and expenditure, it is a numberised plan. It allocates the various resources to the required activities keeping in view of objectives. In fact, it materialises the objectives and implements the plans. No plan will be implemented, unless it is supported by adequate

resources. The organisation and each department working in it can have their own budgets. Hence, budgeting, that is, the allocation of resources is the last stage of planning which puts the plan into action.

The planning sequence discussed above, is almost similar to all the managers but may differ according to the complexity and time duration of plans like some steps may be prolonged and some stages may be shortened. But the fact is, often some managers do not spend even a little bit of attention, to formulate mega plans and then, undoubtedly it may lead to disastrous consequences. Further, planning must be cost-effective. That means it should satisfy the costs that incur in the process of planning. For example, the time and money a manager will spend to acquire plant and machinery worth crores of rupees must be higher. He should not give the same efforts to purchase a typewriter. Otherwise it will be unproductive and wasteful. Hence, proper planning should be done keeping in view the circumstance, the need, the magnitude and level of commitment.

**4.3. Features of a Good Plan :-** People, organisations and nations plan their activities, in fact planning is a part of life for everybody. Lyndall Urwick has stated the characteristics of a good plan as follows :

(i) Clear Objectives - A plan should consist of clearly defined objectives including corporate, departmental or functional and individual objectives.

(ii) Simple and Easy - A good plan must be simple and easy to understand, otherwise several operational problems will arise especially at lower levels of complex plan seldom achieves the objectives.

(iii) Comprehensive - Plan should be as much comprehensive as possible. It should touch all concerned functions.

(iv) Flexible and Adaptable - Plan operates in future time periods. Future conditions are predictable accurately to some extent. Hence, whenever certain extraordinary situations crop up, plan should be changeable accordingly. Otherwise the very purpose of planning suffers.

(v) Utilization of Resources - Proper planning ensures optimum utilisation of human and financial resources. Utilisation should be neither more than reasonable nor lesser.

(vi) Feasible and Reasonable - A good plan must set fair and reasonable objectives otherwise it demoralises the performance of subordinates.

(vii) Communication of Planning Elements - It is highly desirable that the various aspects of planning should be communicated properly to different levels of manager.

(viii) Open Systems Approach - To make planning effective, managers must create an environment in which subordinates can freely exchange their opinions, feelings and problems with superiors. The interfaces and interactions of plans with every element of environmental conditions and influences can be exact.

(ix) Integration of Long-term and Short-term plans - Long-term and short-term plans should go hand by hand to create synergical effect. Short range plans must be developed keep in view the long range objectives of the organisation. In the same way, while formulating long-term plans, operational and other short-term problems are needed to give due consideration to the reasonable extent. Hence, proper coordination is essential between them for smooth performance. of the organisation.

#### 4.4. ADVANTAGES OF PLANNING :

**(i) Planning increases the organisations ability to adopt to future eventualities :-** The future is generally uncertain and things are likely to change with the passage of time. The planning activity provides a systematic approach to the consideration of such future uncertainties and eventualities.

**(ii) Planning helps to crystallise objectives :-** The first step in planning is to fix objectives which will give direction to the activities to be performed. This step focusses attention on the results desired. It also enables to identify future problems.

**(iii) Planning ensures a relatedness among decisions :-** Relationship among various decisions take managers to the achievement of the goals or objectives of enterprise.

**(iv) Planning helps the company to remain more competitive in its industry :-** Planning may suggest the addition of a new line of products and changes in the methods of operation for a better identification of customer needs and expansion of plant capacity. All these render the company to meet the competition.

**(v) Planning reduces mistakes and oversight :-** Though mistakes can not be eliminated completely. They can be reduced through proper planning.

**(vi) Reduces unnecessary pressures :-** Adequate planning supplies orderliness and avoids unnecessary pressures.

**(vii) Ensures more productive use of organisations resoures :-** Planning results in greater productivity through a better utilisation of the resources available to the organisation without wastage in money, men and machinery.

**(viii) Makes control easier :-** The crystallisation of objectives highlight the controls required.

**(ix) Planning can help the organisation secure a better position or standing :-** Adequate planning stimulate improvements in terms of opportunities and utilisation of opportunities with better means.

#### 4.5. LIMITATIONS OF PLANNING :

Planning as a management function is essential to every manager and every organisation. But there are some practical problems in proper planning. Managers can do better if they are aware of these limitations so



that they can take adequate precautions against them. The major limitations to effective planning are given below.

**(i) Difficulty of accurate premising :-** Planning is based on forecasts which are never cent percent accurate. Accurate premising is not possible as future can not be predicted with complete accuracy. The accuracy and reliability of plan depends upon the data on which it is based. The accuracy and reliability of forecasts diminishes as the forecasting period increases. An efficient system of forecasts and research is essential for accurate planning.

**(ii) Problems of Rapid change :-** Another problem which is related to the external environment is the rapid change which takes place in the environment. In a rapidly changing environment, planning activities taken in one period may not be relevant for another period because the conditions in two periods are quite different.

**(iii) Internal Limitations :-** Managers while going through the planning process have to work in a set of given variables. These variables often provide less flexibility in planning which is needed to cope up with the changes in future events. Such limitations may be either internal or external to the organisation.

**(iv) Psychological limitations :-** Managers and employees in the organisation may develop rigid patterns of thoughts and behaviour which are hard to change. They look more interms of present rather than future. For them this approach works against planning because planning often depends on changes.

**(v) Policy and procedural limitations :-** Another internal limitation emerges because of organisational policies and procedures. Once these are established, they are difficult to change through these policies are meant for managerial actions, they often leave little scope for managerial initiative and flexibility. Since managers have to plan for future which is not static but changing, they often find themselves in great constraints.

**(vi) Lack of Rewards :-** Managerial rewards are quite often interlinked to short term results and their performance. So they tend to pay attention to immediate, pressing problems rather than waste their energies on long range plan.

**(vii) Lack of Participation :-** People who are not involved in planning tend to resist the planning process. Planning imposed from higher authorities often leads to resentment and resistance among those forced and execute.

**(viii) Lack of Specific Objectives :-** Often qualitative objectives like social responsibility, management, development, quality work life etc., are expressed in vague generalisation which defy proper evaluation. Planning can not be effective unless goals are specific, clear and actionable.

**4.6. Making Planning Effective :-** The following principles can be applied to increase effectiveness in planning.

**(a) The commitment principle :-** Planning includes comitment of resources in a specified direction. Especially, in the case of long-range planning, long-term decisions and implication are involved. A decision is a commitment or funds, direction of action or reputation. Planning is futuristic whereas decisions are to made today.

**(b) Principle of Flexibility :-** Flexibility is essential to make planning successful because it will lessen the danger of losses incurred through unexpected events. But the cost of flexibility should be weighted against its benefits.

**(c) Principle of Navigational Change :-** It is necessary to check the plans periodically and redraw plans. Because some times the conditions so change and makes the existing plans ineffective. It is compared to the role of a navigator who changes the direction of ship according to ocean currents and winds.

**(d) Principle of Limiting Factor :-** In choosing among alternatives, managers must recognise and solve the factors which are limiting and hindering the achievement of objectives, like constraint of finance and technology, etc.,

#### 4.7 TYPES OF PLANS :

In order to make planning effective, managers need to know the existence of different types of plans. Some times, managers fail to recognise the variety of plans, as a result face certain problems. Managers may consider a major programme like construction of a building or purchase of a plant as plan. Planning brings several individual plans and derivative plans which should operate in a specific direction. Some of these plans are standing plans, it means once they are formulated they will be used for a long period and repeatedly like strategies, objectives and policies. Whereas, there are also single-use plans, as the name indicates such plans can only be used once afterwards again they are to be formulated like targets and budgets. Further, a number of other courses of action are also plans. Hence, it is necessary to distinguish one type of plan with other types of plan for proper application and managerial action. They are depicted below :

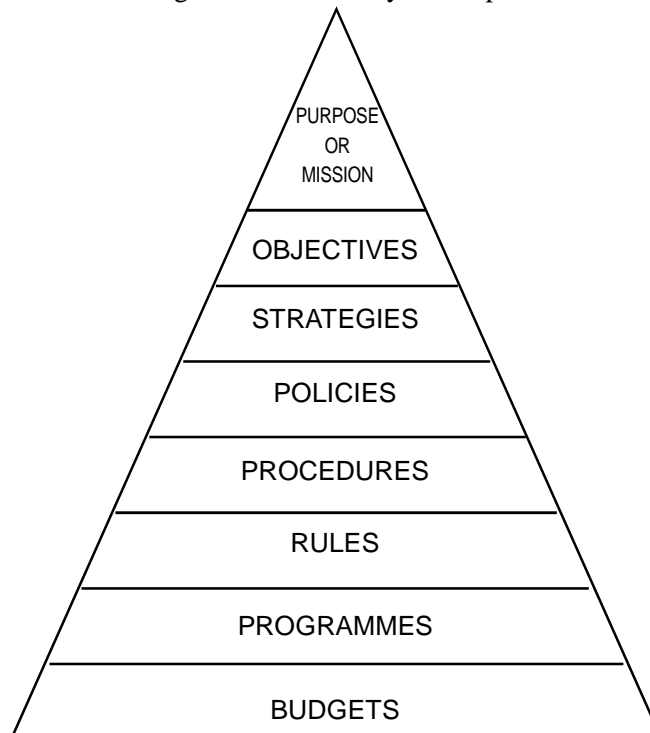

As shown above they are various types of plans like purpose or mission, objectives, strategies, policies, procedures, rules, programmes and budgets. These are arranged in a hierarchical form because a higher level plan gives rise to or generates a lower level plan. They are described as follows:

**4.7.1. Purpose or Mission :-** It is a standing plan in the sense that it defines the basic intention or function or the reason for which the organisation is started. Depending upon the purpose other activities are designed. The existence of an organisation is to satisfy certain socio-economic means otherwise it has no reason to exist. For example, Bajaj exists to serve the transportation needs of the society, Tata Steel is to aid in nation building, even ITC exists to satisfy recreation needs of the people. Anti-social organisations like narcotics which endanger the interests of the society cannot exist for long.

The mission of an organisation contains long-term mission of what it seeks to do and the reason why it exists. Every kind of organisation has or should have meaningful purpose or mission. Hence, Drucker quotes, "To know what a business we have to start with the purpose. Its purpose must lie outside the business itself. In fact, it must lie in society since business enterprise is an organ of the society. There is only one valid definition of business purpose - to create a customer. "The purpose describes the business character if the organisation and does so in ways that tend to distinguish it from other organisations. The purpose or mission can be observed from the mission statement of the organisation such as ITC states "New Horizons, New Hopes" H.M.T. quotes "Time Keepers of the nation".

Some management writers distinguish between purpose and mission. According to them, the social purpose of an organisation is to produce and market goods and services, whereas the mission is producing certain product lines. For example, the purpose of Bajaj is to satisfy the transportation needs of the society, while the mission is to produce and distribute two and three wheelers. However, in practice such difference is not observed much.

**4.7.2. OBJECTIVES :-** Objectives are to be drawn keeping in view the purpose of an organisation, in fact objectives are the means to achieve the purpose, objectives or goals toward which activities are aimed. Objectives show the results to be achieved. They represent not only the end point of planning but the end towards which organising, staffing, leading and controlling are aimed. Corporate objectives are drawn from the mission of the organisation, they can be translated into departmental objectives like production, marketing, finance etc., individual objectives emanate from departmental objectives. To be effective objectives must be as much quantitative as possible. Objectives are arranged in hierarchical form, viz, socio-economic purpose, mission, overall objectives, specific organisational objectives, divisional objectives, departmental or unit objectives and individual objectives.

Hence, Dalton Mc. Forland defines, "Objectives are the goals, aims or purposes that organisations wish to achieve over varying periods of time".

Terry states, "A managerial objective is the intended goal which prescribes definite scope and suggests direction to the efforts of a manager. "

Objectives may be broad like corporate goals or specific like unit or individual goals. They may be set either for long term or for the short term objectives may be clearly defined or those may not be clear which have to be interpreted. Organisations may have multiple objectives, especially it is true in the case of public sector organisations like social service, employment, customer service and profitability. But according to Koontz, "the objectives of any manager are productivity, efficiency and effectiveness."

**4.7.3. STRATEGIES :-** Strategy is a plan of action. They are complex plans for bringing an organisation from a given posture to a desired position in the future period. Strategy is basically a military concept, it is used in competitive implication in business. Strategy is delivered from the Greek word 'Strategos' which means general, it refers to the art of general. Strategy is described by Anthony as, "The programme of objectives of an organisation and their change", resources used to attain these objectives and policies governing the acquisition and disposition of these resources.

Alfred D. Chandler has more clearly defined as "Strategy is the determination of the basic long-term objectives of an enterprise and the adoption of courses of action and allocation of resources necessary to achieve these goals.

The purpose of strategies is to determine and communicate major objectives and policies systematically. Strategy outlines a frame work for several programmes, major and minor. Planning may be similar in all the organisations, whereas strategies are different from one organisation to another like Hindustan Lever may follow Push strategy, and Procter and Gamble may adopt Pull strategy. A strategy is basically a long term plan, it will have long term implication.

#### **4.7.4 POLICY :**

Policies will be formulated depending upon the strategies of the organisation. Policies are the guidelines for the managerial decision-making. They are also plans which are general statements and understandings which guide or channel thinking in decision making. Policies define an area within which a decision is to be made to ensure that the decision will be consistent with the objectives. Eventhough policies need to be consistent, they can be made flexible and can be released using managerial discretion. Otherwise, they will become rules. For example, the organisation may have the policy like sanctioning fifteen days leave to employees. But in the cae of health hazards or accidents, the manager may extend the leave beyond the stipulated period.

Formulation of clear policies in all the areas, eases the job of manager, improve clarity in the organisation, brings stability and objectivity in employee relations and makes the managers to think more attentively and particularly regarding policy exceptions, i.e., in which policies are not determined.

Policies appear in all the fields of organisation, viz., the production manager have certain policies regarding procurement of raw materials and purchases, the finance manager design guidelines regarding debt-equity ratio and sources of working capital, the personnel manager determine the methodology concerning working policies regarding promotion expenditure and media selection.

Further, policies usually exist in all levels of the organisation, ranging in major corporate policies to minor individual level. Policy is a means of encouraging discretion and initiative, but within the limits. However, the amount of discretion and freedom depend upon the nature of policy and managerial level in the organisation.

**Principles of Policy Making :** For sound and efficient policy making the following principles are to be remembered.

- ☞ ***Clear and Positive*** :- The policy should be clearly and easily understandable to everyone concerned. Similarly a positive and definite policy would prevent unnecessary delays and involuntary deviations from accepted courses of action.
- ☞ ***Reasonable and Stable*** :- The policies formed should be stable and reasonable to avoid uncertainty and indecision in the minds of those who seek guidance from them. A stable and permanent policy helps in forward planning of operations.
- ☞ ***Based on sound judgement*** :- The policy statements should always spring from sound judgement but not out of personal preferences or reflections.
- ☞ ***Avoid detailed procedures*** :- As policies are intended to be general principles to guide future actions, they should not prescribe lengthy procedures.
- ☞ ***Effectively Communicated*** :- The mere framing of policies is not of much use unless they are properly communicated to every one concerned in a clear and unambiguous manner.
- ☞ ***Reflect the objectives*** :- The policy statement must reflect the basic objectives of the undertaking and in no way contradictive to the predetermined objectives of the concern.
- ☞ ***Subject to evaluation and modification*** :- The framed policies must be reviewed and evaluated from time to time so that changes or innovations needed may be immediately incorporated.

***In Writing*** :- Policies should, as far as possible, be stated in writing.

**4.7.5 PROCEDURE** :- Procedures establish a required method of handling future activity. They are guidelines to action and they detail the exact manner in which certain activities must be accomplished. In other words, they state the specific manner in which a particular activity is to be performed. Fundamentally, they state the chronological sequences of the action to achieve an objective.

Terry defines a procedure as, "A procedure is a series of related tasks that make up the chronological sequence and the established way of performing the work to be accomplished."

Procedures include how each task in the organisation will take place. When it will take place and by whom it is to be performed. Usually, time limits are also placed on each step of a procedure to ensure that the

end result can be attained as deemed. Once the procedure is established, it can be used over and over for attaining a specific task. In a company, procedures can be established for several or all activities. They are very much pervasive and cover the entire organisation. For example, the procedure may be established regarding the manner of decision-making by board of directors or how a leave can be applied and or how a bill can be encashed or the reporting system in the organisation.

However, there is a difference between the procedure applied to different levels of the organisation. Normally, the procedure applied to lower levels in organisations is more rigorous than that is applied to higher levels. Because at lower levels, more routine jobs are performed requiring less discretion in decision-making. Procedures may come across the departmental or functional lines. Several times, the execution of a work may require the help of various departments even at lower levels also. For instance, in a manufacturing organisation the procedure for handling orders involve the sales department (the original order taker), the finance department (for receiving cash or sanctioning credit), the accounting department (for recording the transaction), the production department (for the order to produce the goods) and the shipping department (for the delivery of goods).

Policies and procedures are very much interrelated. There should be a clear procedure for implementing the policies. In other words, policies should be supported with good procedure. A good procedure is one which is not cumbersome and provoke red tapism. It should be stable, flexible, modern and minimum length.

**4.7.6. RULES :-** Rules specify the required course of action to do and not to do, there is no discretion for obliging them. They are simple plans. Rules are prescribed guides for conduct or action. They are established authoritatively, and utilised in order to perform conditions as designed. There are so many areas where rules can be imposed., like Office opens at 10 A.M., No Smoking and Sunday is Holiday, etc.,

Rules are different from policies and procedures. A policy provides guidelines for managerial decision by defining areas of discretion, whereas rules provide yardsticks for actions without discretion and exemption. Rules do not allow any deviation from stated course of action and in no way it interferes with the rest of the procedure. Further, rules are unlike procedures in which they guide action without specifying any time sequence. Actually, a procedure might be looked upon as a sequence of rules. The essence of a rule is that it reflects a managerial decision that certain action must or must not be taken.

**4.7.7 PROGRAMMES :-** A programme is a set of activities consisting of goals, policies, procedures, rules and task assignment necessary to carry out a given course of action. It includes employment of resources and other elements supported by budgets. A programme or project can be defined as "a type of plan which can be thought of in terms of planned actions integrated into a unity and designed to bring about a stated objective." It is a scheme for investing resources which can be analysed and appraised independently. A project involves basically the investment of funds at present and the benefits can be secured in future. A project may be a gigantic programme like setting up a huge plant and machinery, or purchasing a typewriter.

A primary programme contains many supporting programmes. For example, in order to establish a major plant, along with purchase of costly equipment and buildings, minor programmes like installation and maintenance are to be chalded out. Moreover, all these programmes call for coordination and timing. If any delay or failure occurs in minor programmes, it causes failure or incurs delay and heavy costs to the major programme. Project activity is definable in terms of specific objectives. It is critical to the organisation in terms of realisation of its objectives. Hence, the completion of project at right time and with appropriate cost is necessary.

**4.7.8 BUDGETS :-** A budget is a numberised plan. It is a forecasted statement of revenue and expenditure. Therefore, budget can be stated as, "a plan of expected results expressed in numerical terms." It describes organisational and departmental objectives and programmes in financial and non-financial quantities. It anticipates operating results over some future period, usually for one year, and provides a basis for measuring performance.

The budgets can be prepared for various activities. Through the budget revenue can be expected, and resources can be allocated to various heads. It enables the performance and accomplishment of stipulated activities in planning. Infact, the budget materialises the planned activities. For example, the budget of central government measures the revenue and allocates the resources for various heads such as defence, agriculture, education and power, etc.,

The organisation prepares a master budget and several derivative budgets. A master budget is a comprehensive budget covers the whole organisation. Whereas, derivative budgets are the supporting plans prepared for the departments and units. For instance, a budget may be expressed either in financial terms or in terms of working hours, units of production, machine-hours, etc., It may be a capital budget, operational budget or cash budget. Whatever, it may be, it provides guidelines for action and also standards for control.

#### **4.8. MANAGEMENT BY OBJECTIVES (M.B.O.) :**

Peter F. Drucker has pioneered the concept of MBO. According to him, Objectives are the ends and means of an enterprise, all the activities must be framed and directed to perform objectives and no deviations from the achievement of objectives is permitted. There should be a great concern and commitment towards objectives throughout the organisation at any level, then only organisations can survive. It means organisations are to be managed in such a way to achieve the objectives. Hence, MBO should be both the philosophy and approach of management. The concept has gained immense popularity all over the world.

**Meaning and Concept of MBO :-** MBO is an interactive process in which both superior and subordinates jointly identify and determine the common objectives, evaluate the performance and implement the necessary recycling. It also integrates individuals with organisation for effective utilization of resources. Hence, S.K. Chakraborty quotes, "MBO is a result-oriented, non-specialist, operational managerial process for the effective utilisation of material, physical and human resources of the organisation by integrating the individual with the

organisation, and the organisation with the environment." It means MBO is an overall programme and permits participation among concerned groups to bring results with appropriate use of resources.

Koontz and O'Donnel opined, "MBO is a comprehensive managerial system that integrates many key managerial activities in a systematic manner, consciously directed towards the effective and efficient achievement of organisational objectives." It emphasises the significance and operation of MBO for attainment of goals.

**MBO process :-** The process of MBO translates organisational objectives into individual objectives with the commitment and participation of employees. It improves the clarity and balance of the objectives and makes rigorous analysis throughout the organisation. The process is described below.

**(a) Establishment of Organisational Objectives :**

Basically organisational objectives are to be formulated with the interaction of planning premises. Planning Premises refer to the environment in which future plans will operate. The manager has to assume the future environment and should set the objectives accordingly. The objectives must be made clear as long term and short term objectives, and corporate and departmental objectives.

**(b) Identification of Key Result Areas (KRAs):-** Key Result Areas refer to departments or divisions or elements or functions of an enterprise which play a vital role in the achievement of stated objectives. They are to be identified keeping in view planning premises and corporate objectives. For eg., in the present era of globalisation, the major thrust of many Indian enterprises is improvement of quality standards, so R & D can be identified as KRA .

The KRAs are not constant, they vary periodically according to changing conditions and demands. They also change from organisation to organisation, depending on its philosophies and characteristics.

**(c) Determination of subordinate's objectives :-** Corporate objectives are to be translated into superior's objectives after designing an appropriate organisation with required authority and responsibility. Then superior attempts to decide subordinate's objectives with the participation of concerned subordinate. Because the basic concepts of MBO are interaction and mutual acceptance, which increase commitment towards achievement of objectives.

**(d) Performance Evaluation and New Inputs :** - After establishing the goals of subordinate's, their performance can be reviewed periodically by the superiors, and necessary corrective measures and assistance may be provided by the superiors, like the suggestions, quality maintenance, etc., Further, new inputs like training and developments, incentives, additional facilities and infrastructure can be furnished in order to see that the final performance must match the objective standards.



(e) **Recycling** : - Eventhough, performance is the final stage of MBO process, it is used as an input for recycling objectives and other pertinent activities. In the MBO process, since all the stages are inter-related, the outcome of appraisal at one level is recycled to the higher level to see that objectives are to be performed. For example, when subordinate's objectives are changed after the consultation, then superior's objectives are to be redrafted, i.e., either increased or decreased to match subordinate's objectives. Or the organisation structure is to be changed.

### **Advantages of MBO**

- (i) Better management ;
- (ii) Clarified organisation structure;
- (iii) Willingness and commitment of people;
- (iv) Mutual interaction and open system approach;
- (v) Development of effective controls;

### **4.9 MANAGEMENT BY EXCEPTIONS (MBE):**

Management By Exceptions is a significant principle of organisational control. According to MBE, only important deviations, i.e., exceptions, from standards of performance should be brought to the management's attention. It means, minor deviations must be permitted. and need not be reported to the manager concerned as far as actual performance coincides with the planned objectives. But when there is a major deviation from planning it should be brought to the notice of the manager. Then the manager can take stern actions to rectify such deviations.

MBE is devised to conserve managerial time and effort on unimportant issues, and the managers can use their efforts more productively for the organisational development. MBE is also a technique of separating vital information from useless information. In this regard, only such information which is important for management control actions is to be sent to top management. It facilitates the establishment of effective control system. As per MBE , the management should be selective in using control. It should choose key areas whose performance effects the total organisations. These key areas also change from time to time. However, MBE ignores minor mistakes which seldom may be more costly.

### **4.10 CRISIS MANAGEMENT :**

Organisations face crisis several times. Crisis may be referred as a difficult situation, which arises out of improper planning or failure of planning mechanism. Often, crisis is abrupt and occurs due to mismanagement of financial and human resources. Hence, managers are required to formulate specific and fast strategies and

methods to overcome such peculiar situations. So, crisis management is defined as, "the technique of managing or facing crisis situations." It is also stated as taking decisions or finding solutions for crisis situations.

In organisations, crisis situations may emerge when proper decisions have to be taken immediately to rectify a course of action or to replenish shortage of resources. Crisis arises when things do not move in the desired direction or when things do not occur according to one's expectations.

#### **Methodology :**

The following methodology is suggested to manage and cope up with crisis situations effectively.

- (a) The crisis manager should maintain calm and cool temperament in such situations.
- (b) He should not take any sides, like pro-management or anti-management.
- (c) He should gather background information before finding a solution to the problem.
- (d) He should consult the various parties who are involved and may throw light on the problem.
- (e) He should identify the real problem and peripheral problems.
- (f) Crisis may not be solved with one solution at one step. Often stage-wise and department-wise decisions are to be taken.
- (g) Crisis Manager should take clear and distinct decisions suitable to the situations.

However, decision making must be fast enough otherwise the very purpose of crisis management collapses. It is commonly understood that crisis management is more an art than a science.

#### **4.11. SUMMARY :**

In this lesson it is attempted to elucidate the planning process and features of a good plan. Often the types of plans are overlapping, hence, the various types of plans are properly distinguished. Further, MBO process is described to highlight the achievement of objectives. Management By Exceptions and Crisis Management are also discussed to establish effective managerial systems in the organisations.

#### **4.12. KEY WORDS :**

- 1. Planning :** It is the determination of future course of action. It is thinking before doing.
- 2. Master Plan :** It is the overall plan of a company, coordinating various departmental or functional plans.
- 3. Flexibility :** Ability to change according to changing conditions, otherwise plans become ineffective.

**4.13. SELF ASSESSMENT QUESTIONS:**

1. Define planning. Explain the steps involved in the planning process.
2. Distinguish between the following
  - (a) Strategies and policies
  - (b) Programmes and procedures.
3. Write short notes on Management By Exception (MBE)
4. What is meant by MBO? State its process and advantages.
5. Explain the concept and significance of crisis management.

**4.14. FURTHER READINGS :**

- \* Dalton E. Mc Farland, "Management Principles and Practices, " Mc Millan, 1974.
- \* Stoner A. James, "Management", Prentice Hall of India, New Delhi, 1994.
- \* Newman , William ,Charles E. and Warren, E. Kirby, "The Process of Management :Concepts, Behaviour and Practice, " Prentice-Hall of India, 1974.

**Y V S Prasada Rao**

## Lesson - 5

# PLANNING PREMISES

**Objectives :** After you have completed this lesson, you should be able to :

- ☛ understand premises, types of premises.
- ☛ know the role of premising in planning
- ☛ trace the importance of decision making
- ☛ clearly understand decision making process
- ☛ know the role of group decision making and limitations
- ☛ understand the decision making and rationality
- ☛ identify the phases of decision making and need for models
- ☛ understand some decision making techniques

### Structure

- 5.1 Introduction
- 5.2 Types of Premises
- 5.3 Decision Making Process - steps
- 5.4 Decision Making - Importance
- 5.5 Group Decision Making
- 5.6 Decision Making and Rationality
- 5.7 Systems Approach and Decision Making
- 5.8 Decision Making Techniques
  - (A) Decision Tree Analysis.
  - (B) Linear programming
  - (C) Game Theory
- 5.9 Summary
- 5.10 Self Assessment Questions
- 5.11 Further Readings

### 5.1 Introduction :

Planning premises are the anticipated environment in which plans are expected to operate. They include assumptions or forecasts of the future and known conditions that will affect the operation of plans.

#### Forecasts that are planning Premises

Examples : Determining future business condition sales volume, or political environment furnishes premises on which to develop plans

#### Forecasts that are translated into future expectancies

Forecast of costs or revenues from a new project translates planning programme into future expectation

Premising is the formal recognition that managing is an open-system approach to organised activities. It is not enough to be responsive to the present environment. There are short-and-long range economic, technological, social, political changes that will affect the business. The manager needs to examine what will or can be done in future.

### 5.2. Types of Premises :-

Planning premises may be classified as follows :

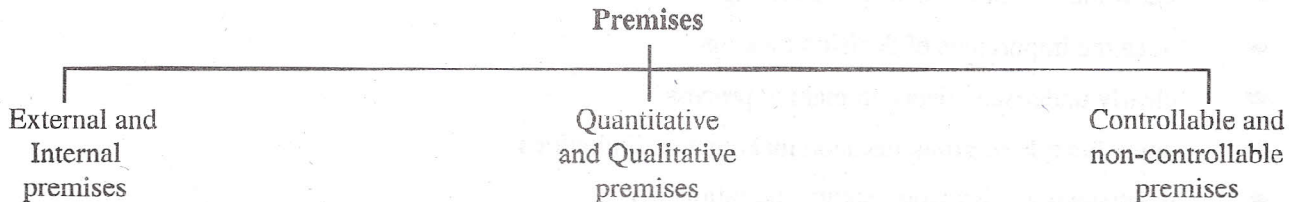

(a) **External Premises** : Premises that relate to external environment are called external premises. External premises include

- a) **General environment** : which includes economic, technological, political, social, legal and ethical conditions.
- b) **Product Market** : The conditions influencing demand for product and services offered by the firm.
- c) **Factor Market** : The firm has to forecast the issues like the availability of land, location, labour supply, Raw material, other material etc.,

(b) **Internal premises** : These relate to the events occurring within the organisation like basic policies and programmes, sales forecasts and organisation structure.

(c) **Quantitative premises** : The forecasts when put in terms of Rupees (money terms) are called Quantitative premises.

(d) **Qualitative premises** : Certain issues like political stability, prestige in a product line, Emotional impact of certain personnel policy etc. which cannot be Quantified.

(e) **Controllable premises** : Certain issues like whether to expand, diversify etc., are more or less controllable.

(f) **Non - Controllable premises** : Population growth, shifts in population, political environment, are more or less non controllable.

There are semi controllable premises like planning for market share, pricing policy and strategy etc.,

**Activity / Assignment** : Workout a planning premises for a Corporate hospital to be opened by you in your city/ town. What are the external and internal premises.

**5.3. Decision Making Process - Steps** : Decision making signifies actual selection of a course of action from among a number of alternatives. It is so important to the job of managing that management is sometimes described as consisting of the whole process of decision - making. Decision making permeates planning, organising, controlling, and all other functions of management. Because of limitations in time, money etc. Management is forced to discover a number of alternatives and choose that alternative which is expected to contribute more with less costs and other unintended consequences to the accomplishment of same goal. Since decision-making involves selection from among alternatives the course of action to be followed, it is better regarded as part of planning process.



Management has to take decisions on all types of problems and matters. It will however be better if decisions relating to routine matters are passed as down the levels of organisation so that top management can concentrate as vital and strategic decisions and laying down broad policies. It will also add to efficiency of management if decisions relating to distant future are made in advance. However, it needs to be emphasised that decision-making as a rational process should be based upon systematic analysis of all pertinent facts and not guided by intuition or hunch.

A manager is responsible for making decision on matters falling within the scope of his authority and normally decisions which can be taken at a given level should not be referred to upward. A manager should skillfully use his intelligence while deciding a problem because Quality of decisions made by him indicates the extent of responsibility discharged. Steps in decision making are as follows.

**5.3.1. Identification and diagnosis of the problem :** Understanding the situation that sets the stage for present decision-making by a manager is an important element in decision-making. Pre-determined objectives, past acts and decision, and environmental considerations provide the structure of for current decisions. Once this structure is laid, the manager can proceed to identify and determine the real problem.

Diagnosing the real problem implies knowing the gap between what is and what is expected to happen, identifying the reasons for the gap, and understanding the problem in relation to higher objectives of the organisation. However, sometimes symptoms are mistaken for real problem. Defining the problem is thus not an easy task. It is said that a well defined problem is half solved.

**5.3.2. Developing Alternatives :** The next step is to search for available alternatives and assess their probable consequences. But the number of forces reacting upon a given situation is so large and varied that management would be wise to follow the principle of the limiting factor. That is, management should limit itself to the identification of those key factors which are critical or strategic to the decision involved.

Identification of the limiting factors is so important to the process of decision making that sometimes is described as search for the strategic factors. But search for the limiting factors is by no means easy and managers must use judgement. However, in any attempt to identify the strategic factors management should not lose sight of higher objectives of the organisation and analyse limiting factors in terms of their contribution to the accomplishment of organisational objectives.

**5.3.3. Analysis and evaluation of available alternatives :** Once the alternatives are developed the next stage is to analyse and compare their relative importance. This calls for listing of the pros and cons of different alternatives in relation to each other. Both tangible and intangible factors should be considered while evaluating different alternatives. Tangible factors like profits, time, money and rate of return as capital investment can be expressed numerically. Since these factors are analysed for the future, their evaluation is based as forecasts and estimates.

However intangible factors like public relations, reputation, employee morale and personnel relations prove significant and cannot be ignored in spite of difficulties to express them numerically. The analyst should, therefore, identify the relevant intangible factors and ascertain their relative importance to arrive at a judicious decision.

**5.3.4. Selection of the Best alternative :** Defining the problem, identifying the alternatives and their analysis and evaluation set the stage for the manager to determine the best solution. Here the manager is frequently guided by his past experience. Changes in the circumstances, and underlying assumptions of decisions in the past should be carefully examined before deciding a problem on the basis of experience.



It is sometimes argued that managers should draw conclusions on the basis of experiments. But it has the limitation of being the most expensive of the techniques and as such is generally recommended for use only when all other bases have been tried.

Another Useful basis for decision is the application of scientific method to planning & decision making. Application of research techniques helps the manager to visualise the problem and causal relationship between different variables in mathematical terms. In the recent past, more research has been carried out in the field of management in relation to the study and theory of decision making.

**5.3.5. Communication of decision and its acceptance by the organisation :** Once the decision is made it needs to be implemented. This calls for laying down derivative plans and their communication to all those responsible for indicating actions on them. It will be better if the manager takes into account beliefs and attitudes and prejudices of people in the organisation and also aware of his own contribution to implementation of the decision. It is further required that subordinates are encouraged to participate in decision-making process so that they feel committed and morally bound to support the decision. At the same time management should establish effective control so that major deviations can be observed, analysed and incorporated in future decisions.

**5.4. Decision Making - Importance :** Managers see decision making as their core job because they must constantly choose what is to be done, who is to do it, and when, where and occasionally even how it will be done. Planning and analyses are useless without right decisions. Hence decision making is key step in planning.

**Decision making is the selection from among the alternatives of a Course of action and this is at the core of planning :** A plan cannot be said to exist unless a decision on commitment of resources has been made.

Decision in the organisation are either Strategic or Tactical decisions.

Strategic decision are major choices of actions concerning allocation of resources and contribution to the achievement of organisational objectives.

Tactical or operational decisions are derived out of strategic decisions. These relate to day to day working of the organisation and are made in the context of well-set policies and procedures.

### **5.5. Group Decision Making :**

Decision-making by groups is not a rare thing to observe in business operations. Board meetings, committees, staff meetings, conferences, provide examples of decision - making by groups. Thus, directors at the top of an organisation make decisions in their Board meetings. Similarly, departmental managers or executives solve a number of problems jointly.

It what type of problems, at what level, and how, decision - making by group may be used in the organisation is a policy matter and rests with higher ups. But whenever it is resorted to, the appointing authority should lay down in explicit terms the scope and exact functions expected of the group.

**5.5.1. Group Decision Making - Advantages :** If properly handled, decision - making by groups or committees offers the following advantages.

- (i) It improves quality of the decision since different view points and opinions are reflected in it.
- (ii) Coordination of departmental activities through meetings of their respective heads become easier.

(iii) Group decision - making provides opportunity for participation by individuals representing different interests and thus improve their morale and motivate them for whole - hearted coopertion in carrying out the decisions.

(iv) It provides opportunity for training of employees and their development.

**5.5.2. Limitations :** However, group decision making is not free from limitations. The important weaknesses may be enumerated as follows.

(i) It is costly as well as a time - consuming affair and as such, cannot be recommended particularly in situations where decisions must be made promptly.

(ii) More often differences in opinion and compromises lead to indecision.

(iii) It is also observed that group decisions help members evading their individual responsibilities.

(iv) If an influential member of the group is able to dominate discussion in the meetings, decision so made does not represent synthesis of view points of different interests.

### 5.6. Decision Making and Rationality :

Effective decision making requires a rational selection of a course of action. But what is rationality? Certain conditions must be met before we can say that people are acting or deciding rationally.

i) They must be attempting to reach some goal that could not be attained without positive action.

ii) They must have a clear understanding of alternative courses by which a goal could be reached under existing circumstances and limitations.

iii) They must have the information and the ability to analyze and evaluate alternatives in the light of the goal sought.

iv) Finally, they must have a desire to come to the best solution by selecting the alternative that best satisfies goal achievement.

Complete rationality can seldom be achieved, particularly in the area of managing. What a manager must settle for is limited rationality, or what has been called "bounded" rationality. In view of the very great limits to being completely rational in practice, it is not surprising that managers sometimes allow their dislike of risk - the desire to "play it safe" - to interfere with the desire to reach the best solution. This was referred to by 'Herbert Simon' as "satisficing", picking a course of action that is satisfactory or "good enough" under the circumstances.

**5.7. System Approach and Decision Making :** Decisions cannot usually be made in a closed - system environment. As emphasized earlier in the unit on planning premises, many elements of the environment of planning lie outside the enterprise. In addition, every department or section of an enterprise is a subsystem of the entire enterprise; managers of these organisational units must be responsive to the policies and programmes of other organisation units and of the total enterprise. Moreover, people within the enterprise are a part of the social system, and their thinking and attitudes must be taken into account whenever a manager makes a decision.

### Assignments :-

**Assignment - 1 :** You are the CEO of Pioma Industries, which experienced a sudden fall in sales of their brand 'Rasna' (a soft drink concentrate). How do you proceed to evaluate and decide what to do?



**Assignment -2 :** You are the chairman of a task force to decide in the expansion programme embarked upon by your company. The task force contain all the important people from different departments. How do you plan to decide on what to do (concentrate on weaknesses in group decisions).

**5.8. Decision Making Techniques :**

Let us have a look at management models and the process of decision making. Decision making involves three phases - the "intelligence" stage of searching the environment calling for decision; "design" or finding and assessing the alternatives; and "Choice" or selecting one from among the many available alternatives. the first phase calls for defining the problem. The second involves search for alternatives and their evaluation. The final phase selects the desired alternative.

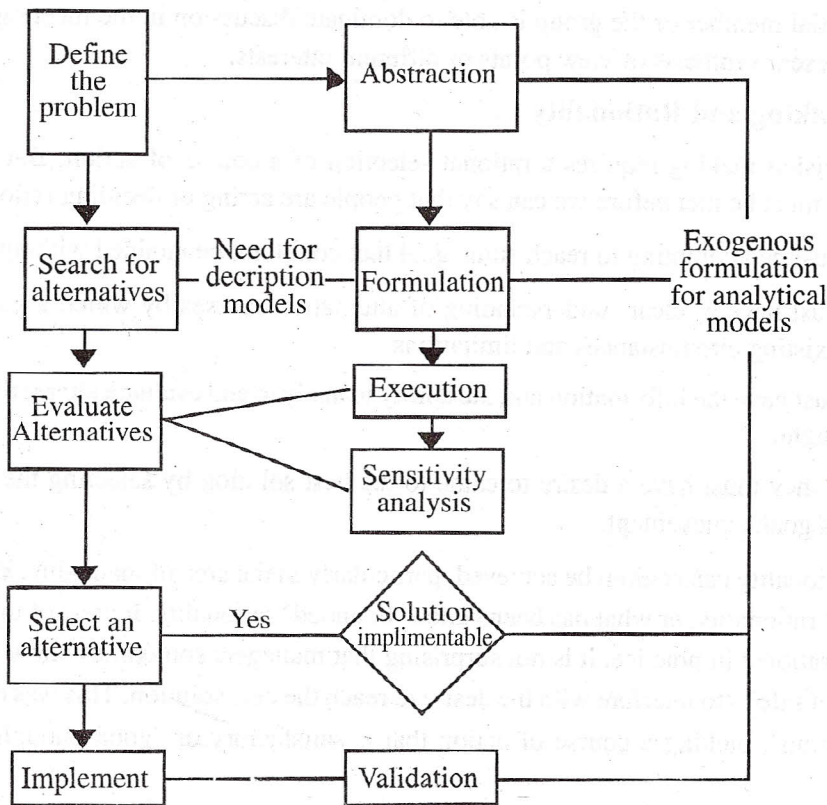

Figure 5.1 : Models Showing Phases of Decision Process.

**(A) Decision Tree Analysis :** Decisions generally involve a series of steps, the second step depends as the outcome of the first; the third step depends as the outcome of the second and so on. Decision trees are a model for solving such problems. Decision tree is a graphical method for identifying alternative actions, estimating probabilities, and indicating the resulting expected payoff. Decision tree depicts future decision points and possible chance events hapenning. The construction of a decision tree requires definition of alternatives, estimation of probabilities for various events, and calculation of expected payoff resulting from an action.

**Example :** Construction of a Decision Tree / Drawing of decision tree. A company wants to go in for expasion programme with two choices and their respective payoffs with probabilities.

Choices : (a) Expansion with permanent tooling (b) Expansion with Temporary tooling

There are certain chance events with respective probabilities (which are shown in brackets)  
Let us know draw a hypothetical decision Tree.

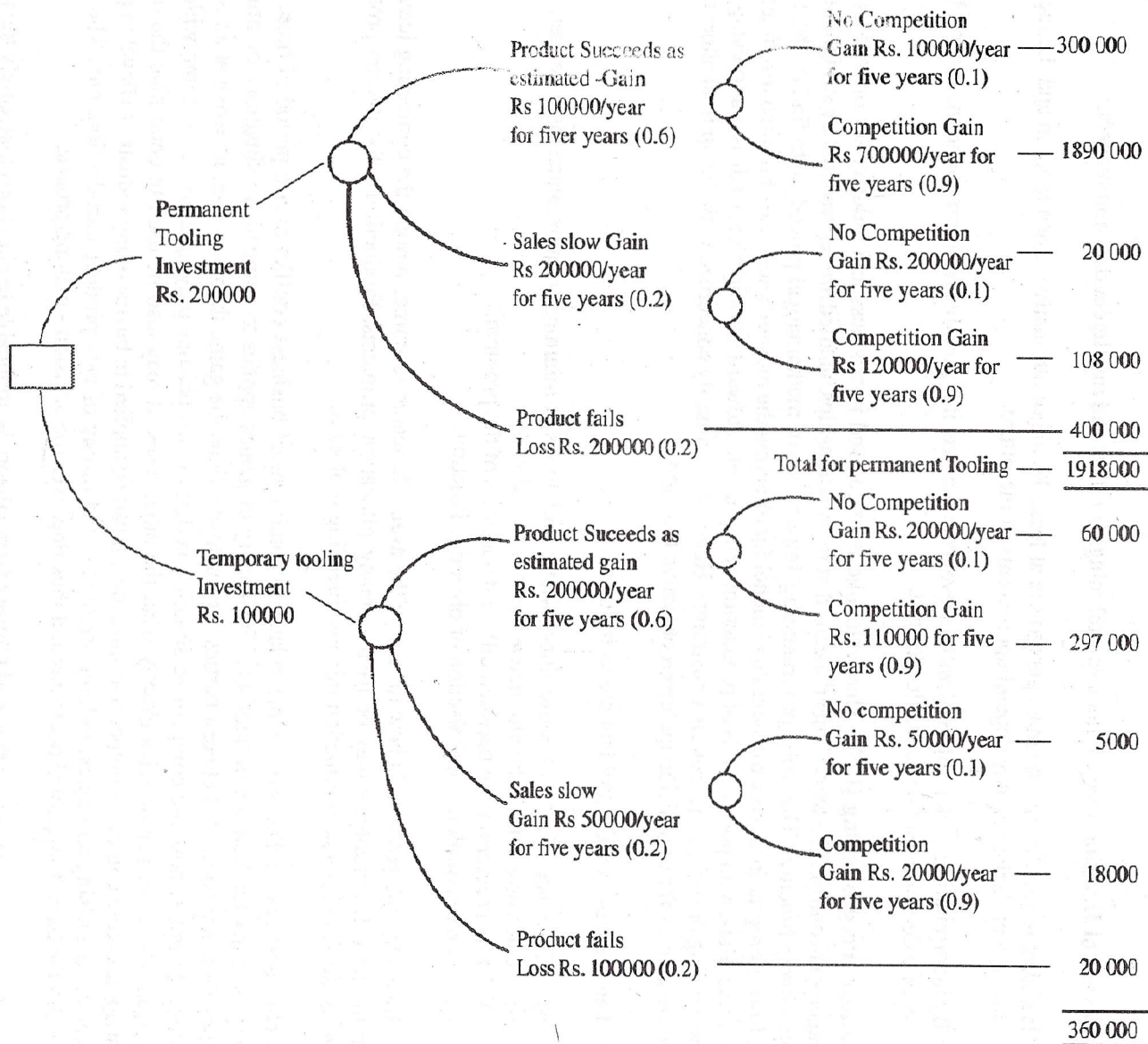



Figure 5.2 : Decision Tree Analysis



## Index

 Decision Point

 Chance Event

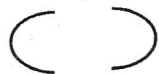
 Numbers given in the brackets are probabilities of chance event occurring.

**Significance of Decision tree :** It does several things for alert and intelligent decision makers.

- (i) It makes it possible for the managers to see at least the major alternatives open to them and the fact that subsequent decisions may depend upon events of the future.
- (ii) By incorporating probabilities of various events in the tree, it is possible to comprehend the true probability of a decision leading to results desired.

**B) Linear Programming (LP) :** This technique is often used in business and industry for operational and management control. The word 'linear' means that the relationships handled are represented by straight lines or involve linear function. The word 'programming' implies use of mathematical procedure to find the best solution. Linear programming is a mathematical model for directing the most efficient use of limited resources such as raw materials, man power, tools of production or capital etc., toward an objective, such as maximising profit or minimising the cost under certain constraints. Hence it is primarily concerned with the optimal allocation of scarce resources for optimising the given objective function.

The features of a LP problem are as follows :

- a) Existence of a set of constraints - where limitations or minimum requirements must be met.
- b) Choosing among the alternative courses of action
- c) Linear relationship between different variables of the problem.
- d) A best solution - optimisation of objective function

Basically, the problem is how to assign the available scarce resources among the competing jobs to do each job best. LP problems may be used as many 'allocation' problems. Production / distribution problems, transportation problems, production mix and blending problems.

**(C) Game Theory :** The term 'game' relates to conditions of business conflict over a period of time. Game theory is really the 'science of conflict'. The Theory of games applies to competitive situations or situations where there are conflicts between parties. In such situations the game theory is used to arrive at an optimal strategy. Simplest possible competitive situation is that of two persons playing zero - sum game which is a situation where one person wins exactly what the other loses. It may also be used to determine the optimal strategy for more complex competitive situations. It can be applied in business and industry to develop pricing policies, advertising strategies, bidding strategies, and timing of new product introduction, etc., The theory provides the basis for rational decisions and thus improves the decision - making process.

**Underlying Assumptions or Rules of Game :** Game theory is applicable to situations that satisfy the following conditions :

- a) The number of competitions is finite
- b) The players act rationally and intelligently
- c) Each player has available to him a finite set of possible courses of action.
- d) There is a conflict of interests between the participants.
- e) The players make individual decisions without direct communication.
- f) The rules governing the choice are specified and known to the players.
- g) The players simultaneously select their respective course of action.
- h) The pay off (outcome) is fixed and determined in advance

**Game Theory -Terminology :** The basic elements of game theory are as follows :

**(a) Payoff :** It is the outcome of playing the game or the net gain the strategy brings to the firm for any given counter - strategy of the competitor. The payoff is measured in terms of the objective of the firm like increase in profits, expansion in actual market share, etc.,

**(b) Payoff Matrix :** The following hypothetical table shows the outcomes or payoffs of different strategies of the game. This table illustrates a payoff matrix of a 2 person zero seven game.

		Payer - B		
		B <sub>1</sub>	B <sub>2</sub>	B <sub>3</sub>
Payer - A	A <sub>1</sub>	24	36	8
	A <sub>2</sub>	24	20	16

In this payoff matrix, a positive payoff denotes gain to the maximising player (shown as row) and loss to the maximising player (shown as a column). For example, if player A chooses strategy A<sub>2</sub> and player B the strategy B<sub>1</sub>, this results in the gain of 32 to A and loss of 32 to B

**(c) Optimal Strategy :** It is the course of action or plan which puts the player in the most preferred position. Any deviation from this strategy results in a decreased payoff for the player.

**(d) Value of the game :** It is the expected payoff of play when all the players of the game follow their optimal strategies. This game is called fair if the value of the game is zero, and unfair if it is non-zero.

**(e) Rules of the play :** These rules constitute the framework within which players choose their strategies. They determine whether the game is played entirely in one move or is played sequentially in a series of moves. The rules also specify whether or not the players are permitted to communicate and collude with one another.

**(f) Saddle point :** It is the point where maximin value equals the minimax value. The saddle point is the solution or value of the game. Once saddle point exists for a game, the optimal strategy for two players can be identified. Solution of games with no saddle point is possible only through the use of mixed strategies.

**(g) Rules of dominance :** A strategy is called dominant if each payoff in the strategy is superior to each corresponding payoff in an alternative strategy. The alternative strategy can be ignored because it will not affect the solution in any way.

#### **Advantage of Games Theory :**

- (i) Game theory helps in determining the best course of action for a firm in view of the expected counter moves from the competitions.
- (ii) It provides a scientific quantitative technique for arriving at an optimal strategy to realise given objectives.



- (iii) Game theory gives insight into several less known aspects of situations involving conflicting interest. For example, it describes and explains the phenomena of bargaining and coalition formation.
- (iv) Business men have very often to make decision under conditions of conflict. Game theory is helpful in handling the situation of inter dependence of firms. It provides a frame work for decision - making when the competitor's reactions to the firm's action are uncertain and unknown.

### 5.9. Summary :

The role of premises in planning, the types of premises are discussed. The planning premises are classified as internal / external, quantitative / qualitative; controllable / non - controllable. Later, it was also explained the concept of decision making, its process, group decision making, systems approach to decision making and decision making techniques.

### 5.10. Self Assessment Questions

1. What is the importance of premises in planning?
2. Describe briefly external and internal premises in planning?
3. Critically examine the decision making process in organisation?
4. Examine the role of Group Decision Making in Organisation. Explain the limitations?
5. What is bounded rationality in decision making?
6. Bring out the importance of decision making techniques.
7. Explain in detail the following decision making techniques..  
a) Decision Tree b) Linear Programming c) Game Theory.

### 5.11. Further Readings

- \* Personnel / Human Resource Management, Keith Davis
- \* Personnel / Human Resource Management, Gary Dessler
- \* Personnel / Human Resource Management, VSP. Rao and PSP. Rao
- \* Management, Text and cases, VSP, Rao, Hari Krishna

**Lesson - 6****ORGANISING**

**Objectives :** After studying this lesson you should be able to :

- understand organisation as a process and structure
- identify the principles of organisation structure
- develop organisation structure and understand the issues involved there in.
- distinguish between Formal & Informal organisation

**Structure :**

- 6.1 Organisation as a process and a structure
- 6.2 Traditional principles of organisation structure
- 6.3 Developing organisation structure
- 6.4 Formal and Informal organisation
- 6.5 Importance of Organisation
- 6.6 Summary
- 6.7 Self Assesment Questions
- 6.8 Further Readings

**6.1. Organisation as a process and a structure :**

Organisation is a mechanism or structure that enables living things to work effectively together. The evolution of all forms of life and of human society demonstrates the need for organisation. Organisation in common parlance is used in the sense of an enterprise or a business Unit. The behavioural scientists and the sociologists view organisation as comprising human relationships in group activity. It is referred to as the social system encompassing all formal relations. And yet another useful way of looking at organisation is to consider it as an essential function of management. In operational sense, organisation can be considered as consisting of division of work among people and coordination of their activities towards some common objectives. The important steps in organising are:

- (i) Enumeration and grouping of activities of the enterprise consistent with its objectives.
- (ii) Assignment of activities to different executives
- (iii) Delegation of authority and placing of responsibility for carrying out the assigned duties.
- (iv) Making provision for effective coordination between them and establishment of definite lines of supervision.

Organisation as a structure is the particular system of arrangements, the pattern of network of relations, between various positions. The structure is not accidental. The key executives determine the structure which they feel will best serve company needs, because the relationships are created and defined through the exercise of authority.

The organisation chart is a useful static model of this formal structure. Understanding the organisation as a structure of authority relations is considering it in the formal or traditional sense. However organisation process is much more complex than as traditionally viewed by many. Theories have been developed to describe organisation as a system of human relationships, social system, or the total system comprising a number of interacting subsystem.

Organisation can be defined as the "process of indentifying and grouping the work to be performed, defining and delegating responsibility and authority, and establishing relationships for the purpose of enabling people to work most effectively together in accomplishing objectives".

The organisation structure is not an end by itself, it is rather a means to an end. Organisation structure is created to achieve certain goals, and organising inturn is done to accomplish those objectives. Peter F. Drucker suggests three ways of discovering the kind of structure needed to attain objectives : These are (i) Activity analysis (ii) Decision Analysis (iii) Relation Analysis.

Some writers decribe organisation as a type of "open system" Constantly interacting with the environment for its survival and growth. The organisation as an open sytem must, therefore, define it objectives in relation to the environment and constantly adapt to changes. Defining objectives of the enterprises is thus necessary not merely for the purpose of dividing the work but also for its survival and growth.

Organisation is closely related to other phases of management. This becomes more obvious when we consider changes in the organisation structure and project effects of such changes on other taks of management. In fact, changes in organisation structure must be matched by suitable changes in planning, staffing and controlling. Thus organisation should always be viewed as part of the total management task.

**6.2. Traditional Principles of Organisation Structure :** Traditional organisation theorists developed certain principles of organisation as guides to thinking in organising. These principles are intended for universal application to all enterprises and cooperative efforts in different fields. The most important of these principles can be listed under the following heads :

**(i) Division of Labour or Specialisation :** Frederic W.Taylor applied Division of labour principle at the operation level and displayed how efficiency could be increased by breaking down jobs into single repetitive taks performed on specilised tools.

**(ii) Consideration of objectives :** Objectives are helpful in determining the activities and the structure itself. Once objectives are clearly defined, the organiser can conveniently proceed to group activities, delegate authority to individuals to whom activities have been assigned, and coordinate their efforts for better results.

**(iii) The Scalar Principle :** The vertical dimension of organisation structure consists of levels of authority arranged in a hierarchy from the chief executive at the top to the first line supervisor at the bottom. Existence of these levels is always the characteristic of organised and coordinated group efforts. The Scalar principle holds that organisation consists of two or more levels of authority. In organisations, the levels represent graduations of distributed authority.

**(iv) The Principle of Departmentation :** Logical grasping of related jobs and functions is quite natural in developing the organisation structure. Departmentation requires analysing everything that has to be done and determining the grouping in which it can be placed without violating the principle of homogeneity. Departmentation is desirable because individuals vary considerably in the range of activities which their abilities will permit them to perform effectively.

**(v) The Principle of Unity of Command :** A business organisation must have a single head in whom all authority and responsibility is concentrated, but this has to be blended with the efforts of the organised people below. Unity of efforts, consistency of direction, high morale, and effectiveness of coordination depend upon one executive as the locus of ultimate responsibility.

**(vi) The Principle of span of control :** The idea of span of control is related to the horizontal dimension of an organisation structure. Span of control (also referred to as the span of supervision or span of management) refers to the number of subordinates reporting directly to the executive, the more difficult it tends to be for him to supervise and coordinate them effectively.

**(vii) the Principle of Flexibility :** Organisation is created to accomplish certain goals. Both the environment and the individuals comprising the organisation are constantly in flux. To cope with these changes and yet reach its objectives, an organisation must be designed with sufficient amount of flexibility.

**(viii) The Principle of Balance :** This principle implies that each area and function of an enterprise should operate with equal effectiveness in making its allotted contribution to total purpose. The idea of balance applies to organisation structures as well as to functions and process. Changes in the organisation structure should be made after giving full consideration to balance, and by avoiding over-reliance upon any single type of structure; Horizontal and vertical dimensions should be maintained and kept in balanced relationships to one another.



**(ix) The Exception Principle :** This principle implies that only problem involving unusual matters should be referred to upward and decided by higher level executives, and that routine problems should be passed on to lower levels and resolved there itself. Exception principle is also the principle underlying delegation of authority.

**(x) Principle of Decentralisation :** This principle is of great significance in the organisation, specially to large enterprises. One important implication of decentralisation is delegation of broad authority and decision making power to the semi-autonomous units. Decentralisation in an organisation of decision making authority is pushed down to its lower level and as near the source of information and action as possible.

**(xi) Principle of simplicity :** Simplicity is an appealing objective because it implies economy of efforts. It is desirable to consider simplicity of structure in develop an organisation, aiming for as clear - cut structure as will permit doing the necessary work efficiently.

**(xii) Combination of Line and Staff Functions :** Organisation structures are usually of line, staff and functional types. Line structure is part of every organisation. The staff and functional types are modifications of the line structure. Staff and functional structures never exist apart from a combination with line structure.

The above principles should be used as more fundamentals or guides to actions while designing the organisation structure.

**6.3. Developing an organisation structure :** Designing a new organisation structure or reorganising an existing one calls for careful consideration of current practices and principles of organisation. There are no such rules as to which will lead to the best organisation structure. But the following steps can be of great help in designing a suitable structure which will aid in achieving enterprise objectives.

**(i) Clear Definition of Objectives :** The first step in developing an organisation structure is to lay down its objectives in very clear terms. This will help determine the type, stability and basic characteristics of the organisation. Infact, organisation activities are detailed in terms of objectives to be achieved.

**(ii) Identifying the Activities and Grouping them in to convenient classes :** The next important step in developing an organisation is enumeration of activities necessary to achieve the objectives, their grouping in a systematic manner, assignment of such groups of activities to personnel, and providing for their coordination. Wherever possible, similar functions should be combined into one position.

**(iii) Determine the Structure :** The first two steps outlined above set the stage for actual determination of organisation structure. More specifically, the manager has to decide about the span of supervision, types of organisation, basis of departmentation, and the pattern of authority structure.

**(iv) Revise the Sytem on the Basis of Assessment of personal and funds :** The last step in developing a suitable organisation structure is to assess the capabilities and abilities of the people available to man different positions in the organisation along with other resources at the disposal of the enterprise. The ideal organisation should then be adapted to fit the reality of the situation.

Though the above steps provide general guidelines; local condition, business objectives and policies, scale of operation, nature of work, and above all character and abilities of personnel available are impartant factors to be considered while developing an organisation structure.

#### **6.4. Formal and Informal Organisations :**

**(a) Formal organisation :** The formal organisation is a sytem of well-defined Job, each bearing a definite measure of authority, responsibility, and accountability, the whole consciously designed to enable the people of the enterprise to work most effectively together in accomplishing their objectives. The formal organisation is characterised by being will-defined, found by delegation, and relatively stable.

The formal organisation is a more or less arbitrary structure to which the individual must adjust. It tells him to do certain things in a specified manner, to obey orders from designated individuals, and to work cooperatively with others.

The formal organisation fecilitates the determination of obejctives and policies. A relatively fixed and predictable form of organisation is necessary if the company is to forecast its probable future accomplishment.

Definite limits for the activities of people are set by the formal organisation. Defined responsibilities and authority provide relatively fixed fences within which people can develop their own work areas to the maximum without encroaching on the work of others.

In the formal organisation, the work that each individual does is part of a larger pattern. Except in the case of few individuals at the top, no one person can see both the begining and the end of the work he does. Because each person in the formal organisation is, to an extent, working "blind", interms of the overall plans and objectives of the organisation, he needs to have his part in the overall activity spelled out for him; he cannot determine this for himself.

Coordination proceeds according to a prescribed pattern in the formal organisation. People meet in committees to unify and time their joint activities. One person is required to check with another before proceeding.

Because of these arbitrary requirements, the formal organisation tends to restrict and circumscribe the activities of individuals. It sets up boundaries, and pathways which must be followed.

**(b) Informal organisation :** The informal organisation refers largely to what people do because they are human personalities to their actions in terms of needs, emotions, and attitudes, not in terms of procedures and regulations. In the informal organisations, people work together because of their personal likes and dislikes.

Informal organisation is an important concept in the study of organisation. People in the formal organisation have a tendency to cut across formal channels and communicate informally with other parts of the organisation. Formation of groups, cliques or subcliques is all pervasive. People tend to be motivated by group norms, social conventions and leaders enjoying no formal authority. Thus, there exists or more complex and complicated system of informal relationships along with the formal relations in the organisation. Such informal relations are not portrayed in the organisation charts and manuals.

Chester. I. Barnard viewed informal organisation as Joint personal activity without conscious joint purpose, even though possibly contributing to joint results. Keith Davis regards informal organisation as the network of personal and social relationships which is not established or required by formal organisation. Thus informal organisation comprises the whole set of customs, social norms, and ideas by which people are influenced.

Informal organisation is characterised by the following features.

- (i) It develops spontaneously and is not established by formal managers.
- (ii) It is based on informal authority attached to the person, and not the position. Informal authority is earned and not delegated. This authority under informal organisation largely flows upward or horizontally.
- (iii) Informal organisation represents human tendency to cut across formal channels and communicate informally with other parts of the enterprise.
- (iv) People in the informal organisation are influenced by leaders without any formal authority.
- (v) It is all - pervasive and exists in every enterprise.
- (vi) Informal organisation is not always destructive though at times it can make the job of managing more difficult. Because of its powerful influence on productivity and job satisfaction, formal management will do well to derive benefit from the study of informal organisation.

(vii) Informal organisation cannot altogether be abolished. Informal organisation is not created at the will of the formal managers; nor the latter can do away with all the social conventions and group norms.

**(c) Control of Informal Organisation :** organisation should be viewed as a positive force. Informal organisation lightens the burden of formal manager. It helps to fill in the gaps in formal orders and managers abilities, provides for satisfaction and stability to the workmen. However, benefits of informal organisation will accrue only when it is properly controlled and its potential power properly channelised. The significant aspects of manager's duty in this connection are :

- (i) He should recognise and reconcile himself to the existence of informal organisation.
- (ii) He should influence the informal organisation, so that its role is positive and the negative aspect is minimised.
- (iii) He should integrate informal organisation with formal organisation in such away that the former also contributes to the accomplishment of enterprise objectives.
- (iv) He should make informal organisation secondary to formal organisation, and not vice versa.

**6.5. Importance of organisation :** Sound organisation can contribute greatly to the continuity and success of the enterprise. This is often not apparent to the average businessman, who tends to equate sound organisation with neatly drawn and symmetrical organisation charts and to assign it to a subordinate who is not too busy with more important things.

Organisation is more than a chart it is the mechanism through which management directs, coordinates and controls the business. It is, indeed, the foundation of management. If the organisation plan is ill-designed, if it is merely a makeshift arrangement, thus management is rendered difficult and ineffective. If, on the otherhand, it is logical, clearcut and streamlined to meet present day requirements, then the first requisite of sound management has been achieved. Sound organisation facilitates administration of the company and its parts, encourages growth and diversification, and helps improve the operation of the business as a whole.

Sound organisation stimulates independent, Creative thinking and initiative by providing well-defined areas of work with broad latitude for the development of new and improved ways of doing things. Properly conceived, the organisation structure will demand creative results from creative people and will drain routine and repetitive work to supporting positions. By establishing clear - cut accountability, it will provide recognition for the professional and the specialist interms of their achievement.

**Activity / Assignment :** Devise a suitable organisational structure for a public limited company producing and selling electric lamps. It has regional head offices at four places of the country. The head office is located in Kolkatta with its production unit also in Kolkatta.

### 6.6. Summary :

It is discussed about the nature of an organisation, its process and structure, principles of organisation, designing an organisational structure. The organisations are classified as formal and informal. The explanation on the control of informal organisations is also made along with the importance of the organisation.

### 6.7. Self Assesment Questions :

1. Define organisation and discuss the principles of organisation structure.
2. Define organisation structure. Enumerate the essential steps involved in organising.
3. Distinguish between formal and informal organisation.

### 6.8. Further Readings :

- \* Personnel / Human Resource Management, Keith Davis
- \* Personnel / Human Resource Management, Gary Dessler
- \* Personnel / Human Resource Management, VSP. Rao and PSP. Rao
- \* Management, Text and cases, VSP, Rao, Hari Krishna

**D V Ramana Murthy**

**Lesson - 7****AUTHORITY AND RESPONSIBILITY**

**Objectives :** After you have completed this Lesson, you should be able to :

- understand the nature of authority and responsibility.
- identify the problems of span of Management
- know the essentials of delegation of authority, its process and limitations.
- distinguish between centralisation and decentralisation.
- understand the need and types of departmentation.

**Structure**

- 7.1 Nature of Authority
- 7.2 Span of Management
- 7.3 Delegation of Authority
- 7.4 Centralisation and Decentralisation
- 7.5 Departmentation
- 7.6 Summary
- 7.7. Key words
- 7.8 Self Assessment Questions
- 7.9 Further Readings

**7.1. Nature of Authority :** Authority is a term packed with variety of meaning by theorists and management practitioners. In everyday life authority is commonly understood as rightful power or right to command. Fayol defined as “The right to give orders and exact obedience”, and viewed this as official authority. Herbert A.Simon “Authority may be defined as the power to make decisions which guide the actions of another. It is a relationship between two individuals, one superior, the other subordinate. The superior frames and transmits decisions with the expectation that these will be accepted by the subordinate. The subordinate executes such decisions and his conduct is determined by them”.

**7.1.1. Features of Authority :**

- (i) Authority is basically legitimised and confers a right to the position holder by which he regulates the behavior of his subordinates to act or not to act in certain ways.

- (ii) Authority gives right of decision making because a manager can give order only when he decides what is to be done or not to be done by his subordinates.
- (iii) Authority is exercised to influence the behavior of those on whom it has been exercised.
- (iv) The authority itself is an objective because it is given to a position but its exercise may be subjective.

**7.1.2. Responsibility :** Very often we hear of ‘delegating responsibility’, carrying out a responsibility, ‘discharging a responsibility’, ‘possessing responsibility’, and like statements. Such statements are a pointer to the fact that responsibility is a term clogged with variety of meanings in the field of management.

Prof. Morris B. Harely defined responsibility as follows: “Responsibility is the duty to which a person is found by reason of his status or task. Such responsibility implies compliance with directives of the person making the initial delegation.”

George R. Terry has defined responsibility as the obligation of an individual to carryout assigned activities to the best of his ability.

**7.1.3. Authority and Power :** Authority and power are used interchangeably because of their objective of influencing the behavior of people on whom these are exercised. However, there is a difference between these two. While authority is the right to command, power is the capacity to command. Power is the ability to influence people. The differences between authority and power are as follows:

<b>Authority</b>	<b>Power</b>
<input type="checkbox"/> Authority is legitimised by certain rules, regulations, laws and practices.	In case of power there is such legitimisation
<input type="checkbox"/> Authority is institutional and originates because of structural relationships.	Power emerges of personal factors and varies with individuals.
<input type="checkbox"/> Authority exists in the context of organisational relationship, mostly in superior-subordinate relationships either direct or otherwise.	Power relationship may exist between any two persons and organisational relationships may not be necessary.

**7.1.4. Accountability :** Accountability denotes answerability for the accomplishment of the task assigned by the superior to his subordinate. Stephen P. Robbins states that : “Authority is the right to act, responsibility the obligation to carryout delegated authority, and accountability establishes reliability for the proper discharge of the duties delegated to the subordinate. Responsibility and accountability may seen similar, but they are different”.

It is to be noted that in all cases managers delegate their authority to the subordinates creating a particular responsibility and keeping them answerable for the accomplishment to him. In this way, authority goes down and down in the line making every one accountable for the duty assigned.

**7.1.5. Sources of Authority :** Earlier, management students and practitioners took authority for granted and did not care much for its origin or source, Henri Fayol Viewed authority as the right to command and the power to exact obedience. But gradually disagreement has developed as to the source of authority. There are broadly two theories regarding sources of authority - formal authority theory and the acceptance theory.

**(A) Formal Authority Theory :** The formal authority theory traces the sources of authority upward from any managerial position. Thus, the foreman derives his authority from the assistant production manager, assistant production manager from the production manager, production manager from the chief executive, chief executive from the Board of directors, Board of directors from the shareholders and soon. But the authority which is derived by the shareholders and soon. But the authority which is derived by the shareholders and the manager is limited by laws, government control and regulations, political and ethical considerations and by the economic institutions of competition, labour unions and the like. Thus the formal authority theory views authority as being transmitted from the basic Social institutions to the individual managers.

**(B) Acceptance Theory :** Some theorists and practitioners do not agree with the formal authority theory. In their search for a source of authority they look at the bottom of the organisational hierarchy where objectives are finally achieved. It is at this level that final decision is made to accept or reject the activity specified in the Communicative directive. Chester I. Barnard in his treatise 'The Functions of the Executive' viewed that "authority is the character of a communication (order) by virtue of which it is accepted by a contributor as governing the action he contributes; that is, as governing or determining what he does or does not do as far as the organisation is concerned". He further argues that the necessity of assent of the individual to establish authority for him is inescapable. According to this view of authority, one must know the conditions under which the recipient accepts the communicative directive as authoritative and acts accordingly.

Barnard Suggested fair conditions for this to be simultaneously met :

- (i) The recipient of the directive understands it
- (ii) The directive does not appear to be inconsistent with the purpose of the organisation.
- (iii) The directive is not incompatible with the purpose of the recipient.



(iv) The recipient is mentally and physically able to comply with the directive

It is only when these conditions are fully met, cooperation is secured and authority conferred upon the directive. Thus, the manager enjoys real authority only when the individual subordinate confess it upon him by accepting the communicative directive as authoritative.

**(C) Competence Theory :** The competence theory is more closely related to the acceptance theory of authority. Very often words of a few individuals carry more weight and are easily accepted by other people in the organisation irrespective of their position in the management heirarchy. Undenyingly, this is due to competence, better abilities, personal qualities or intelligence of such individuals in the organisation. The real source of a man's authority is then described to be his competence.

**7.1.6. Limits of Authority :** A Simple look at the organisation structure is sufficient to point out that the top management headed by the Board of Directors and the chief executive enjoys wider authority while its scope gradually narrows down as one descends the levels of organisation structure. The scope and limits of authority from the top to the bottom of the organisation may be visualised as an inverted pyramid with the first line supervisor at its bottom, indicating that there are more limitations as the scope of authority as one descends the managerial hierarchy.

The following figure broadly indicates this characteristics of authority.

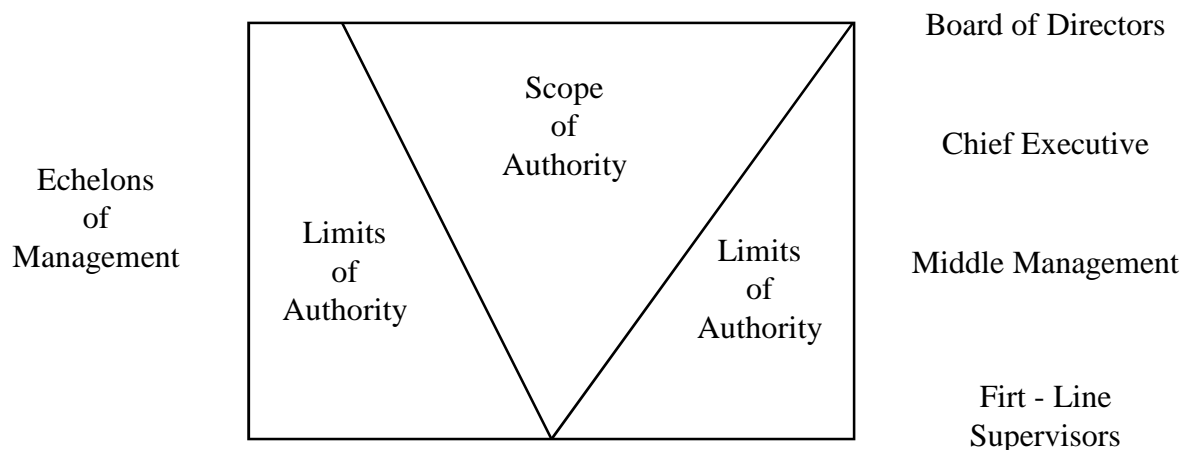

Figure : 7.1 Charecterstics of Authority

No manager enjoys unlimited authority. His authority is subject to definite limitations, internal aswell as external. Like all other social institutions authority is also subject to change.

**7.2. Span of Control / Management :** An organisation is characterised by the presence of a number of levels and departments. But more the levels are created, more will be the administrative cost due to additional staff required and more will be the difficulties to be encountered in communication and controlling. If this is so, why create departments and levels? Answer to this question is provided by the principle of span of management. This is basically the problem of deciding the number of subordinates to report directly to each manager. The principle starts that there is a limit to the number of subordinates that each manager can effectively supervise.

The problems of span of management is not a new one. Ever since the dawn of organised cooperation, man has experienced and realised that no individual can effectively supervise an infinite number of subordinates. Individuals differ in their ability to get along with people and also in the physical and mental energy they possess. Such personality and energy limitations also affect the executive's span of management.

**7.2.1. Wide Vs Narrow Spans :** Span of management directly affects the number of levels in the organisation. Wider Spans of management lead to flat organisation whereas narrow spans of management result in turn organisation structure.

Narrow spans lead to many levels in the organisation and thus require a large number of managers. This in turn, leads to larger expenses in the form of executive remuneration. Narrow spans also reduce opportunities for management development. Too many levels hardly allow for delegation of any real authority and greatly limit the supervision to a very few activities at lower levels.

Supervision of too many people, as the other hand, can also lead to trouble. Supervision will become less effective because the manager will not have sufficient time and energy to attend to each of his subordinates.

**7.2.2. Factors determining optimum Span of Management :** What spans are feasible in a given situation are generally influenced by a number of factors.

**(i) Time required to be spent on supervision :** The more is the time required to be devoted to processes other than supervision, the narrower should be the span of management for such administrative position.

**(ii) Subordinate Training :** A Manager dealing with trained subordinates can afford to supervise a large number of them and operate with a wider span.

**(iii) Delegation of Authority :** In an enterprise which is effectively organised and structured, management is able to influence and minimise the frequency and severity of superior - subordinate relationships and thus increase its span. An important symptom of an inefficient organisation influencing span of management is to be found in ambiguous or inadequate authority delegation.

**(iv) Degree of Decentralisation :** Centralisation results in manager having less time to spare for supervising, on the other hand, manager operating under decentralised set-up is relieved of much of the burden of making programmed decisions and can afford to supervise relatively a larger number of subordinates.

**(v) Similarities of the functions supervised :** Similarity in variety of functions to be supervised by the manager also influences his span of supervision. Where the executive manages similar functions (which are perhaps repetitive also), he becomes well versed with jobs and can handle a larger number of subordinates.

**(vi) Planning required of the supervisor :** As the importance, Complexity and time required of the manager in performing his planning function increases, it will be more reasonable to reduce the number of subordinates.

**(vii) Use of Objective Standards :** Use of objective standards of performance, saves the time of the manager, and the manager can concentrate on points of strategic importance thus widening his span of supervision.

**(viii) Territorial continuity of functions supervised :** Where functions are geographically separated supervision of components and personnel becomes more difficult and time consuming. Geographic continuity of functions supervised by the manager, therefore, operates to reduce his span of control.

**(ix) Availability of staff Assistance :** Provision of staff assistance helps the executive to supervise on large number of subordinates.

Thus while determining the actual span of supervision for each of the managerial positions in the organisation, the organisation analyst should evaluate these factors for each of the managerial positions in the organisation separately and as the basis of his experience the effective span is to be devised.

**7.2.3. Graicunus' Theory of Superior - Subordinate Relationship :** V.A. Graicunus, a French management consultant, analysed superior subordinate relations and classified these relationships into three forms:

- a) Direct single Relationship between the senior and each of his subordinates individually.
- b) Direct group relationship between the manger and each of the possible combinations of subordinates.
- c) Cross relationships between each of the groups of subordinates.

On the basis of analysis of the above relationships, Graicunus developed the following mathematical formula based as geometric increase in the complexities of managing.

Where, n indicates the number of subordinates supervised.

On the basis of this formula, the number of relationships increase from 490 to 1080 as the number of subordinates is raised from 7 to 8.

The formula may not be applicable to a given case, but it has the advantage of streamlining the problem of span of management better than any other device. The formula lacks the merit of ignoring frequency or importance of relationships.

**7.3. Delegation of authority :** Authority is the key to the management job, and manager without authority ceases to be a manager in the formal sense. In the sameway, authority delegation is the key to the organisation.

To delegate means to grant or conferring authority from one manager or organisational unit to another in order to accomplish particular assignments. A manager simply does not delegate authority, he delegates authority to get certain work accomplished.

**7.3.1. Elements of Delegation of Authority :** While delegating authority the manager must know what authority is to be delegated and with what limit. Obviously, no manager can delegate authority which he does not have, nor can he delegate all his authority without sacrificing his position as a manager.

**7.3.2. Delegation of authority involves three basic features :**

- (i) Assignment of tasks and duties ie., indicating what work subordinates must do.
- (ii) Granting of authority, ie., the executive who is delegating authority must transfer sufficient right or permission to the subordinates helping them to accomplish the assigned tasks.

- (iii) Creating an obligation i.e., once the duties have been assigned and authority is delegated, responsibility for accomplishment of tasks is then spontaneously fixed.

**7.3.3. Why manager fail to delegate? Barriers to delegation :** Delegation of authority represents the most important test of executive competence. It should therefore be well practised. A number of working rules and fundamentals have been developed to make delegation more effective. But as an art it has to be properly understood and learnt.

Delegation can both be defensive as well as aggressive some use delegation to reduce pressure (defensive), some executive use delegation to quicken the decision making process and results (Aggressive). But there are quite a few managers who prefer to withhold a large part of their authority under the pretext that even after delegation they still continue to remain responsible for the accomplishment of tasks assigned to them.

#### **7.3.4. Limitations to Delegation :**

##### **a) From superior side :**

- (i) A manager who wants to be indispensable in the organisation and behaves like an autocrat, is unlikely to delegate.
- (ii) A superior fails to delegate when he feels that his subordinates are not able or simply because of fear of subordinate's growth.
- (iii) A Superior may perceive that to delegate means incapacity to decide for self and there may be a fear of exposure.
- (iv) Lack of trust between superiors and subordinates also limits the scope of delegation.
- (v) Personality factors of the superior also influences the process of delegation.

##### **b) From Subordinates Side :**

- (i) They may not accept authority & Responsibility because of fear of Criticism and unfavorable results.
- (ii) Subordinates may lack self - Confidence.
- (iii) Lack of adequate resources limits the scope delegation.
- (iv) Lack of positive incentives for subordinates.

**c) From organisation Side :**

organisational factors include .

- (i) Managements philosophy and commitment towards the process of delegation.
- (ii) Centralisation and decentralisation in the organisation.
- (iii) Poor organisational Climate

**7.3.5. Principles of Delegation :** Delegation does not work as smoothly as the manager would expect. To overcome weak delegation and to make delegation more effective certain principles are enunciated which are as follows :

**(i) Clarity of Delegation :** Whether specific or general, written a unwritten delegation of authority must be very clear in terms of its contents, functional relations, scope and assignments. Principle of clarity of delegation also implies defining in clear terms the horizontal and vertical relationship of the position of each subordinate to other position in the organisation.

**(ii) Delegation to be consitent with results expected :** A manager before proceeding with actual delegation of authority to the subordinate, should know the jobs and results expected of such delegation He should there after delegate only that much of authority which is just sufficient to accomplish the results.

**(iii) Responsibility cannot be Delegated :** Obligation to accomplish the assigned task is absolute and is not partitioned when authority is delegated to the subordinate. Thus the chief executive even after delegation still remains accountable to the Board of Directors for management and supervision of the whole of the enterprise.

**(iv) Parity of Authority and Responsibility :** Whenever authority is delegated, responsibility steps in and is coextensive with authority. A subordinate can be held accountable for the tasks assigned to him and authority to the extent delegated for their accomplishment.

**(v) Exception Principle :** A manager delegates authority to the subordinate so as to be relieved of the overload which he thinks should be passed on to subordinates or to push down the process of decision - making as near the source of information and action as possible. In such a case it is expected that the recipient of authority shall make proper use of it and make all the decisions falling with in the scope of his authority. Only in exceptional cases when he cannot make the decision at his level should refer them upward for consideration and decision by the superior.

**7.4. Centralisation and Decentralisation :** Centralisation and decentralisation are not absolute terms. There are varying degrees to which authority can be centralised or decentralised. Thus absolute centralisation or decentralisation imply no organisation.

**7.4.1. Centralisation :** Centralisation refers to the tendency to withhold a larger part of formal authority at higher echelons of management hierarchy. Thus, larger number of decisions and more important of them are made by those occupying higher positions in the organisation.

**Advantages of Centralisation :** (Limitations of Decentralisation)

- (i) Uniformity of policy and procedure can strictly be enforced since decisions and controls are largely centralised.
- (ii) Centralisation helps to eliminate overlapping or duplicated activities and thus effects sufficient cost savings.
- (iii) Centralisation helps in fuller utilisation of talents of outstanding executives for enterprise as a whole.
- (iv) Centralisation ensures consistency of operating and uniformity of decision and, consequently, helps retain substantial control over activities of the enterprise.

**7.4.2. Decentralisation :** Decentralisation refers to the systematic effort to delegate to the lowest levels all authority except that which can only be exercised at central points. Decentralisation is concerned with the placement of authority with reference to responsibility.

Decentralisation should not be confused with delegation of authority. It should be noted that delegation can take place from one person to another and be a complete process. However, decentralisation is made to all, or most of the people, who are delegated a specific kind of responsibility.

**Advantages of Decentralisation :** (Limitations of Centralisation)

- (i) Decentralisation makes for quick decision and by pushing decision making closest to the situations improves quality of the decisions.
- (ii) Decentralisation helps improve effectiveness of managers. Development of self-reliant managers is encouraged.
- (iii) Democratization of management
- (iv) Decentralisation provides actual work experience to a large number of managers and thus creates a reservoir of promotable managerial manpower.

(v) Improved morale of personnel is another great advantage of decentralisation.

**7.4.3. Factors determining the Degree of Decentralisation :** Decentralisation is not an easy process. Both Centralization and decentralisation have their relative merits and limitations. The following are the factors which determine the degree of decentralisation.

**(i) Importance and significance of the Decision :** One of the significant factors determining the degree of decentralisation is the costliness of decision. Normally decisions which are costly in terms of money value involved or in terms of factors like goodwill and image of the establishment, employee morale or motivation tend to be centralised at the upper levels of management .

**(ii) Size of the enterprise :** There is no denying the fact that larger the firm, the more decisions to be made involving number of departments and levels, the harder it is to coordinate them. The size of the organisation should be so determined that department or units are easily manageable with authority considerably decentralised.

**(iii) Management attitude and philosophy :** Decentralisation is largely a question of character of top executives and their attitude. People with rational managerial temperament believe participatory approach and opt of decentralisation.

**(iv) Control techniques :** Though decentralisation helps quick decisions and enhances individual initiative, proper control techniques should be adopted to follow uniform policies for good corporate governance.

**(v) Availability of Capable managers :** Availability of capable executives substantially determines the nature and extent of dispersal of authority and responsibility.

**(vi) External factors :** External factors like, governmental policies, Unionisation and union involvement, competitive situation also exist certain influence as the mode of decentralisation.

**7.5. Departmentation :** Departmentation is concerned with grouping the various activities into separate administrative Units. It implies grouping of activities and employees into departments. Departmentation may thus be defined as the process of grouping activities into units with a view to ensuring effective management. Growth of the enterprise as well as the principle of specialisation is the genesis of departmentation.

In terms of the level at which it is done the process of departmentation may be divided into the following three stages :



- (i) Primary departmentation : ie., initial break-up of functions into basic activities.
- (ii) Intermediate departmentation ie., creating departments in the middle levels of the organisation.
- (iii) Ultimate departmentation : ie., dividing activities into separate units at the lower levels.

**7.5.1. Patterns Used in Departmentation :** Several patterns of departmentation are prevalent in the business world. The most common patterns are grouping by functions, products, territories, process, customers or by time.

**a. Departmentation by Function :** It refers to grouping of activities of the enterprise into major functional departments. With the growing complexity of administration, departmentation by functions has become widely accepted and increasing by popular.

Departmentation by functions, eg: Production, Marketing, finance etc., is the most widely used basis for grouping activities into administrative units and found in almost every enterprise at same levels or the other. This is illustrated in the following figure.

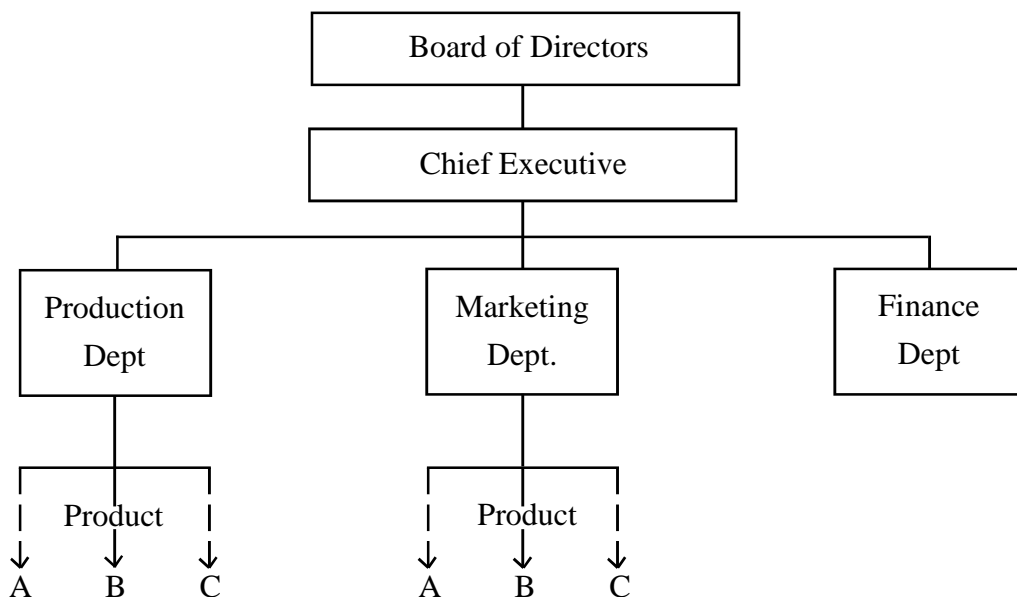

Figure 7.2 Department by Function

Functional departmentation represents a very natural and logical way of grouping different activities of the enterprise. Functional departmentation facilitates coordination within the function.

Functional departmentation tends to make the functional executives so much conscious of their respective functional areas that the business as a whole very often remain out of the sight of those executives.

**(b) Departmentation by Product or Services :** When activities associated with each product or group of closely related products are combined into relatively autonomous and integrated units within the overall framework of the company, such an organisation is described as product departmentation. Under this arrangement an executive is put incharge of all the activities relating to a product or product line and enjoys extensive authority over production, sales, development, service and other functions pertaining to that particular product, place of location of product Unit is irrelevant here. Product departmentation is illustrated here.

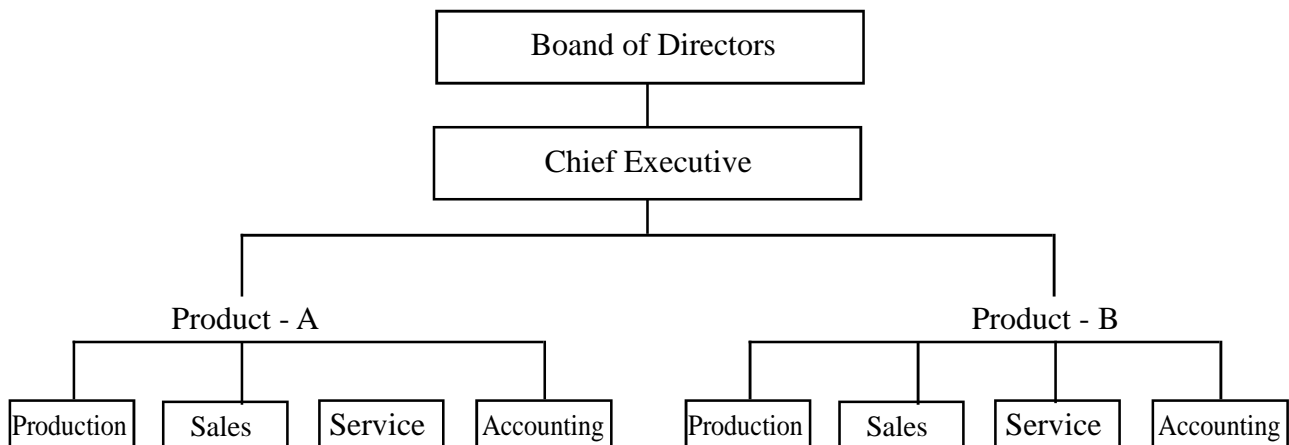

Figure 7.3 Department by Products / Services

Product departmentation enjoy the advantage of specialised product knowledge and promotes coordination of different activities connected with a particular product.

**(c) Grouping by locations or Territories :** When activities of the enterprise are physically or geographically dispersed, providing it with local administration desirable and at times requires in the interest of efficiency and economy in operations, such an organisation is viewed as territorial departmentation It may be mentioned that grouping by locations signifies adaptation to local needs and facilitates prompt actions.

**(d) Departmentation by Time :** Most of us are familiar with the “second shift” or the “night shift” concept. When operations extend far beyond the normal work period of an individual it may well be spread over certain shifts. Such a grouping is frequently termed as departmentation by time. Enterprises engaged in continuous process eg., public utilities, restaurants and many others departmentalise by time as a normal arrangement. Grouping by time is more common with production function of the enterprise.

**(e) Grouping by process and Equipment :** Activities may also be grouped into different departments on the basis of process involved or equipment used. Such as grouping is usually resorted to in a manufacturing concern. Thus, a cotton textile unit may have separate units for spinning, weaving, dyeing, inspection and shipping. Better supervision, optimal use of equipments, specialisation and avoidance of investment in duplicate are the important contribution of such departmentation.

**(f) Grouping by customers :** Departmentation by customers is more popular in sales activities of the enterprise. This pattern is usually followed when paramount interest is required to be shown in the welfare and interest of the customers for eg: Educational institutions offer regular and extension courses to cater the requirements of various clearly defined customer groups.

The problem pertaining to pattern of grouping activities of any enterprise cannot be resolved just by deciding infavour of a particular type. Activities should be grouped in the manner that will best contribute to achieving enterprise objectives and reduce its cost.

**7.6. Summary :** In this lesson we have discussed various issues relating to authority and responsibility. Authority is one of the important powers to make decision which guide the actions of another. We observed the distinction between authority responsibility and accountability. We also noted the ... and limitations of authority. Later, you are familiarised with span of management and the factors determining the optimum span of management. We also observed the need, scope of delegation, and the problems in delegation. The delegation, centralisation and decentralisation difference along with the influencing factors are also identified. In the latter part of the lesson, we have examined the departmentation and its process.

### 7.7. Key words :

- Authority : Powers and rights entrusted to enable performance of tasks assigned.
- Responsibility : Activities which must be performed to carry out the task assigned
- Accountability : Obligation to account for, and report upon the discharge of responsibility and/or use of authority.
- Power : Ability to exercise influence or control over others
- Delegation : entrustment of responsibility and authority from one person to another.
- Centralisation : Concentration of authority at higher levels of management
- Decentralisation : Systematic delegation of authority in an organisation wide manner.

**7.8. Self Assessment Questions :**

1. What is meant by authority ? Describe the features of authority?
2. Distinguish between authority and power.
3. Explain the concept of span of management. Discuss the factors determining the optimen span of management
4. What is delegation of authority? Why management fail to delepate?
5. Explain the concepts of centralisation and decentralisation. What are the advantages and disadvantages of centralisation and Decentralistion?
6. What is Departmentation? Explain the patterns used in departmentation?

**7.9. Further Readings :**

Allen, L.A, Management and organisation, Mc Graw-Hill, Aucklond, 1958

Drucker, Peter F. Practice of management, Heinemann, London, 1955

Management Tasks, Responsibilities, Practice, Allied publishers, New Dehli, 1955.

Koontz, D. and Donnell,C., Management : A System and Contingency Analysis of Managerial Fuctions. Mc Graw Hill Kognkusha Ltd., Tokyo.

Stoner, J.A.F., Management, Prentice Hall of India, New Delhi, 1982

Bedeian, A.G., Management, Dryden Press, New York, 1986

Taylor, F.W., The princiles of Scientific Management, Harper, New York, 1909.

**D V Ramana Murthy**

**Lesson - 8****LINE AND STAFF ORGANISATION AND COMMITTEES**

**Objectives :** After completing this lesson you should be able to :

- understand line and line and staff organisation
- know the sources of conflict and the need for cooperation between line & staff
- identify the essentials of delegation of authority, its process, limitations.
- understand the nature and working of Committees and their advantages and disadvantages.

**STRUCTURE :**

- 8.1 Line and staff Authority
- 8.2 Line organisation
- 8.3 Line and staff organisation
- 8.4 Conflict between Line and Staff
- 8.5 Minimisation of conflict
- 8.6 Committees in Management
- 8.7 Board of Directors
- 8.8 Summary
- 8.9 Key words.
- 8.10 Self Assessment Questions
- 8.11 Further Readings

**8.1. Line and Staff authority :**

The types of organisation employed by organisations vary considerably. However on the basis of the nature of authority, three fundamental organisation structures are commonly recognised. These are classified as follows.

- i) Line Organisation
- ii) Functional Organisation
- iii) Line and Staff Organisation.

Let us discuss in detail about Line organisation and Line and Staff organisation in this lesson.

## 8.2. Line organisation :

Historically, line type of structure is the oldest pattern of organisation. It is indispensable to all organised efforts and provides channels of upward and downward communication. It is simple and the most direct type of organisation. Here authority flows directly from the top of the organisation down to the lower echelons of management hierarchy. Each position in the organisation structure enjoys general authority. This type of organisation is simple and makes no provision for staff specialists.

Where as authority flows downward, responsibility in the line organisation flows upward. Scalar principle and principle of unity of command are strictly followed in this type of organisation.

The line organisation is shown in Figure 8.1

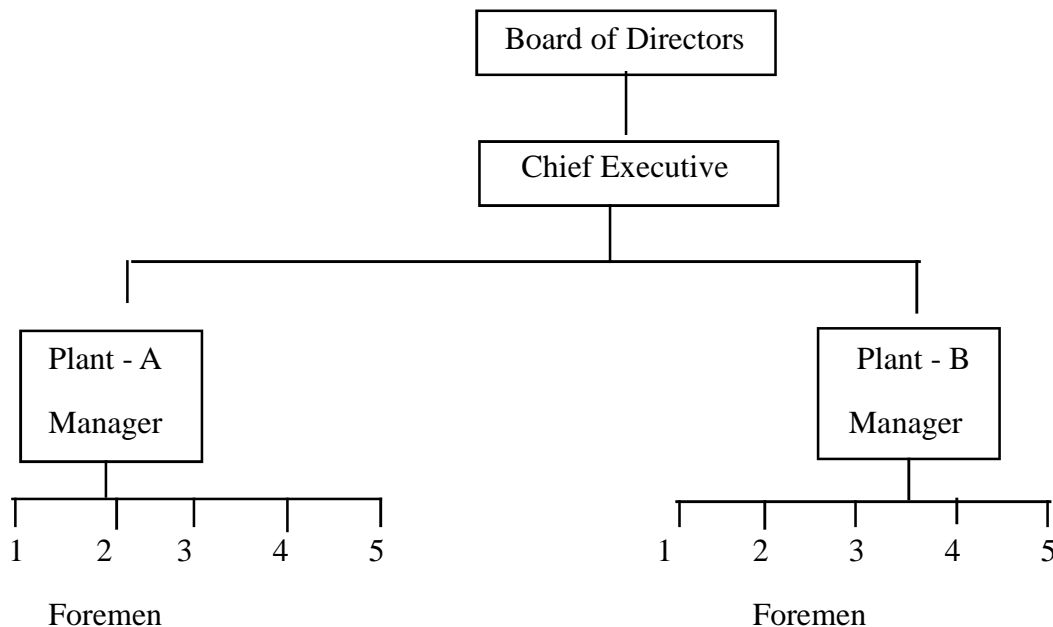

Figure 8.1 Line Organisation

### 8.2.1. Benefits of Line organisation :

- (i) It is simple to work. There are no staff positions
- (ii) It is economical and effective. It permits rapid decisions and effective coordination.
- (iii) It promotes unity of command and conforms to the scalar principle of organisation.
- (iv) It fixes responsibility for the performance of tasks in a definite manner upon definite individuals.
- (v) With a Unified control and undivided loyalty, line organisation ensures excellent discipline.

- (vi) It is less expensive due to non-involvement of staff personnel.
- (vii) It is stable.

### **8.2.2. Weaknesses of Line organisation :**

- (i) It suffers from lack of specialisation. Each department manager is to look after the activities of his own department only.
- (ii) There is possibility of key men being loaded to the breaking point. Since there is no staff aid the organisation can be seized by a strong man and run on an arbitrary basis. The loss of one or two key men may cripple the entire organisation.
- (iii) Such enterprise suffer from lack of expert advice. The managers may be compelled to make decisions irrespective of his ability or competence to do so.
- (iv) Line Organisation is rigid and inflexible. Discipline is maintained to the extent that organisation is rarely allowed to change.

### **8.2.3. The system can be utilized Successfully :**

- (i) Where the scale of business is small, number of subordinates and operative employees are not many.
- (ii) In continuous process industries.
- (iii) Where the work is largely of routine nature.
- (iv) Where the machinery is nearly automatic and does not call on the intelligence of the foreman.
- (v) Where labour-management problems are not difficult to solve.

### **8.3 Line and Staff Organisation :**

Under this organisation the “line” is supplemented by “Staff”. The Staff refers to officers who are not line managers but more or less permanently detailed to special services, or to the study of some phase of operations. Staff personnel thus act as an advisory group adjacent to the line.

This pattern of organisation came into being as a result of the departmental managers having to investigate, think and plan and, at the same time, performing ordinary tasks of production and selling. Consequently, the work of investigation, research, recording, standardisation and advising, i.e., the work of experts, were wholly distinguished and separated from the routine process of manufacturing and selling. Thus there arose a clear demarcation between ‘thinking’ and ‘doing’ the staff being the ‘thinkers’ and the line being the doers.

Line and staff organisation is illustrated in Figure 8.2.

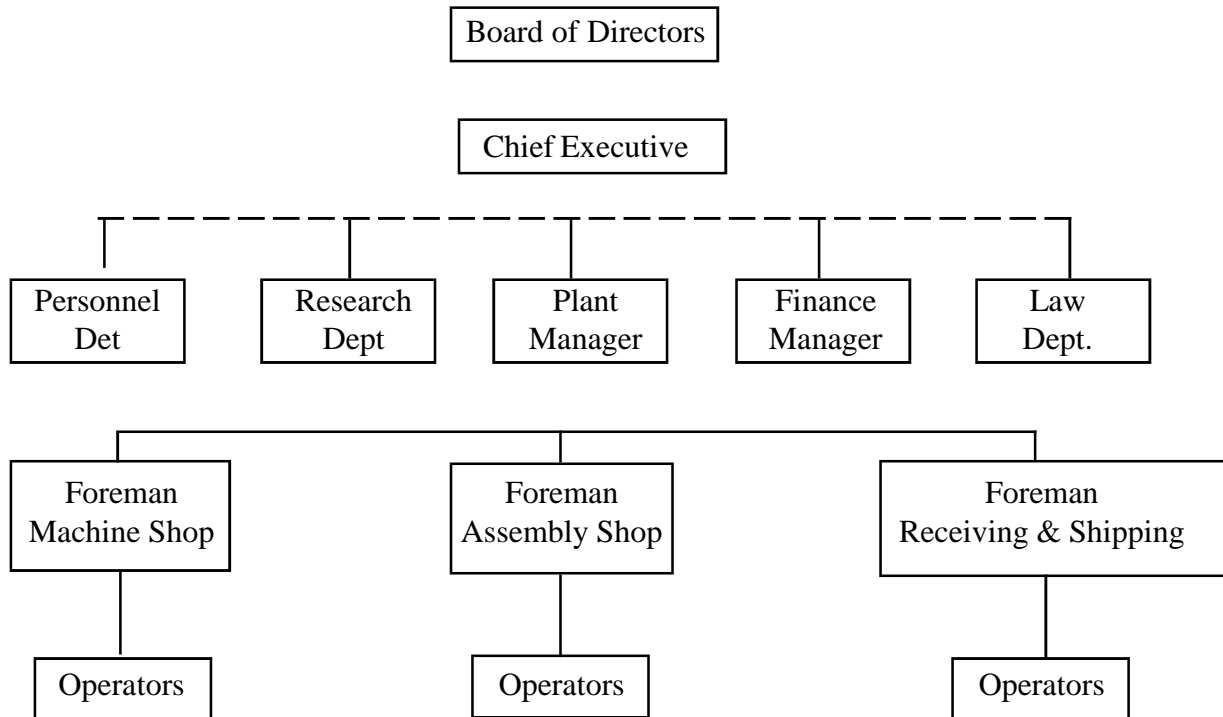

Figure 8.2 Staff Organisation

### 8.3.1. Merits of Line and Staff organisation :

- (i) It adds functional specialists to the pure line organisation and thus aims at combining the merits of the two.
- (ii) The stability and discipline of the line organisation are preserved; only the specialist is added.
- (iii) It brings expert knowledge to bear upon management. Functional specialists provide expert advice to the management on wide-ranging matters.
- (iv) It provides for better placement and utilisation of personnel and leads to more skill development.

### 8.3.2. Drawbacks of Line and Staff organisation :

- (i) The line and staff relationships often lead to numerous frictions and Jealousies.
- (ii) Line managers may depend too much on staff experts and thus lose much of their judgement and initiatives.
- (iii) The staff experts may remain ineffective because they do not get the authority to implement their recommendation.



**8.3.3. Line and Staff Concepts Criticized :** The behaviorualists point out how staff people originally conceived of as helping the line personnel tend to be regarded as source of interference than a source of help. Staff specialists who are most competent to make decisions relating to their respective areas of speciality are deprived of the opportunity to do so. There are also those who suggest that line - staff concept is obsolete, and have questioned the wisdom of, what they call, slavish adherence to the line-staff concept.

However, line and staff are useful concepts and their proper understanding greatly contributes to organisational effectiveness. The manager must know his position in the chain of superior - subordinate relations and be clear whether he is to advise or command.

**8.3.4. Kinds of staff :** Staff positions are organised as personal and specialised staff.

**a) Personal Staff :** Personal staff is created with the primary object of assisting the manager in doing those parts of his job for which he lacks inclination to delegate or cannot delegate. These matters include planning, policy making, coordination, control and human relations.

Personal Staff further sub-classified into line assistants, staff assistants and general staff assistants.

**(i) Line assistant :** A Line assistant is staff to his superior and advises or acts for him. Since he has no authority independent of his principal, he cannot redelegate his authority.

**(ii) Staff assistant :** He is usually described as “assistant to” and enjoy no authority over other employees. It is only when a task is specifically assigned to him, he acquires limited authority. His usual function is to open the mail, replying the telephone or speaking on behalf of his principal.

**(iii) General staff assistants :** General staff assistants are used in addition to specialised staff, and usually serve as advisers to top management in certain specified areas.

**b) Specialised Staff :** Specialised staff operates on functional basis, serves and advises all the line and other staff departments in their specialised functional area. Thus, personnel manager specialised staff helps all other departments in the organisation on personnel matters. Specialised staff occupies line authority within his department but enjoys no authority over other parts of the organisation. Secondly, specialised staff is available for use by all other or staff departments in the organisation. But his advice is confined to the specified functions or activity in which he is specialised and entrusted with.

#### **8.4. Conflict between Line and Staff :**

Ideally, line and staff should work together in harmony and as an integrated team. But, more frequently line and staff relations become a potent source of friction, inefficiency and organisational ill health. Rivalry

between them very often takes the form of animosity. Both line and staff have their own view points to offer relating to this problem.

#### **8.4.1. Line Viewpoint :**

- (i) Staff undermines line authority
- (ii) Staff thinks in vacuum
- (iii) Staff steals Credit
- (iv) Staff fails to give sound advice
- (v) Staff fails to keep the line informed

Line personnel enjoy authority to command and act to achieve enterprise goals. Staff is expected to give advice. Failure to recognise this and frequent encroachment by staff over line authority and prerogatives become the cause of friction.

#### **8.4.2. Staff View point :** The staff is equally critical of the line executives.

- (i) Lack of authority to command line subordinates
- (ii) Resistance to change by the line.
- (iii) Inability to make proper use of staff.

Allured by the special skill and ability in a particular field the staff is tempted to think that the solution to the problem recommended by him is best and needs be enforced on the line manager. Line is also charged with being short - sighted and resistant to change.

#### **8.5. Minimisation of Conflict :**

Line and staff are a matter of authority relationship having a direct bearing upon the organisational health. If in an organisation, line and staff work as an integrated team, organisational efficiency and effectiveness is bound to improve. But even under the best of circumstances possibly of conflict cannot altogether be eliminated, since Cooperation cannot be forced; rather people need be persuaded to cooperate. Coordination and Cooperation between line and staff can be ensured under the following conditions.

- (i) Line and staff should understand their proper position in the organisation. Staff should know that advising the line is their exclusive function. Similarly; line executives enjoys authority to command and is directly responsible for accomplishing enterprise objectives. Thus, proper understanding of their respective role

and relationships in the organisation structure will go a long way to minimise the conflict between line and staff.

- (ii) Line should be educated and encouraged to use staff effectively.
- (iii) Staff should realise that resistance to change is partly natural. They should, therefore, work for overcoming resistance to change. Staff should work on the assumption that it has to “sell” new ideas. Line executive should be encouraged to participate in the proposed scheme of change.
- (iv) Staff should realise that it commands respect and reputation in the organisation due to its skill and expert knowledge in a particular field. Thus, staff should constantly strive to acquire and increase its proficiency.
- (v) Staff should render complete advice on the problem concerned - They should present realistic recommendations and solution based on full consideration of all the pertinent facts.

### **8.6. Committees in Management :**

**Nature and Use of Committees :** A Committee may be defined as a group of people performing some aspect of managerial function. It represents a group of persons to whom a matter has been committed. A committee is a body of persons appointed or elected to meet on an organised basis for the consideration of matters brought before it. A Committee is sometimes referred to as a Board, Commission, Task force or a Team. Whatever be the title used; its essential nature is the same. Committees are generally formed as formal bodies with a definite structure. Eg : Executive committee, Bonus committee, Works committee, Grievance Committee etc.,

**The Plural Executive :** The plural executive may be established by law, or may be the result of a managerial decision. Board of directors, for example is the executive committee established by law. Plural executives are also formed internally by managers at different levels in the organisation.

The plural executive enjoys authority to make decisions and manage. The executive committees are often found playing an important role in policy making and developing major plans. Directors as a Board constitute the top plural executive in a company. Artificial entity and separation of ownership and management justify legal imposition as a company to be managed by the Board of directors.

**8.6.1. Advantages of committees :** Committees are sometimes described as an organised means of passing the buck. There are bitter complaints apart the inefficiency of the committee system. Though the committees are misused, let us now consider the positive view points on committees.

**(i) Integrated group Knowledge and Judgement :** An important reason for use of committees is the advantage of group dynamics and pooled knowledge and Judgement over individual Judgement. Pooled

Knowledge, experience and Judgement comprising different view points may be an invaluable assets particularly when complex problems are involved.

**(ii) Representation of Different Interest groups :** Committees are frequently used to give representation to important interest groups, such as Creditors, Customers, labour unions, and shareholders, Board of directors are often selected as the basis of groups interested in the organisation.

**(iii) Coordination of plans and policies :** Members of Committees from different departments better understand the need for coordination and the means by which it can achieved, when they meet together, exchange ideas and know about plans and activities of other departments.

**(iv) Executive Teamwork and Personal Interactions :** Committee organisation recognises the importance of the cooperative nature of management actions and personal association in the development of teamwork. Instead of individual competition, the committee encourages group accomplishment.

**(v) Wider participation and motivation :** Committees permit wider participation by subordinates and employees in the decision - making process. This gives them a feeling of belonging, and a sense of security and self-fulfillment.

**(vi) Improved Communication :** Committee offers a very useful instrument for transmitting and acquiring information. Face to face oral communication is generally a more effective form of communication than written reports and memoranda.

**(vii) Training for Executives :** Committees make positive contribution to the executive training and development. Subordinates get an opportunity to have insight into the problems facing other executives and the organisation generally, and thus experience problems beyond their present responsibilities.

#### **8.6.2. Disadvantages of Committees :**

**(i) High cost of Committees :** Committee system is not only costly in terms of time it consumes, but also in terms of money involved.

**(ii) Compromise and Indecision :** If the difference of opinion exists among members, there has developed the tradition of Unanimity before a decision is made by the committee, compromise must be reached or else there would prevail a climate of indecision.

**(iii) Minority Domination :** State of indecision and compromise, and also the possibility of domination by one or small group of influential members of the committee may pose a real danger to group deliberations and judgement.

**(iv) Devided Responsibility :** A committee represent the example of joint responsibility. But in practice members do not exhibit a sense of responsibility expected of them, and group responsibility is rather taken to mean no-body's responsibility. Devided responsibility is thus a serious limitation of committee system.

**8.6.3. Making Better Use of Committees :** Under certain circumstances committees can serve a very useful purpose in the running of different organisations. The following are the important prerequisites to make committee a useful tool.

**(i) Clear Definition of Purpose & Scope of Committee :** In order to avoid duplication and confusion and to improve its effectiveness, authority, scope, functions and organisational relationships of the committee should be clearly defined.

**(ii) Proper size of the committee :** Committee work should not be hampered because there are too many or too few members. Committee size is largely influenced by factors like purpose of the committee, personal abilities and participative skills of its members.

**(iii) Careful Selection of Members :** Success of the committee device is largely dependent upon the personality and skill of its members. Members should feel committed to group decisions and avoid individual domination over committee proceedings.

**(iv) The Right Chairman :** The Chairman of the committee should know his proper role. He should understand that his primary job is to expedite and fecilitate progress of the meeting. The chairman should be a highly skilled discussion leader and encourage members to express themselves freely. He should also know-how to settle differences and integrate committee deliberations.

**(v) Effective discussion procedure :** Logical procedure in conducting the meeting makes effective committee functioning.

**(vi) Follow up of the committee work :** Merely finalising the decision of recommendations is not sufficient. Minutes of the committee should be prepared and distributed to its members, and also communicated to the line superior.

**(vii) Evaluation of Committee work :** The work of the committee should be constantly evaluated in the light of its purpose and also to determine whether that purpose is still valid. Evaluation of committee work should also be done interms of the success and Quality of its decisions or recommendations.

## **8.7. Board of Directors :**

Generally ultimate authority of the organisations lies with the shareholders, but since all shareholders cannot participate in the management affairs of the organisation, normally such authority is exercised by board of directors. A board is elected by the owners of the organisation and is responsible to them as their agent for managing the affairs of the organisation. The board of directors can exercise the authority subject to the limita-

tions imposed by the Memorandum of Association and the Articles of Association as well as the relevant provisions of the Companies Act 1956.

### 8.8. Summary :

In this lesson the relative benefits and weaknesses of line organisation and the concept of line and staff organisation is presented. It also discussed the merits and limitations of line and staff organisation and the conflict between these two concepts. Like wise, the Committees Management and its relative merits and demerits are also presented in this lesson. At the end of this lesson, the role of Board of Directors and its authority is also described.

### 8.9. Key words :

- Line functions : Prose functions in an organisation which are perceived to be directly contributing to the organisation's objectives.
- Staff functions : Functions which are advisory or auxiliary in nature but do not directly contribute towards the organisational objectives.
- Conflict : Re extent to which people oppose and block each other
- Authority : Powers and rights entrusted to enable performance of task assigned.
- Committee : A formal group that is created to carryoutspecific organisatinal assignments or activities.
- Structure : Formal and established pattern of relationship in an organisation. Re relationship includes people, tasks and activites.

### 8.10. Self Assessment questions :

1. Explain the concept of line organisation and also the relative benefits and weaknesses of line organisation.
2. What is line and staff organisation and discuss the advantages and disadvantages?
3. Discuss the causes of conflict between the line and staff organisation.
4. Explain the concept of committees in Management also discuss the merit and demerits of committees management.

### 8.11. Further Readings

Kast, F.E., and Rosenweig, J.E., Organisation and Management. A System and Contingency Approach, McGraw-Hill Book company, New York, 1985.

Koontz, H.. and O'Donnell, C. Management: A System and Contingency Analysis of Managerial Function, Mc Graw-Hill, Kogakusha Ltd.,

Paul, S., Strategic Management of Develoment Programmes, Mangement Development Serices, Geneva, 1983

Schein, E., Organisational Psychology, Prentice Hall, Englewood Cliffs, 1980.

**D V Ramana Murthy**

## Lesson - 9

# STAFFING

**Objectives :** After studying this lesson, you are able to ;

- ☛ know the purpose of staffing
- ☛ identify the elements of staffing
- ☛ understand the recruitment process
- ☛ explain the selection and its process
- ☛ understand the induction process

**Structure :**

- 9.1 Introduction
- 9.2 Nature
- 9.3 Purpose of Staffing
- 9.4 Elements of Staffing
- 9.5 Summary
- 9.6 Key words
- 9.7 Self Assessment Questions
- 9.8 Further Readings

### 9.1. Introduction

Executives often talk of people that they are vital and the most invaluable assets to a business organization. But, the pitiable thing is that they are never shown on the balance sheet. The accounting aspect about human element of the organizations has been a big question of controversy. While accounting aspect of human element may be a subject of debate, there is no doubt in recognising that this human element determines the success (or) failure of an enterprise. Staffing (or) Human resource management as a managerial function is one that is used when we want to talk about the importance of "people" to an organisation.

Many management writers make staffing, an integral part of the managerial function - "Organising". But here, it is intended to deal with this 'staffing' separately. Staffing is defined as, "Filling and keeping filled, positions in the organization structure". [H.Knoontz]. This includes man power planning recruitment, selection, placement, promotion, training and development etc., importantly. Staffing is the process of matching the jobs with capable people. It is attracting, developing and evaluating people at work. It is determination of what people, what quantity people, and what quality people also.

**9.2 Nature :** The following describe the nature of staffing.

- \* It is concerned with employees / human element
- \* It covers all level personnel (or) people
- \* It's concern is to help the people
- \* It is inherent in all organisations.



- \* It is not ad-hoc but a continuous activity
- \* It attempts to secure willing co-operation of people for the attainment of organisational goals
- \* It is development oriented
- \* It is an integrating system in that it binds all people in the service of the organisation.
- \* It is an auxiliary service in the sense that it renders several services to the other important (line people) people in the organisation.
- \* It is all pervasive
- \* In Particular, staffing is related to other managerial functions Viz., planning, organising and directing.

**9.3. Objectives / Purposes of Staffing :** Staffing seeks to help the organisation achieve organisational goals. In that process, it does the following.

- It helps the organisation reach its goals
- It helps the organisation employ the skills and abilities of work force efficiently
- It helps the organization in supplying well trained and motivated employees for goal accomplishment.
- It helps the people in the organisation maximise job satisfaction
- It helps employees enjoy a better quality of working life
- It helps the organisational members in getting adequately informed of human resource policies
- It helps the organisation with the most economical organization structure in terms of optimum number of employees
- It helps organisational members in securing several opportunities for advancement.

#### **9.4. Elements of Staffing :**

Manager in charge of staffing may care for the following elements in the staffing process.

- \* Human resource planning (HRP) or man power planning (MPP)
- \* Job Analysis (JA)
- \* Recruitment
- \* Selection
- \* Placement and Orientation
- \* Training and Development
- \* Performance Appraisal
- \* Promotion etc.

These elements, except HRP and J.A., are discussed in greater detail in the following sections.

#### **9.4.1. Human Resource Planning :**

Briefly, it is the process of getting the right number of people qualified to suit to the jobs at the right time. It consists of the following steps in a large sized organization.

- (i) Forecasting the demand for human resources with some methods like : managerial judgement, ratio trend analysis and work study techniques.
- (ii) Forecasting the supply of human resources by taking stock of inventory of human resources on hand, potential additions and losses (or) wastages of human resources.  
supply forecast = present inventory of HRs. + potential additions – potential wastages.
- (iii) Estimating the net human resource requirements
- (iv) Preparing action plans for Redeployment, retrenchment etc.
- (v) Preparing action plan for recruitment, development etc.



- (vi) Modifying organisational plans
- (vii) Preparing retention plans etc.,

**9.4.2. Job Analysis (J.A) :** In order to materialize the objectives of HRP, it is very much essential to have knowledge about the requirements of jobs to be filled up. Staffing will be incomplete in the absence of this knowledge. So, job analysis comes here. It is a process of gathering information about a job. It is reducing the jobs to writing. This JA also is a step by step process and it includes multiple steps as under.

- (i) Organisational analysis
- (ii) Selection of Representative Jobs
- (iii) Collection of JA data
- (iv) Preperation of Job Description (JD)
- (v) Preperation of Job Specification (or) Employee specification (J.S. / E.S.)
- (vi) Overall picture of various jobs is essential. For this, entire organisational structure, is to be studied. Organisation charts will serve the purpose.
- (vii) Since it is costly to analyse all jobs, some sample in jobs is drawn.
- (viii) By observation (or) interview method, the required job data are collected.
- (ix) J.D. is all about what job doer does and doesn't do. JD is a written statement of what the job holder does, how it is done, under what conditions it is done, why it is done, where it is done, what are the materials / machines needed to do? Hence, it is all description about the Job.
- (x) Job specification (JS) is the next step. While JD is all about the Job, JS is all about the Job doer or job holder. JS describes the persons and personality to be processed to do a job. So, it is a written statement of personal attributes in terms of traits, skills, training experience connected with the Job.

Remaining elements of Staffing are discussed in the following sections :

#### **9.4.3. Recruitment :**

An important operational activity to be taken up by staffing manager is recruitment. As people / personnel are required to staff the organisation structure, recruitment comes to lime light.

Edwin B. Flippo defines that "Recruitment is the process of searching for prospective employees and stimulating them to apply for Jobs in an organisation. Still a more comprehensive definition can be tried. Dale Yoder puts it as - "Recruitment is a process to discover the sources of manpower to meet the requirement of the staffing schedule and to employ effective measures for attracting that manpower in adequate numbers to facilitate effective selection of an efficient working force".

Briefly, recruitment is discovering competent people for actual (or) expected positions in the organisational structure.

The above definitions may be summarised as under :

- \* It is not a single event activity.
- \* It is a linking activity.

- \* It is a positive one as it develops a pool of all competent persons
- \* Basic purpose of recruitment is to locate the required people
- \* Recruitment is a crucial and critical job as it has to reconcile several conflicting things and comply with a lot of legislative framework.

**Steps in the Recruitment process :** The following steps are involved in the process of recruitment.

- \* Organisational goals / objectives are to be carefully analysed and understood.
- \* Manpower plans must be made ready.
- \* A beginning for recruitment is made where the MPP ends.
- \* Action plan preparation by the man power planner stating that demand forecast is greater than supply forecast implying that there is fresh need for personnel in the organisation.
- \* Locating and developing the sources of required people is to be made.
- \* Prospective people with desired competencies are to be identified in these sources.
- \* Informing and inviting these competent people to apply for these positions in the organization.
- \* Attracting and enticing the candidates to think of our organisation with some strategies in which the applicants are possibly interested.
- \* Evaluating and approving this recruitment system from time to time based on the results and feed back.

**Elements of Recruitment :**

Important Elements are :

- (i) Recruitment policy
- (ii) Organisational arrangement
- (iii) Sources of prospectives
- (iv) Preperation for recruitment
- (v) Methods of recruitment

**(i) Development of Recruitment Policy :** Policy is a guideline for decision making. So recruitment policy is a guideline as to how, recruitment function is to be performed. The main purpose of this policy is to see that the actual performance is in agreement with the planned performance. This policy indicates the concern and commitment of the organisation towards several aspects viz., handicaped people, sons-of-soil, minority groups, women, friends and relations of the employees, promotion from within etc. The policy sought to be formulated must help the organisation find and employ the best people, help the internals retain themselves with the organisation, must provide facilities and opportunities for personal growth on the job.

A Recruitment policy can be said to be good when it is :

- \* In compliment with existing public policy and legislation on having and employment aspects the economy.
- \* able in providing needed job security and continous employment,
- \* able to integrate organisational and individual needs,
- \* able to give freedom to utilise and develop skills and knowledge on the job.



- \* able to encourage healthy and responsible trade unions.
- \* able to meet changing needs of the organisation.

### **(ii) Organisational Arrangement :**

Every large sized corporate body now - a-days maintains a seperate dept. by name human resource management dept. personnel management dept. to take up the recruitment activity.

This recruitment organisation can be organised in a centralised manner (or) in a decentralised manner. It is also based on the economics and disecc nimics associated with it. But, in this organisational arrangement, the responsibility to recruit does lie always with the line managers of the departments while, our staff/HR personnel managers do render the necessary assistance in this recruitment activity.

**(iii) Sources :** Principally, there are internal and external sources from which, the desired people can be drawn. Again, it is also a matter of policy. Much debatable issue it is.

#### **(a) Internal Sources :**

**They may include :**

- i) Present employees
- ii) Retired and retrenched people that like to get back,
- iii) Dependents and relatives of the diseased people,
- iv) Transfers and promotions into, etc.

#### **Advantages :**

- \* Morale and motivation are high.
- \* Personnel Turnover is contained.
- \* It promotes loyalty and committment.
- \* Less costly.
- \* Good relations between organisation and trade union are developed.
- \* It is a good retention policy with regard to talented personnel.

#### **Disadvantages :**

- \* Newness and modern dynamism may not be available in the internals.
- \* The supply of fully developed personnel may not be adequate to meet the larger demands of changing environment etc.

#### **(b) External Sources : Advantages :**

- \* Wide supply of Human resources,
- \* Best selection is rendered possible
- \* This source is never exhausted.
- \* It is costly. etc.,

**Disadvantages :**

- \* People take lot of time to get oriented to the organisational climate / culture / environment new
- \* Loyalty is doubtful etc.

**(iv) Preparation for Recruitment :** This is all about Job Specifications in Job Analysis. These specifications may be :

- Physical - Mental - Emotional and Social - behavioural.

This is due to the fact that people recruited and selected must have to ultimately match with job demands. These Job demands may be about the above several aspects.

**(v) Methods of Recruitment :**

Possibly, all methods come classified as :

- \* Direct Methods
- \* Indirect Methods
- \* Third Party Methods

**(a) Direct Methods :** These Methods include sending recruiters to educational and professional institutions, employee contacts with public, manned exhibits, waiting lists etc.

**(b) Indirect Methods :** These are recruiting through advertising in News papers, T.V., Radio, in trade and professional Journals etc.

**(c) Third Party Methods :** These methods use various agencies for the purposes of recruitment. They may comprise of : Pvt. employment exchanges, state agencies, placement offices of schools / colleges / universities, professional associations, recruiting firms, management consulting firms, friends, relatives, indoctrination seminars for college / university professors, trade unions, temporary help agencies, casual labour, deputations etc.,

Thus, Recruitment is to create a big pool of eligible recruits, giving rise to the other managerial function - selection.

**Recruitment practices in India :** Indian industries mostly depend upon the following practices.

- \* Internal sources
- \* Public (or) Government Employment exchanges
- \* Campus Recruitments
- \* Advertisements
- \* Executive search agencies
- \* Contractors
- \* References made by the existing people etc.,

**9.4.4. Selection :** This managerial function begins where recruitment ends. Selection is all negative while recruitment is all positive. "Selection is the process of examining the applicants with regard to their suitability for the given jobs and choosing the best from the suitable candidates and rejecting the others." It is then an activity of picking and choosing the best from a big pool of eligible recruits to suit to the organisational requirements.



**Qualitative and Effective Selection :** Should this selection process be effective and meaningful, the following essentials must be cared for.

- \* There must be standard personality of personnel to be matched with that of the candidates for selection, based on job (or) employee specification supplied by the Job Analysis professionals.
- \* There must be good number of recruits to make the selection better. Supply must be good.

**Selection process :** Since selection is a process of selecting a few and rejecting some of the recruits, several steps (or) stages (or) hurdles are introduced in the selection process. Candidates for selection will be allowed to proceed to the next stage in the selection process, when they are successful in the preceeding stage (or) hurdle. That is why, this method of selection itself is known as "successive hurdles" method. So, a good candidate is one who is successful in all these hurdles. Dale Yoder cited already, calls these hurdles "go, No-go" gauges. The number of hurdles and complexity of selection are very much in proportion to the level of heirarchy and responsibility of the positions for which, this selection function is intended. There are no hard and fast rules that these hurdles shall be arranged in a particular order. Any other order, as a matter of convenience, is suggestible. The relevent figure follows.

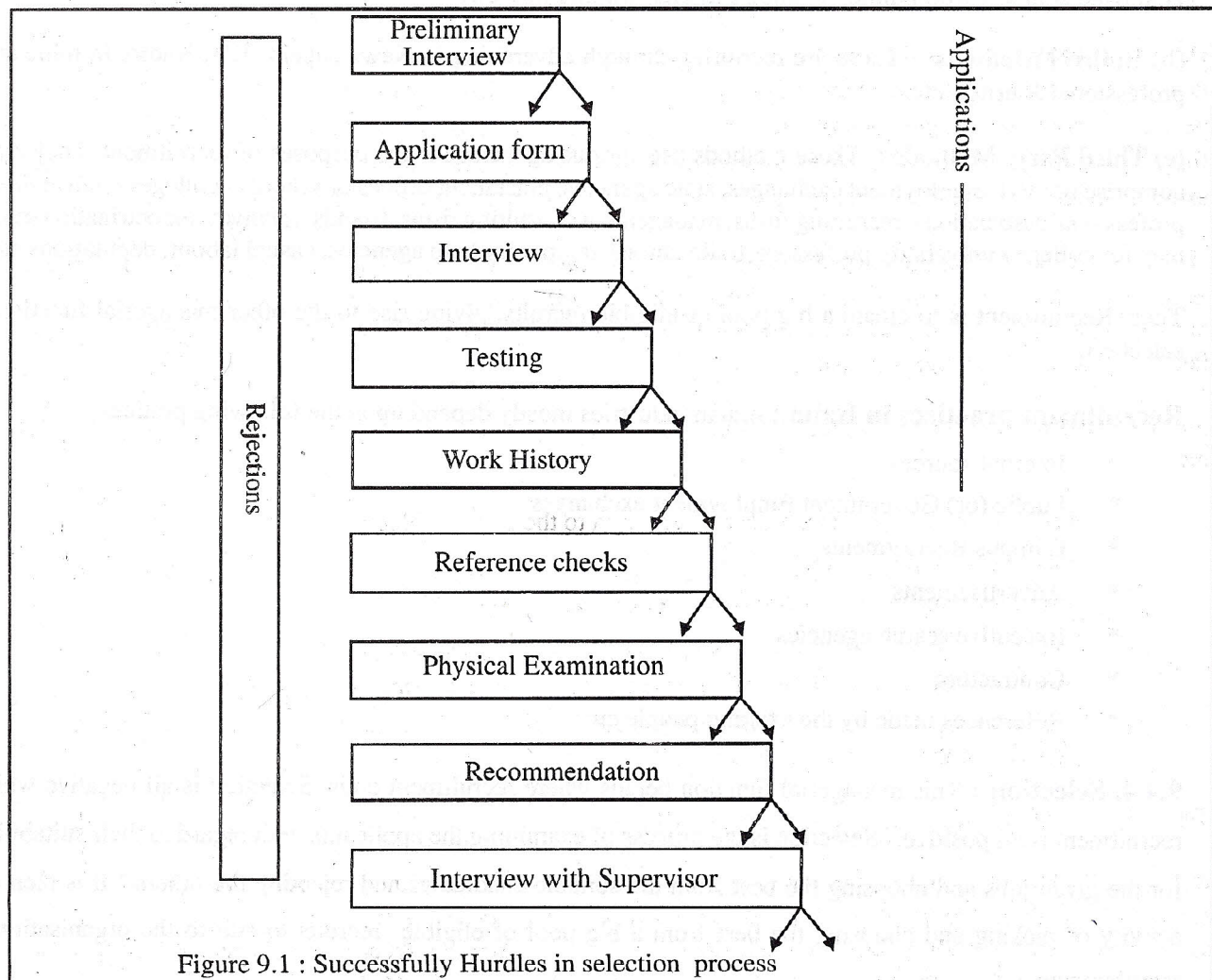

Figure 9.1 : Successfully Hurdles in selection process

**(A) Initial Screening (or) Preliminary Interview :** This is a crude screening process done by a junior executive in an informal way, in which candidates for selection may be informed of the nature of Job and the organization also may get such details as educational back ground, experience if any, expertise, emoluments etc., to find out if the candidate is a suitable one and also to filter the candidates as it is a costly unwanted process to allow all candidates to undergo different stages. The candidate will be given an application form to fill in and submit, if he is suitable to be tried.

**(B) Application form :** There is no any standardized form of application to be used by all in a general manner. This differs from organisation to organisation. This is the medium through which, the candidate has to primarily describe himself about his candidature and suitability to particular job advertised in news papers. Care is to be essentially taken to avoid evidences of any discriminatory attitudes, by designing these application forms, with some reference to nationality, place, caste, religion, place of birth etc.

Application form is known by different names such as Application Blank, Bio-data, Resume, curriculum Vitae (CV) etc. While filling up (or) writing an application for a job, much care needs to be taken by the candidates as insufficiency of information in the application blank may sometimes result in rejection of the candidates.

**(C) Interview :** This is the most significant stage in the entire selection process. It is an oral examination. It is a dramatic scene where there are two important people viz., interviewer and the interviewee. Both are expected to know more about each other. The main purpose is to appraise the personality of the candidates to find out the most suitable. This gives a direct opportunity to see the candidates. It is a lengthy fact finding exercise. Interviews are of several types : Formal, informal, non-directive, depth, stress interviews etc.,

**(D) Tests :** These tests are normally called Psychological tests as Psychologists have contributed these tests in order that the organisations in need of personnel, may be helped to find out the suitable candidates. The purposes for which these tests are employed are many and varied as : Selections, Placement, Promotions, Performance and Potential appraisals.

**Some Guidelines :** Selectively these tests have to be employed as per Dale S. Beach in Personnel Management.

- \* These Psychological tests are only, in addition to the normal selection procedures.
- \* Tests alone do not decide.
- \* To find out candidate's weaknesses, the tests may be used.
- \* Tests shall live up to concepts of testing viz., Reliability and Validity.
- \* Tests can be held in the failure of other procedures for selection.
- \* Much reliance on these tests is not always good, as there can't be any linear / proportionate relation between the test score and Job success.

**Testing concepts :** These are reliability and validity concepts.

**Reliability :** The test administrators have to make it sure and certain that their test is a reliable one, before it is employed. Reliability is with regard to the level / degree of consistency of test score obtained throughout series of measurements. If the person obtains same result repeatedly, the test can be considered reliable. Dale S. Beach opines that the reliability Co-efficient should be between + 0.85 and + 1.00



**Validity :** A test is said to be valid when it is able to measure what it is supposed to measure.

Eg. An intelligence test is valid test when it is really able to measure the level of intelligence.

**Types of Tests :**

- (a) Intelligence Tests    (b) Potential Ability Tests  
 (c) Personality Tests    (d) Interest Tests  
 (e) Simulation Tests    (f) Integrity Tests

**(a) Intelligence Tests :** These tests seek to measure the knowledge acquired by virtue of a training and development programme and by the job experience also. Here, there are two types.

**(i) Trade Tests :** This seeks to verify the level of knowledge of the candidate in using type writers, calculators, other small mechanical equipments like computers etc. These are mostly oral.

**(ii) Work Sample Tests :** Sometime, a candidate may be given a sample of a real piece of work to be done. He and his performance are observed while he is on the Job. Thus, candidates are tested.

**(b) Potential Ability Tests :** These tests unearth the hidden talents / skills like reasoning and mechanical (or) musical aptitude. These are several types.

**(i) Mental Tests :** Intelligence quotient is sought to be measured which may help us in knowing whether the person in question has mental capacity to deal with any new problem. They may also determine fluency in language, memory, speed of perception etc.,

**(ii) Mechanical Aptitude :** Specially, these tests are employed to select people (apprentices, maintenance workers, mechanical technicians etc.,) who are good at learning particular mechanical work.

**(iii) Psychomotor Tests : (Skill Tests) :** These are employed to examine mental dexterity (or) motor ability, to select workers, to take up semi skilled, repetitive jobs like assembly work, packing, testing etc.

**(c) Personality Tests :** Since Personality is influenced by several variables, people use these tests to detect some important traits. The Job performance may be effected by traits like Self confidence, optimism, sociability, sympathy, integrity, conformity, objectivity, patience, stability etc, Types of these tests are as under. These are used to select mostly managerial personnel.

**(i) Objective Tests :** They seek to find out neorotic tendencies, dominance, self confidence etc.,

**(ii) Projective Tests :** These tests measure the trend and line of thinking of candidates for selection for a particular aspect. The thought (or) idea expressed is always based on the names and personality of the individual.

**(iii) Situation Tests :** These tests observe the behavioural aspects of people, in varied situations, created in the tests.

**(d) Interest Tests :** This seeks to know about the inventory of likes and dislikes of the candidates.

**(e) Simulation Tests :** Sometimes, for selecting and offering training to some candidates, people are exposed to a closely duplicated environment (or) mechanical equipments. In this simulated atmosphere, the candidates are tested. This is mostly used for managerial level personnel.

**(f) Integrity Tests :** This is very much self explanatory. These tests find out the degree of integrity on the part of candidates.

**(i) Formal Interview :** It is completely structured, planned, programmed etc., Every inch of this programme is scheduled. Accordingly, things take place as per that understanding reached. In most of the Govt. sector companies and Pvt. sector also, this is the most prominent type.

**(ii) Informal Interview :** This interview is very casual and not structured and planned in any manner. It is less serious one. No rules and regulations are there to be followed.

**(iii) Non -directive :** The interviewer doesn't give any direction about what the candidate has to express. Instead of that, he is left free to talk about anything in which, he is interest. Interviewer is only a silent patient listener only. This is designed to let the interviewer speak out freely.

**(iv) Depth Interview :** It is very much self explanatory. Based on the application blank and claims made there, the interviewer goes deep into that subject and measures the depth of knowledge.

**(v) Stress Interview :** This is a special type of interview as it has a special purpose to be met. The purpose of this is to find out a candidate who is able to withstand all stresses and strains, ups and downs of a particular job. So, the model of interview also is slightly different. The candidate is disgusted upto the maximum possible extent with all silly and non-sensical questions.

**(E) Reference checks :** This is one of the steps in the selection process. It is an important source of information by which, background information can be had from the colleges (or) schools where the candidates got education previous organisations, some officials known to him etc. A great deal of information about the real personality aspects of the person in questions can be had by this. That is why, the candidates are expected to give two reference names in the application blank.

**(F) Physical Examination (Medical) :** The last but one stage is this medical examination when a person is successful in all the preceding stages, he will be sent for this hurdle as physical fitness also is equally important aspect.

**Objectives sought to be met are :**

- Fitness of the candidate to the Job
- Discovering the disabilities if any
- Preventing from the employment of people suffering from some contagious diseases etc.

**Medical Checkups may include the following :**

- Medical history
- Measurements viz., hight, weight, etc
- Special senses - visual and auditory activity.
- Clinical Examination : eyes, ears, nose, throat etc.,
- Examination of chest and lungs
- Blood - Pressure, examination of urine and boold, etc.,

**(G) Final Selection Interview :** This is the real last step in the selection process ladder. This interview is with the supervisor (or) the manager under whom he has to work. This step strengthens the relations between



superior and subordinate. Since the candidate is a successful one in the preceding hurdles, he is formally selected in this stage.

There, the selection leads to employment finally.

**9.4.5. Placement And Probation :** When the selection process is completed, people are said to be employed (or) appointed. Thus, when a candidate comes to the manager (or) the supervisor, the obligation of the supervisor is to place him on the right job for which he has been selected and he is very much suitable. The immediate Job is that the candidates may be kept on probation the period of which may be ranging from 6 month to 2 years. In this probationary period, the candidates may be offered training on several related jobs. The final placement decision is taken on the basis of the initial training received by the trained candidates. If the performance in training period (or) probation period is not upto the mark of satisfaction of the manager (or) the supervisor, the candidate may be expected to quit the job. If his performance is excelent, his service gets regularised. Thus, there are placements made on the basis of the performance in the training period.

**9.4.6. Induction (or) Orientation :** This is a simple but very important pleasant job to be performed. This is introducing the freshers to the organisation, members, superiors, peers, department, products, every inch of the organisation, culture of the orgnisation, rules and regulations etc., The main purpose of this pleasant exercise is to see that the freshers do not feel that they are quite new and strange to the environment. Need for this arises due to the idea that there is labour turnover at a high level when the people in the orgnisation are not able to get acquainted with the organisation and environment to the organisation. New comers feel insecure nervous, hesitant etc., to work for the organisation. So, some informal (or) formal arrangement is necessary to see that these freshers / new recruits are at home.

Normally, companies do not give much importance to this assuming that it is an automatic activity that the seniors perform this. The main purpose is to "sell" the company to the new employees so that they may feel proud of their association with the company.

A good programme should cover the following.

- ◆ The company, products, history,
- ◆ Significance of the products of this company
- ◆ Organisation chart / structure
- ◆ His own dept. and his own job
- ◆ Policies, rules and regulations,
- ◆ Terms & conditions of service
- ◆ Promotional opportunities
- ◆ Grievance procedures
- ◆ Social benefits
- ◆ the organisation totally etc.,

It may be done by the staff in general and specifically, it may be given by the supervisor also.

**9.5. Summary :** Staffing is normally called human resource management. It is primarily concerned with human resource planning, job analysis, recruitment, selection, training and development, wage and salary administration, performance appraisal etc. the main purpose of Staffing is to equip the corporate body with the best human resources to help it accomplish organisational goals. The slogan Right men for the Right job, is accomplished when, Staffing function is effectively performed. Sometimes, in management parlance, this staffing is not separately dealt with and it is made a part of organising managerial function.

### 9.6. Key Words

1. **Staffing :** Staffing is filling and keeping filled positions in the organisation structure.
2. **Human Resource Planning :** It is the process of getting the right number. of people qualified to suit to the jobs at the right time.
3. **Recruitment :** It is the process of searching for prospective employees and stimulating them to apply for jobs in an organisation.
4. **Selection :** It is the process of examining the applicants with regard to their suitability for the given jobs and choosing the best from the suitable candidates and rejecting the others.
5. **Induction (or) Orientation :** This is introducing the freshers to the organisation, members, superiors, peers, departments, products, every inch of the organisation, culture of the organisation, rules and regulations, etc.

### 9.7. Self Assessment Questions :

1. What do you mean by recruitment? what sources do you prefer? Why?
2. Recruitment is positive and selection is negative. Discuss

### 9.8. Further Readings :

- \* Personnel / Human Resource Management, Keith Davis
- \* Personnel / Human Resource Management, Gary Dessler
- \* Personnel / Human Resource Management, VSP. Rao and PSP. Rao
- \* Management, Text and cases, VSP, Rao, Hari Krishna

**Dr. G. Satyanarayana**



# TRAINING AND DEVELOPMENT

**Objectives :** This lesson is seeks to help you learn :

- concepts : training, development
- differences
- importance of training/development
- methods of training and development
- evaluation of training

**Structure :**

- 10.1 Introduction
- 10.2 Training Vs Development
- 10.3 Training/Development and Learning
- 10.4 Importance
- 10.5 Advantages
- 10.6 Essentials
- 10.7 Methods of Training
- 10.8 Training Evaluation
- 10.9 Management Development
- 10.10 Summary
- 10.11 Key words
- 10.12 Self Assessment Questions
- 10.13 Further Readings

## 10.1 Introduction

In earlier sections, it has been understood that the freshers after being selected, placed and introduced to the fellowmen and the organization, are now ready to take up the jobs or assignments for which they have been employed (or) selected. But, the real personality of the incumbent is not very much in agreement with the standard personality that the incumbent should have to give an expected job performance. Keith Davis is of the opinion that this gap is sought to be filled up with some additional inputs of knowledge, skill and behavioural aspects by way of training and development. The following figure describes the need for training development best.

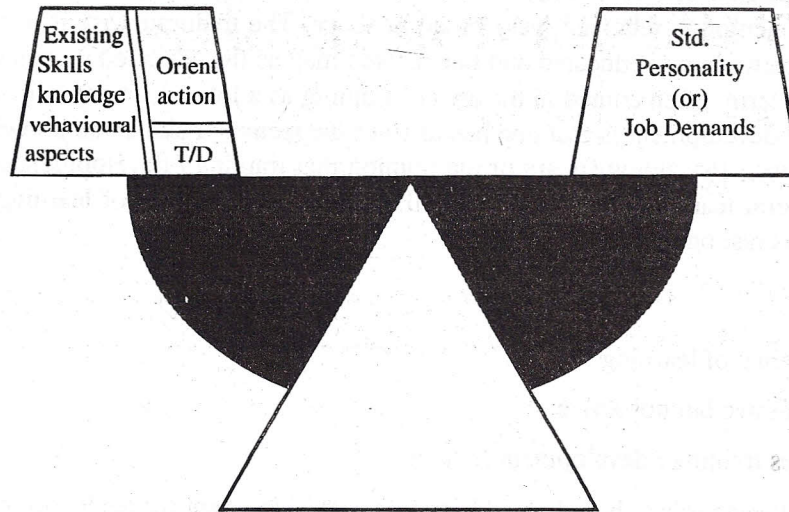

Source : Keith Davis, Personal / Human Resource Mgt.p. 282

**Training and Development :** For describing the differences and knowing the two concepts better, the following definitions will be of some help.

**Training :** Dale S. Beach defines training as that it is an organized procedure, by which, people learn knowledge and skill for a definite purpose. As per writers of IGNOU; Training is a short term process, utilising a systematic and organised procedure, by which, non-managerial personnel, acquire technical knowledge and skill for a definite purpose.

**Development :** It is a long term educational process utilising a systematic and organised procedure, by which managerial personnel get conceptual and theoretical knowledge (IGNOU)).

The main purpose of both these concepts is one and the same . The main difference is only about organisational levels, contents, methods employed etc.

**10.2. Differences between Training and Development**

Areas	Training	Development
Inputs	Technical Skills & Knowledge	Behavioural aspects, Educational, Conceptual, Philosophical, Theoretical etc.,
Purposes	Job oriented	General Knowledge
Period	Very short period, Terminal point is there	Eternal, Long term, no any Terminal point etc.
Mostly for whom	Non-managerial personnel	Managerial personnel



**10.3. Training Development and learning :** Since there is already acquaintance with the concept training, repetition is avoided. Education is relatively very broad in scope. The main purpose is to see that there is a fundamental difference between any educated and uneducated man as the educated person only lives the life best. Learning is another term, often coined in the area of training as a lot of learning is involved in training. Integral part of training / development is that one has to learn the technical skills and knowledge and several desired behavioural patterns. Psychologists are of the opinion that training / development is almost learning and hence, there are several learning principles that will accelerate the process of learning, if the training / development programmes rest on these.

**Learning principles :**

- ❖ Person is capable of learning
- ❖ Learning is passive but not active
- ❖ Practice makes training / development perfect
- ❖ Knowledge of standards to be achieved in training / development makes learning fast
- ❖ Learning is fast when learners learn at their pace
- ❖ One should shed half knowledge to make learning fast
- ❖ Learners need reinforcement of behavioral patterns
- ❖ In case of complex skills, Learning occurs at a lower speed
- ❖ To make learning fast, methods of teaching and educating must vary, lest, they should get disgusted / bored.

**10.4 Importance of Training/Development :** The simple point of commonsense is that no organisation gets a candidate who exactly matches with the job demands and organizational requirements. Hence, training is needed.

- ⊙ Modern organisations are never worried about some work (or) Job performance. They are very much worried about effective and efficient Job work.
- ⊙ Fast changing Environment and technology compells orgnizations to equip their people with uptodate skills, lest, people should meet risk of obsolescence at the earliest.
- ⊙ When people have be rotated and need to be upgraded, they need T/d. Thus, the events that give rise to traning and development, will be many and varied.

**10.5. Some Important Promised Benefits :**

- ⊙ Improved profitability
- ⊙ improvement in knowledge and skills at all levels of the heirarchy
- ⊙ aids in the organizational development
- ⊙ reduction wastes & spoilages
- ⊙ betterment in the methods / processes of work
- ⊙ Sign of relief to the supervisors

- ⊙ drastic reduction in the number of accidents and machine break downs
- ⊙ improvement in quality and quantity of output
- ⊙ reduction in manpower obsolescence
- ⊙ personnel growth and advancement
- ⊙ improves labour management relations etc.

**10.6. Essentials of a Good Training Programme :** Managers incharge of training must care for the following aspects, should any Training programme be meaningful and productive.

10.6.1. Creating an organisational arrangement.

10.6.2. Assessment of training needs, and

10.6.3. Planning and evaluating the Training programme.

**10.6.1. Organisation for training :** definitely, it is not the job of a single person (or) a department. In a large sized organisation, it is the responsibility of many more people in the organisation. It is shared among top management, personnel dept., supervisors and the trained candidates. Broadly all policy frame work is the responsibility of the top management while personnel Department and supervisors do implement the policy frame given to them by the top people and the trainees will give feed back to their trainers and higher ups to assess the effectiveness Thus, an organisational arrangement is made.

**10.6.2. Assessing Training needs and Methods thereof :** The basic assumption underlying the training activity any where is that it is need based and problem oriented. A three step procedure has been advocated by Michael Jucius J.

- (i) organizational analysis which lets one know of the important area that need stress and emphasis for training purposes.
- (ii) Operation's Analysis to help one identify the actual requirement of training to make the trainee employees perform the operations better.
- (iii) Man analysis is the Analysis of people to be trained.

**Methods to identify the training needs are :**

- (a) interviews with personnel
- (b) performance appraisals
- (c) personal observations
- (d) personnel records
- (e) by constituting special committees
- (f) analysis of problems
- (g) incident pattern
- (h) skills inventory etc.,



### 10.6.3. Planning and evaluating training programme : (Steps)

(a) *An important step in planning is development of following objectives of training :*

- ⊗ to help employees do their 1st appointment job, on transfers, on promotions etc,
- ⊗ to help them put in better performance
- ⊗ to help them take up future jobs
- ⊗ to develop a second line of defense.

(b) *Another important step is formulation of a training policy to answer the issues viz.,*

What is sought to be achieved by training?

What are training priorities?

At what cost?

Where should the training be offered?

Who is responsible for training?

How much should trainees be paid in training period?

What external agencies should be associated with?

How long and frequently should it be?

(c) *How deep should trainer go?*

This is answered by the following equation.

$$\boxed{\text{Training need}} = \boxed{\text{What must be earned?}} - \boxed{\text{What has been learnt already.}}$$

(minus)

Thus, the gap is to be identified and the training should intend to fill up the gap with the training input consisting of skills, knowledge, behavioral aspects etc.

(d) *selecting trainees, trainers and venue for training :*

Sometimes, trainers may be internally available. In case of non-availability, sometimes are to be established with external instructors and outside training agencies.

(e) *Evaluating Part :*

It is all about cost-benefit analysis. The training organizers are obliged to verify whether their objectives have been met successfully or not. Appraisal of the training programme may be attempted by comparing post-training scenario with pre-training scenario, with special reference to production, costs, wastages, scrap, accidents, grievances, absenteeism, labour turnover, employee morale etc.,

### 10.7. Methods of Training :

The following are some important methods

- (i) On the Job training
- (ii) Vestibule Method / Training Centre Training
- (iii) Apprenticeship Training/Internship
- (iv) Programmed learning
- (v) Simulation

- (vi) Coaching
- (vii) Job Rotation
- (viii) Job instruction method
- (ix) Demonstration

#### **10.7.1. On the Job Training/Job Instruction Training/demonstration / Coaching :**

- \* Most commonly used method
- \* Training is imparted on the Job itself
- \* He learns the Job which he is on
- \* It requires no separate school as such
- \* Tg. is offered by the senior most man (or) supervisor
- \* The coach (or) the demonstrator first does the Job before the trainee.
- \* He is given all instructions about the Job to be done
- \* He expects the trainee to do the Job by closely imitating the demonstrator
- \* He guides the trainees till the trainee learns it best.
- \* There is feed back and follow up.

#### **This method to be successful depends upon :**

- \* good coaches / demonstrators
- \* clear instructions
- \* good feed back

#### **10.7.2. Vestibule / Training centre Training**

- \* It is also a type of on the Job training.
- \* It is not within the organisation
- \* It is in a separate training institute.
- \* The materials (or) the equipment used is no different from the ones used in the real organisational setting.
- \* Training on a typewriter for a typist and on a computer for a computer programmer, can be cited as examples.

#### **10.7.3. Simulation Method :**

- It is also another variant of on the job type.
- It is an extension of vestibule training.
- Trainee is offered training in closely duplicated real job conditions.
- This is resorted to when the actual on the job training is expensive and hazardous, and when any error may result in human loss (or) destruction of invaluable material resource



Eg. : Training to an air - pilot, on a duplicated real air craft

#### 10.7.4. Apprenticeship Training Method : It is also known as Internship.

- This is the oldest form of training method.
- Each apprentice is given a programme of assignments as per a predetermined schedule which may provide for an efficient training in trade skills.
- This is mostly suitable to crafts, trades and technical areas where proficiency on a job is in proportion to length of time involved.

Eg. : Job of a craftsman, a machinist, a printer, tool maker, pattern designer, mechanics etc.,

- Some times, companies and the colleges / schools jointly enter into schemes of this kind.
- Some times, these trainees stand a chance of being absorbed in the very same company that offers this apprenticeship training.
- The apprenticeship period may range from 3 to 12 months (or) it may also range from year to 4 years also.
- The apprentice act of 1961 requires some specified industrial units to provide training in basic skills and knowledge in some specified trades to educated unemployed, to enhance the employability of these people.

#### 10.7.5. Job Rotation :

- This is also one type of training on the job category.
- One special purpose may be to provide for a second line of defence
- Another purpose is to see that the inherent monotony (or) disgust on a job is minimised.
- Still a different purpose is to make people Jacks of all trades but master of none, as the underlying logic is that people in an organisation should know something of every job / trade.
- With these ideas, employees are rotated from one Job to another Job.
- In this process, when a person is on a job for training purpose for some time, all methods seen till now may be made applicable.
- Thus, Job rotation method works.

**10.8. Evaluation of Training Programme :** The specification of values forms a basis for evaluation. The basis of evaluation and the mode of collection of information necessary for evaluation should be determined at the planning stage. The process of training evaluation has been defined as "any attempt to obtain information on the effects of training performance, and to assess the value of training in the light of that information. Evaluation leads to controlling and correcting the training programme. Hamblin suggested five levels at which evaluation of training can take place, viz., reactions, learning, job behaviour, organisation and ultimate value.

- (i) **Reactions :** Training programme is evaluated on the basis of trainee's reactions to the usefulness of coverage of the matter, depth of the course content, method of presentation, teaching methods etc.
- (ii) **Learning :** Training programme, trainer's ability and trainee ability and trainee are evaluated on the basis of quantity of content learned and time in which it is learned and learner's ability to use or apply, the content he learned.

- (iii) **Job Behaviour :** This evaluation includes the manner and extent to which the trainee has applied his learning to his job.
- (iv) **Organisation :** This evaluation measures the use of training, learning and change in the job behaviour of the department/organisation in the form of increased productivity, quality, morale, sales turnover and the like.
- (v) **Ultimate Value :** It is the measurement of ultimate result of the contributions of the training programme to the Company goals like survival, growth, profitability etc., and to the individual goals like development of personality and social goals like maximising social benefit.

**Essential Ingredients for a Successful Evaluation :** There are three essential ingredients in a successful evaluation. They are : (i) Support throughout the evaluation process. Support items are human resources, time, finance, equipment and availability of data source, records etc. (ii) Existence of open communication channels among top management, participants and those involved in providing data etc., and (iii) Existence of sound management process.

**Basis of Evaluation :** Training programme can be evaluated on the basis of various factors like production factor, general observation, human resource factors, performance. tests, cost-value relationship etc.

**(a) Production Factors :** In operative training, the prime measure of worth is that of productivity. Productivity rates covering both quantity and quality are good indicators of the values of training. In most business situations these rates will have to be obtained before and after training. In an experimental situation, a control group that does not receive training could be compared with the one that does in order to ascertain the effect of training. Management will generally look first at production and wastage rates to determine the worth of operative training. The other production factors are to decrease in unit time and unit cost of production and reduction in space or machine requirements.

**(b) General Observation :** General observation should not be overlooked as a means of training evaluation. The immediate supervisor is often a good judge of the skill level of his subordinates. For on-the-job training programmes, the supervisor is, in effect, the judges of his or her own efforts. If the supervisor is treated as a part of the professional management of the organisation and is properly selected and trained, this self-analysis and appraisal can be quite accurate and objective. The efficient supervisor observes accurately the level of skill and knowledge acquired by the trainee during the traing programme. He also observes how effectively the trainees apply the acquired skill and knowledge to the present and future jobs.

**(c) Human Resource Factors :** Training programme can also be evaluated on the basis of employee satisfaction which in turn can be viewed on the basis of :

- (i) Decrease in employee turnover.
- (ii) Decrease in absenteeism.
- (iii) Decrease in number and severity of accidents.
- (iv) Betterment of employee morale.
- (v) Decrease in grievance and disciplinary cases.
- (vi) Reduction in time to earn piece rates.
- (vii) Decrease in number of discharges or dismissals.



**(d) Performance Tests :** In the immediate sense, the specific course of training can be evaluated in terms of written and performance tests. The test is supported by a sample of what the trainee knows or can do. Successful accomplishment of the tests would indicate successful training. But the true test is whether or not what has been learned in training is successfully transferred and applied to the job. It is dangerous to rely upon tests alone to demonstrate the true value of training. Performance appraisal on the job before and after training may be supplemented to the tests.

**(e) Cost - Value Relationship :** Cost factor in training should be taken into consideration in evaluating the training effectiveness. Cost of various techniques of training and their value in the form of reduced learning time, improved learning and higher performance can be taken into account. Cost of training includes cost of employing trainers, and trainees, providing the means to learn, maintenance and running of training centres, wastage, low level of production, opportunity cost of trainers and trainees etc. The value of the training includes increased value of human resources of both the trainee and trainer and their contribution to raise production, reduce wastage, breakage, minimisation of time requirement etc. Cost-value relationship of a training programme or a training technique is helpful in: (a) determining the priorities for training (for present and potential managers, age structure of the trainees etc.), (b) matching the employee and job through training, (c) determining the work of management sacrifices (like: time taken by training programme, non-availability of staff for production during training period etc.,) (d) Choosing the right training method.

Any one of the possible combination of the methods of training evaluation listed below can be used by an organisation for evaluation depending upon the need and convenience. The various methods of training evaluation are :

- (i) Immediate assesment of trainees' reaction to the programme.
- (ii) Trainees' observation during training programme.
- (iii) Knowing trainees' expectations before the training programme and collecting their views regarding the attainment of the expectations, after training.
- (iv) Seeking opinion of trainee's superior, regarding his / her job performance and behaviour before and after training .
- (v) Evaluation of trainee's skill level before and after training programme.
- (vi) Measurement of improvement in trainee's on the job behaviour.
- (vii) Examination of testing system before and after sometime of the training programme.
- (viii) Measurement of trainee's attitudes after training programme.
- (ix) Cost-benefit analysis of the training programme.
- (x) Seeking opinion of trainee's colleagues regarding his/her job performance and behaviour.
- (xi) Measurement of levels in absenteeism, turnover, wastage/scrap, accidents, breakage of the machinery during pre and post period of the training programme.
- (xii) Seeking opinions of trainee's/subordinates regarding his / her job performance and behaviour.

**Feedback :** Training evaluation information should be provided to the trainer and/or instructors, trainees and all other parties concerned for control, correction and improvement of trainee's activities. Further, the training evaluator should follow it up to ensure implementation of the evaluation report at every stage. Feedback information can be collected on the basis of questionnaire or through interview.



### 10.9. Development / Management Development / Executive Development

Organisational growth is very good function of management development. Which is wedded to the development of managerial personnel at all levels of the organization. Industrial society is badly in need of several professionals and fully developed managers. If the managerial personnel are not developed in larger number and on qualitative lines in this competitive world, the industrial organizations have to collapse and go out of industrial map. Hence, there is need for managerial development. From the foregoing, it can be easily understood that training is needed not only for non-managerial personnel but also for managerial personnel. Here, the concept - "Training" used in the case of training the managerial personnel is no different word from the concepts such as managerial development (or) executive development. Hence, development, Managerial Development, and executive development are all one and the same.

#### 10.9.1. Objectives of Managerial Development

- to improve the performance of managers
- to supply required potential candidate for senior positions
- to increase motivational and morale aspects of the organization
- to develop problem solving and decision making skills
- to supply a large supply of managerial personnel to the society to help the economy develop
- to understand human problems and develop human relations
- to stimulate creative thinking
- to postpone managerial obsolescence etc.

#### 10.9.2. Methods / Techniques for developing managers

- |   |                          |
|---|--------------------------|
| (i) Job rotation                          | (vii) In basket exercise |
| (ii) Creation of "Assistant to" positions | (viii) Incident method   |
| (iii) understudy                          | (ix) Simulation          |
| (iv) Temporary promotions                 | (x) Multiple Management  |
| (v) committees & Jr. Boards               | (xi) Role playing        |
| (vi) Case method                          | (xii) Conferece Training |

**(i) Job Rotation :** By this time, job rotation is no foreign term to you. You must be already familiar with it. It is moving from one job to another to know something about different Jobs. This is of defferent kinds.

**a) In observation assignments :** Management trainees are given an opportunity to observe a set of departmental managers and to get themselves acquainted with those managers for understanding various managerial problems and their solutions. Thus, the trainees are afforded an opportunity to learn.

**b) Among managerial training positions :** There are some positions called as "training managerial positions", which are filled up with these trainee managers. The mission is to give actual supervisory experience in a variety of positions.

**c) Middle level Rotation in Assistant Position :** Trainee managers are shuffled as assistant managers in several department to widen their experience.

**d) Un-specified Rotation among managerial positions :** This is aimed at giving managers responsible experience in veriety of positions.



**(ii) Creation of "Assistant To" Position :** In most of the managerial positions, there is a small provision like, "Assistant To" category. This "Asst.To" is a trainee manager. The boss (or) the superior is the trainer, mentor, Judge, coach, guide etc., to the "Asst. To". Hence, the superior is a big school of learning to the "Asst.To"

**(iii) Under study :** An under study candidate is a trainee manager selected specially for a purpose. The purpose is to keep the under-study candidate as future fulfilled candidate. So, presently, he is kept under the study of a senior manager who is likely to retire (or) be away from the organization for a while. So, in the place of that senior man, this "Understudy" candidate is going to be placed. So, presently, as a management trainee, the understudy candidate is expected to perform some of the important activities that the senior people would have to perform in the normal manner.

**(iv) Temporary promotions :** Some times, the trainee managers may be offered some temporary promotions and may be placed in higher positions : they will be also made accountable for their decisions, during that temporary tenure Thus, managers are trained.

**(v) Committees and Jr. Boards :** This is a special arrangement. These committees and boards consist of middle level managers as trainees, selected on the basis of merit. They act as idea men. As responsible executive will be monitoring the working of the boards, their actions, decisions, proposals etc. will be reported to top, if found suitable. Thus, management trainees are trained and developed.

**(vi) Case Method :** This is an excellent method to develop problem solving and decision making skills in managers. In this method, cases, actual (or) hypothetical are given to trainee managers and are asked to involve themselves deeply with those cases, incidents (or) events to identify the real problem, analyse the situation of that case/ event/incident and offer the best possible solution after identifying all possible solutions. Some times, the trainees may have to find out whether the decisions taken in those cases are right (or) wrong. Thus, they are exposed to analytical, problem solving and decision skills. Besides this, they learn open mindedness, patient listening, respecting the views of others etc., as these are very much required on the part of managerial personnel.

**(vii) In Basket Exercise :** This is a peculiar method. It is a little bit simulation model. The Management trainee is exposed to a desk and a good variety of immediate/urgent problems in his "in Basket". His response reaction, and decisions to this "in basket", are judged by a team of experts who will be critically observing sitting at a distance. Thus, trainees are expected to step into the shoes of some managers for a while for training purposes. Thus, there is lot of similarity and duplication in the methods used for training and Management Development.

**(viii) Incident Method :** This method was developed by Paul Pigors. It aims to develop the trainee in the areas of intellectual ability, practical judgement and social awareness. Under this method each employee is developed in a group process.

Incidents are prepared on the basis of actual situations which happened in different organisations. Each employee in the training group is asked to study the incident and to make short-term decisions in the role of a person who has to cope with the incident in the actual situation. Later, the group studies and discusses the incident and takes decisions relating to incident, based on the group interaction and decisions taken by each member. Thus, this method is similar to a combination of "case method" and "in basket" method.

**(ix) Simulation :** Under this technique the situation is duplicated in such a way that it carries a closer resemblance to the actual job situation. The trainee experiences a feeling that he is actually encountering all those



conditions. Then he is asked to assume a particular role in the circumstances and solve the problems by making a decision. He is immediately given a feedback of his performance.

One of the limitations of this method is that it is very difficult to duplicate the situation to the extent of making the trainee feel the pressures and realities of actual decision-making on the job. The very fact that the trainee knows that it is an artificial situation prevents him from experiencing all that he experiences in real job situation.

**(x) Multiple Management :** Multiple management is the name given to the system whereby permanent advisory committee of executives study problems of the organisation and make recommendations to higher management. The final decision rests with the higher management. Thus committees are the device for executive development. Another device is the establishment of a junior board of directors in a company for the training of the executives. The junior board is given the power to discuss any problem which the senior board constituted by the shareholders. The greatest value of this additional board is the training of junior executives. Memberships on the Junior board becomes a pre-requisite to the membership of the senior board.

The junior board discusses a wide variety of subjects which a senior board can discuss. All recommendations that are forwarded to the senior board must be unanimous. This will prevent the lower boards from dumping their problems upon the senior board. The senior is under no compulsion to accept the recommendations of the junior board. The senior is under no compulsion to accept the recommendations of the junior board. The junior board and various committees serve in an advisory capacity only. Though the major objective is training and development of junior executives, the company is benefited by their productive ideas.

As a management development technique, multiple management has several advantages. Firstly, it gives board members an opportunity to gain knowledge and experience in various aspects of business. Secondly, it helps to identify those who have good executive talent. Thirdly, the junior executives gain practical experience in group decision making and in team work. Through the group interaction process, they learn to respect the views of their associates. Lastly, it is a relatively less expensive method of development and it permits a considerable number of executives to participate within a reasonable period of time.

**(xi) Role Playing :** Role playing technique is used for human relations and leadership training. Its purpose is to give trainees an opportunity to learn human relations skills through practice and to develop insight into one's own behaviour and its effect upon others. Thus its objective is very narrow i.e., increase the trainee's skill in dealing with others. It can be used in human relations training and sales training because both these involve dealing with other people.

Under this method, a conflict situation is artificially constructed and two or more trainees are assigned different roles to play. No dialogue is given before hand. The role player are provided with either a written or oral description of a situation and the role they are to play. After being allowed sufficient, time to plan their actions, they must then act and play their roles spontaneously before the class. For instance, a role playing situation may be a supervisor discussing a grievance with an employee or a salesman making a presentation to a purchasing agent.

Role playing has a number of advantages. It provides an opportunity for developing human relations understanding and skills and to put into practice the knowledge they have acquired from textbooks, lectures, discussion, etc. It is learning by doing. The interview may be taped to provide the trainees the feed-back. Thus, knowledge of results is immediate, because the trainees as well as the listeners analyse the behaviour of the role players.

**(xii) Conference Training :** A conference is a group meeting conducted according to an organised plan in which the members seek to develop knowledge and understanding by obtaining a considerable amount of oral



participation. It is an effective training device for persons in the positions of both the conference member and conference leader. As a member, a person can learn from others by comparing his opinions with those of others.

He learns to respect the viewpoint of others and to realise that there is more than one workable approach to a problem. As a conference leader, a man can develop his skills to motivate people through his direction of discussion. He learns the effects of close control and dominating discussion as compared to adopting more permissive type of direction.

Conference method overcomes certain disadvantages of the lecture, because here the participants play very active roles. They are not passive. Learning is facilitated through building upon the ideas contributed by the conference members. In fact, people learn from each other. Interest of the participants tends to be high. The conference is ideally suited to learning part problems and issues and examining them from different angles. It is the best method for reducing dogmatism employed in supervisory and executive development programmes.

**Conference may be of three types :** (i) The directed or the Guided conference : (ii) the consultative conference; and (iii) the problem solving conference. However, the directed conference is most commonly used for training purposes because the programme director has certain concepts which he wishes the trainees to absorb. This device depends for its success upon the active participation of the trainees. The size of the group must be limited to twenty to thirty persons. The people should sit facing one another around a conference table. They should have some knowledge of the subject to be discussed before coming to the programme. The programme co-ordinator introduces the topic and invites viewpoints from the group on problems related to this topic. He must, by skillful use of questions, make sure that the group analyses the topic thoroughly. In the directed conference the leader may introduce new material by occasional brief periods of learning.

The conference method is also not free from drawbacks. The main drawback are as follows : (i) It is limited to a small group and (ii) Progress is often slow because all those desiring to speak on a point are generally allowed to do so. Sometimes, irrelevant issues creep in and the main issue is lost in the process.

**10.10. Summary :** Personnel appointed freshly are never able to actively participative in the organisational activities. There is always a gap of knowledge, Skills etc. between standards expected of the incumbents and the actuals possessed by the candidates. Unless this gap is bridged up with training and development, the gaps remain gaps and there is every possibility that this gap goes wider. There is also risk of the incumbent running the risk of obsolescence. Hence, on the part of non-managers, training is to be planned and development is to be thought of on the part of managerial personnel. Thus, training and development is necessary not only for improving upon the present performance but also for postponing the risk of obsolescence.

#### 10.11. Key words :

1. **Training :** It is an organised procedure by which people learn knowledge and skill for a definite purpose.
2. **Development :** It is a longterm educational process utilising a systematic and organised procedure by which managerial personnel get conceptual and theoretical knowledge.

#### 10.12. Self Assessment Questions :

1. How do you assess the training need of your employees?
2. Why is training and development essential?
3. What methods do you employ for training?
4. Explain some important Management Development methods?

#### 10.13. Further Readings :

- \* Personnel / Human Resource Management : Keith Davis
- \* Personnel / Human Resource Management : Gary Dessler
- \* Personnel Management PSP. Rao and VSP. Rao

# DIRECTION AND MOTIVATION

## Objectives :

This lesson is seeks to help you learn :

- the concept of motivation,
- motivation as a part of direction,
- theory X and theory Y,
- demotivation,
- how to motivate,
- theories on motivation,

## Structure :

11.1 Introduction

11.2 Motivation

11.3 Carrot and Stick Approach

11.4 Theory X and Theory Y

11.5 Intrinsic and Extrinsic Motivation

11.6 Motivation Vs Demotivation

11.7 Importance of Motivation

11.8 How to Motivate?

11.9 What does demoralise?

11.10 Theories on Motivation

11.11 How to Motivate (A Detailed View)?

11.12 Non-Financial Incentives

11.13 Morale and Production

11.14 Summary

11.15 Key words

11.16 Self-Assessment Questions

11.17 Further Readings

**11.1 Introduction :** It is an important managerial function of telling persons about what to do and seeing that they do it to the best of their ability. It is through directing that managers get the work done through people. It consists of :

- issuing orders / instructions
- leading people to achieve organisational goals



- motivating people to put forward the maximum of their efforts
- communicating the information needed by others for goal achievement.

Thus, the scope of directing is very wide which principally may include : motivation, leadership and communication.

**Elements of Direction :** William Newman is of the idea that the following are the elements of directing.

**(i) Good Instructions :** The directions, guidelines, instructions given by the superiors must be complete, clear, reasonable etc. These instructions need to be in written form as possible misunderstandings and confusion about any instruction can be avoided.

**(ii) Follow up of instructions :** A regular follow up and feed back are essential to find out whether the given instructions are getting properly implemented (or) not. From time to time, there must be frequent reviews about the same.

**(iii) Standard practice & indoctrination :** The logic is that there is often misunderstanding due to inadequate direction. So, if the direction practice is standardised, this can be avoided. Indoctrination is instilling belief and confidence into the minds of freshers that they are not freshers and they are to be very much confident of their skills and strengths.

**(iv) Explanations :** While supplying the instructions to the subordinates, boss has to make it clear as to what is the need and reason, for the instructions given to the subordinates.

**(v) Consultative Directions :** It is all joint consultants. Before any thing is finally told to the subordinates, it is expected that the boss should hold a discussion with all concerned and effected people by the proposed direction. If the decision is made with people's involvement, it does not stand a chance of being rejected and not implemented.

Already it has been said that scope of directing includes motivation, leadership and communication, motivation is discussed in the next section. In management literature, directing includes motivation in the first place. To direct means, to motivate, to lead and to communicate.

**11.2. Motivation :** Briefly, management is process of getting things done by the others. So, others should do. Then only management is complete. It is every body's knowledge that people do not do anything unless and untill people intend to work whole heartedly. This working in an organisation whole heartedly has got much to do with our present motivation. We may create a big organisation, hire great and eminent people, provide ultramodern facilities, make it ultimately, an eden on earth but we cannot make people committed, loyal, sincere, truthful and make them have sense of belongingness. This leads one to conclude that there are certain factors that influence people. Motivation is what managers do to induce the subordinates to act in a desired manner. Similarly, motivators are something that induce an individual to work.

**Motivation and Satisfaction :** These two concepts often are misunderstood. Motivation refers to the drive and effort to satisfy a want or a goal, while, satisfaction is the contentment experienced when a want is satisfied. The following figure describes it best.

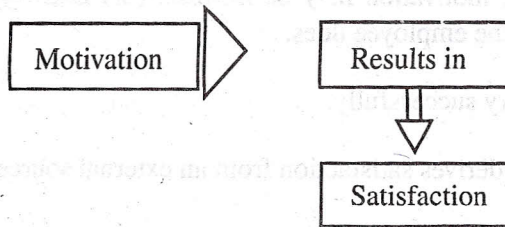

**11.3 Motivation : Carrot and Stick Approach :** The required (or) desired behavioural pattern in the individual can be obtained in a positive or negative manner. If the person responds to positive motivations like: rewards, self discipline, promotions, transfers etc., it is called motivation due to carrots. Similarly, if the needed behaviour in the subordinate is brought about by negative measures like threats, force, compulsions, undue influence, punishments, coercion etc., it is motivation due to stick approach. It is all situational and a combination of the two also may be a good strategy.

**11.4. Theory X and Y theory in Motivation :** Douglas Mc Gregor in his "Human side of the Enterprise", set forth two sets of assumptions about human nature (or) behaviour. The contention of Mc Gregor is that a manager in motivating must have knowledge about these assumptions on human nature (or) behaviour.

There are theory X managers, (also called as auto-craic managers) whose assumptions are at Variance with that of theory Y managers (also called as participative managers). He would not be successful in motivation, if the case is otherwise.

#### Theory X Manager's Assumptions :

- \* There is an inherent dislike, among average persons, for work and will to avoid work if possible.
- \* Hence, to make them put maximum effort towards goal achievement, they need to be coerced, monitored, forced, unduly influenced etc.
- \* On an average, people prefer to be directed, to avoid responsibility, to have only little ambition, and want always security to all others

From the above, one can easily understand that the superior should definitely be an autocratic manager to motivate the subordinates, in an autocratic/despotic/undemocratic manner, as the mission of management is achievement of organisational goals.

#### Theory Y Managers :

- \* Work is as natural as play (or) rest
- \* the degree of commitment to the objectives is in proportion to the size of the rewards associate with the achievement.
- \* All people are creative and imaginative.
- \* People are self disciplined.

When people's nature is like this, superior to motivate need not be autocratic and by being democratic, he can woo the subordinates.



**11.5 Intrinsic and Extrinsic Motivations :** Sometimes, motivation may be intrinsic (or) Extrinsic. Motivation is intrinsic when it is derived from the very Job that the employee does.

Eg. : A Surgeon derives satisfaction when he conducts the surgery successfully.

Similarly, Motivation may be extrinsic when the person derives satisfaction from an external source.

Eg. : Praise from boss for good performance, a public citation in the same context etc.,

**11.6 Motivation Vs Demotivation :** To motivate the subordinates and know the climate and atmosphere in the campus of the organization, this distinction is highly needed.

When is one said to be motivated?

- \* One comes to work willingly
- \* One gives the best of one's efforts at work
- \* One has sense of belongingness and pride in associating with the organisation job.
- \* One is very much committed to work etc.,

**Demotivation is understood from :**

- \* high rates of absenteeism and personnel turn - over
- \* curtailed output / productivity
- \* increased no. of accidents
- \* high wastages / defectives
- \* heavy loss due to bad handling
- \* rank indiscipline
- \* frustrated work force
- \* defiant and violent behaviour
- \* frequent confrontation and arguments with supervisors etc.,

**11.7 Importance of Motivation in Management :** Any organisation will be dynamic only when its people are dynamic. People are dynamic when people are competent, fully grown, developed etc. Development and growth on the part of people in an organisation do not come from vacuum. Hence, need for motivated people arises and then, motivated people in all the levels of hierarchy are to be there to motivate others further since it is only qualitative task force or motivated work force that is required to build an organisation and achieve organisational goals. Hence, manager should explore the ways and means of motivating subordinates.

**11.8. How to Motivate?**

- \* By recognising the individual differences
- \* By matching the Jobs with the people (or) Vice-Versa.

- \* By using goals and individualising the rewards
- \* By linking rewards to performance
- \* By formulating good personnel policies
- \* By adopting decentralisation and delegation of authority wherever it is needed.
- \* By maximising job satisfaction by job enrichment
- \* By following systems like MBO and MBWA
- \* By rewarding frankness and openness
- \* By encouraging creativity of the personnel
- \* By creating good organisational culture, climate and health.
- \* By improving employee morale etc.

**11.9 What does demoralise? :** Sometimes, motivational and morale aspects in an organisations are very poor due to some practices unwarranted. Hence, it will be good, if they are avoided.

- \* **Under assignments** to people capable of doing tough and takes of responsibility and risk.
- \* **Over Assignments** to people beyond the capacity and comettence.
- \* **Buckmastership:** It is a practice where some superiors avoid doing hard works, pass it on to the lower level people and finding fault with them. This practice erodes employee motivation.
- \* Managers must not be manipulative and cohesive in their attitudes.

**11.10 Theories on motivation :** Several following theories have been developed by Psychologists and social scientists.

- \* Skineer's Behaviour Modification theory
- \* McClelland's need for achievement theory
- \* Abraham Maslow's need heirarchy theory
- \* Frederic Herzberg's two factor theory
- \* Adam's Equity theory
- \* Vroom's Expectancy theory
- \* Alderfer's ERG theory etc.

**(i) Maslow's Theory :** This is the most widely known theory on motivation which finds needs of human beings in a form of heirarchy. The basic conclusion of this theory is that a need that is satisfied is not any longer a need to be satisfied further.

**Proposed concept of heirarchy of needs :** The following are the human needs arranged in an ascending order by Abraham Maslow, a Psycologist : (See the figure).

**a) Physiological needs :** These are basic and essential needs like : Food, shelter and clothing. The idea of Maslow is that other level needs do not influence people until these needs are met.



**b) Security needs :** These needs are second level needs in the hierarchy. They are about safety and security to the Job, the Job doer, family for the present and future.

**c) Social needs :** People want to love and be loved, console and be consoled as people are social beings. They want to like and be liked. They don't like to be in isolation and deserted.

**d) Esteem needs :** It is human Psychology that people ask for music and entertainment when hunger is satisfied. People now ask for power, prestige, esteem, recognition, authority, dignity etc.

**e) Self Actualisation needs :** This is the last step of the Maslow's ladder of needs. This set of needs is about one becoming what one is capable of becoming, from the point of view of one's own potential.

#### Criticism :

- \* Maslow's very hierarchy of needs concept, has become a big subject of ridicule.
- \* Several researchers couldn't find supporting evidence to the finding of Maslow.
- \* Some are of the opinion that physiological and safety needs will not be of much importance while social, esteem and self actualisation needs are more important, as managers start growing in an organisation etc.,

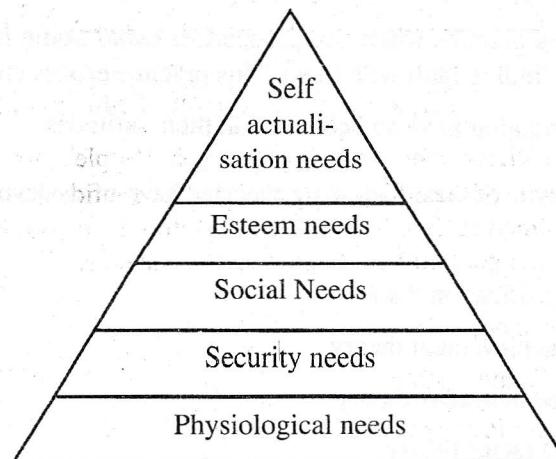

Figure : 11.1 Maslow's Need Hierarchy

**(ii) Frederick Herzberg's Two Factor theory :** This is another needs theory. Herzberg introduces two factors called : Dissatisfiers and Motivators, to explain his theory.

**Meaning of dissatisfiers :** These factors are called dissatisfiers as their qualitative and quantitative existence in any organisation does not yield any satisfaction and yield only "No dissatisfaction". But definitely, their non-existence, does lead to dissatisfaction. Hence, they are called aptly maintenance, hygiene or Job context factors.

Eg. : Supervision, salary, Job security, interpersonal relations etc.

**Meaning of Motivators :** The existence of these factors may lead to satisfaction (or) No satisfaction. These are real motivators as they possess the potential of yielding a sense of satisfaction.

Eg. : Achievement, recognition, challenging work, advancement etc.

**Crux of the Theory :** Though 1st set of factors do not motivate, they must be present as they maintain people, test, there should be dissatisfaction. It is only 2nd set of factors that motivates people in an organisation. The dissatisfiers and motivators of Herzberg resemble Maslow's Need's Heirarchy (See Figure).

**Criticism :**

- \* The research methodology adopted by Herzberg itself aroused a lot of criticism.
- \* Findings of other researchers have not agreed with Herzberg's findings.
- \* Too much focus on "satisfaction (or) dissatisfaction" etc.

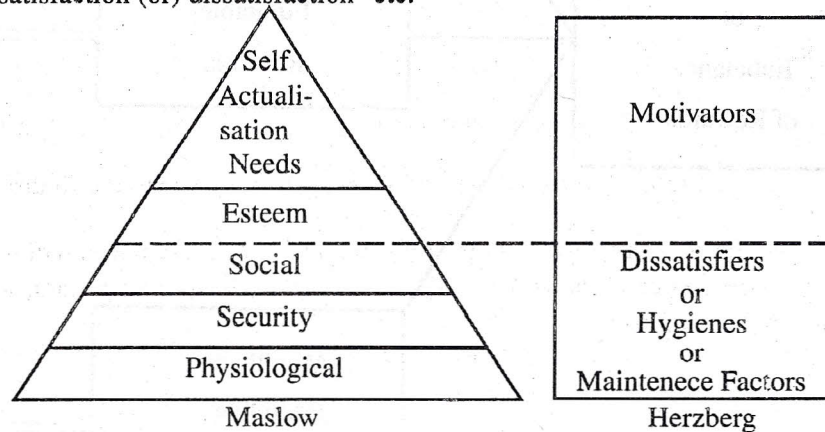

**Fig 11.2** Comparison of Maslow and Herzberg

**(iii) Victor Vroom's Theory :** Victor Vroom is a Psychologist. People's motivation is dependent upon the value that is attached to the outcome of the efforts multiplied by the confidence that they have that their efforts will help them attain their ends aimed at. In other words, motivation is the product of anticipate value of the goal and the probability to attain the goal. In Vroom's terms, it is stated as :  $F = VE$ .

Force (F) = Valence (V) X Expectancy (E)

- \* **Force** is the strength of person's motivation
- \* **Valence** is Strength of a Person's Preference for an outcome
- \* **Expectancy** is the probability that a particular way may lead to a expected outcome.

**Comments :**

- \* It is more realistic
- \* It is simple
- \* It is an agreement with M.B.O. etc.

**(iv) Equity Theory : (J.S. Adam) :** Comparison is a potent source of motivation. People's motivation (or) demotivation depends upon this comparison of their rewards with that of others. On comparison, if people notice that there is balance, there is status-quo, if our rewards are higher, we will be motivated more and thus, we will be demotivated when our rewards are lower relatively. Thus, equity or in - equity in rewards motivates (or) demotivates. (See the figure).



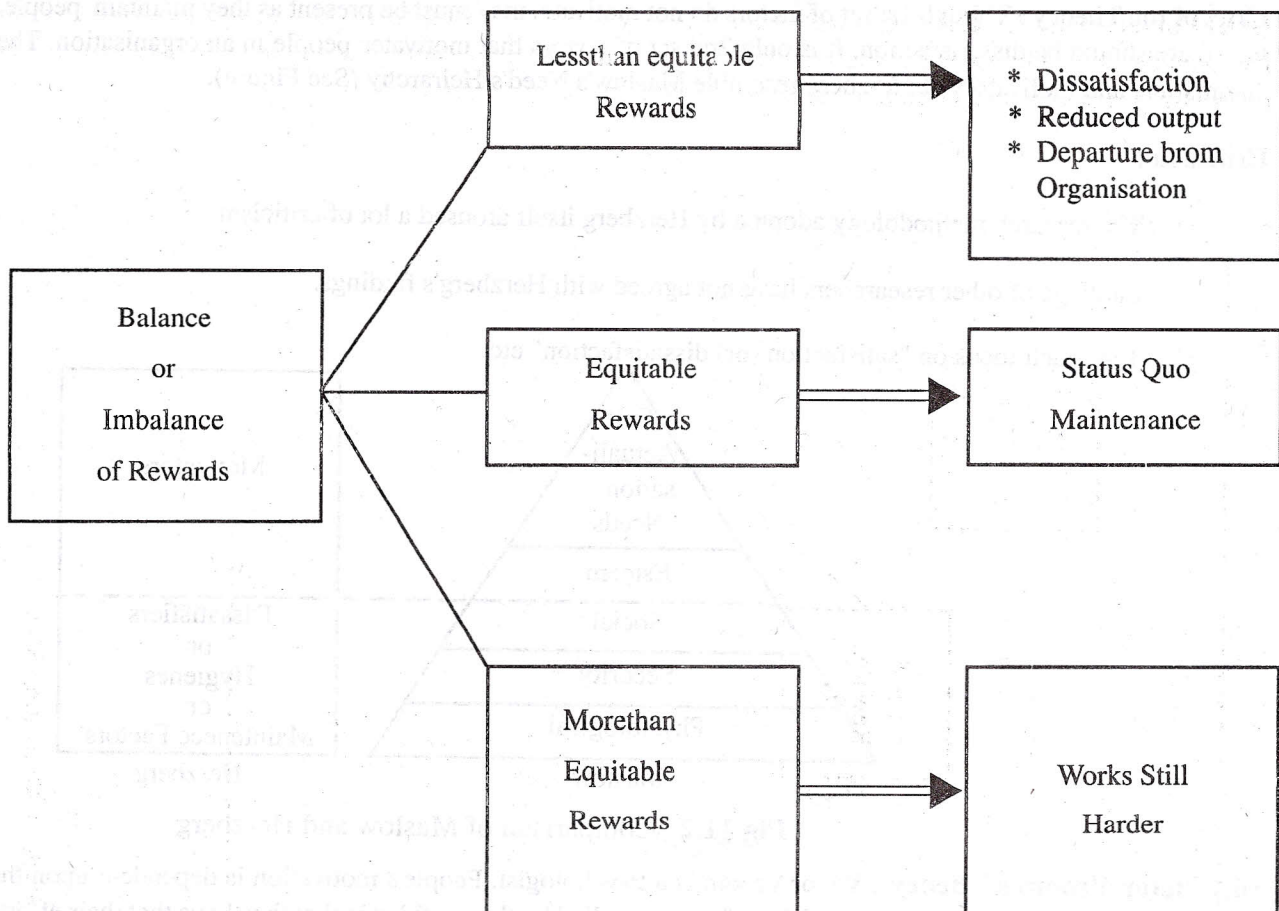

Figure: 11.3 Equity Theory

(v) **B.F. Skinner's Behaviour Modification (or) Reinforcement Theory** : This theory is developed by a Psychologist. This is somewhat related to behavioural aspects of animals originally and then human beings. This is also called "learning" theory, as people in the organisation learn to take to a particular behavioural pattern based on the consequences that followed a particular pattern of behaviour, in the past. When people learn from the past, that certain behavioural patterns were associated with pleasant consequences, the people tend to take to same pattern repeatedly and thus, it is reinforced. In the same way, a bad behavioural pattern can be controlled when people learn that unpleasant things were associated with that pattern in the past. Thus, people may not take to that pattern of behaviour. Thus, behavioural aspects are sought to be modified.

(vi) **E.R.G. Theory of Alderfer** : To a great extent, it resembles Maslow's theory. He is of the idea that all Maslow's needs can be broadly covered under : Existence Needs, Related Needs and Growth Needs.

Existence needs are Maslow's 1st and 2nd level needs, while Related needs are Maslow's 3rd level needs and Growth needs are Maslow's last level needs. The chief point of Clayton Alderfer is that all needs can operate simultaneously.

(vii) **David C Mc Clelland's Needs Theory** : This is another needs theory. Mc Clelland classified all human needs into three categories viz., need for power (n/PWR.), need for affiliation (n/AFF.) and need for achievement (n/ACH). His philosophy is that all these needs are of herculean importance to make the organised enterprise work well while saying that the need for achievement (n/ACH) is of paramount significance.

(viii) **Porter - Lawler Expectancy Model** : A slightly more comprehensive expectancy motivation model has been developed by Lyman Porter and Edward Lawler. This model shown in Figure 11.4 incorporates the relationships between perception, effort, reward, and satisfaction (motivation).

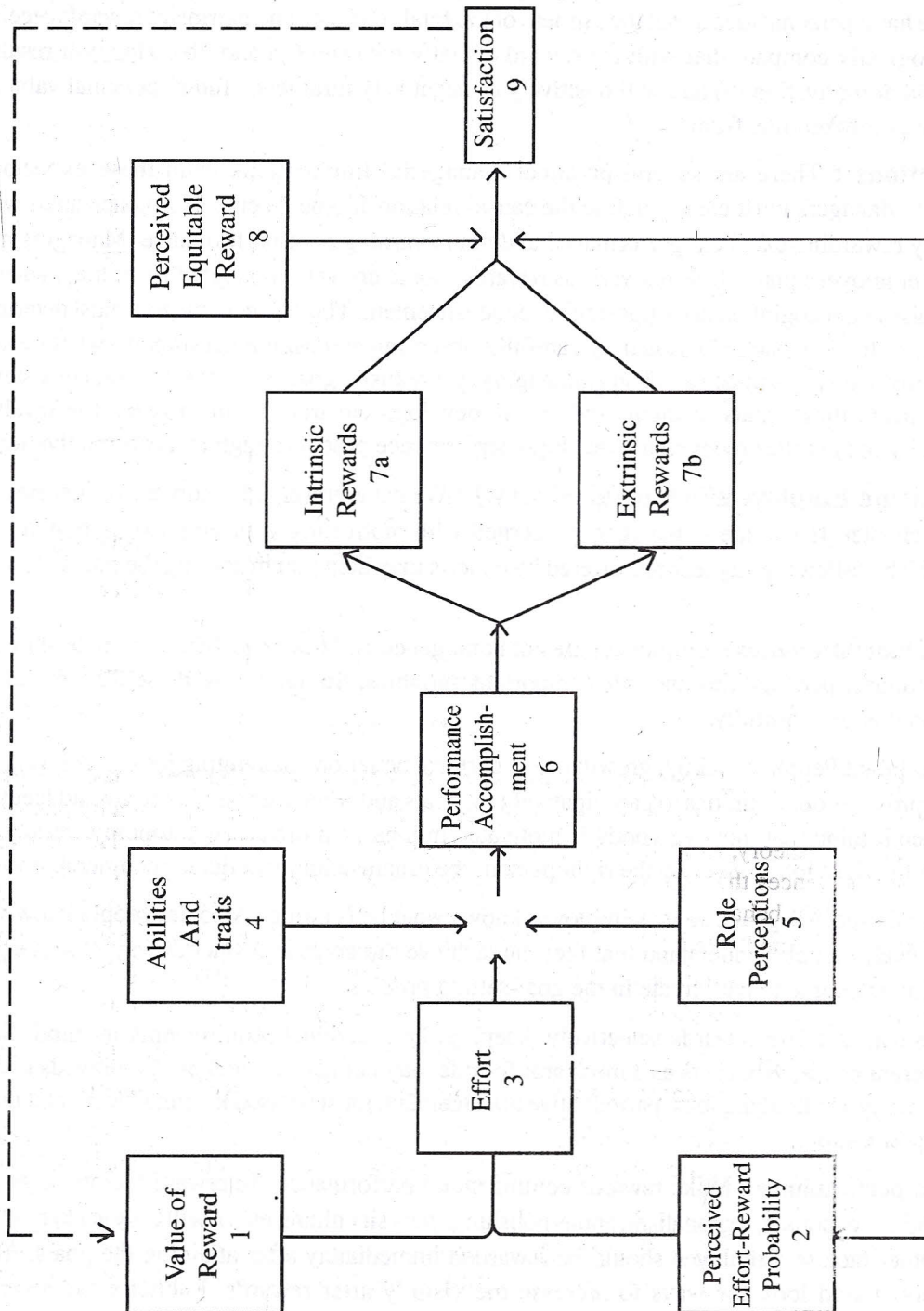

Figure : 11.4  
Porter - Lawler Expectancy Motivation Model



We see from the model that an employee's individual effort (3) is dependent on the value of the expected reward (1) and the perception of the effort involved in performing and obtaining the reward (2) performance (6) then becomes a result of effort (3) a person's abilities and traits (4), and an accurate role perception - how clearly she or he understands the job (5). The performance level produces either intrinsic rewards such as self-esteem or a sense of achievement (7), or extrinsic rewards such as pay increase, promotion, or praise from the manager (7b). Every employee has a personal idea about the fairness of the total (intrinsic and extrinsic) rewards received (8) and will psychologically compare that with the reward actually received (7a and 7b). This will result in employee's satisfaction or motivation (9) and will positively or negatively influence future personal values of certain types of rewards (broken line from 9 to 1).

**Practical Implications :** There are several practical managerial implications from these expectancy motivational theories. Managers must clearly define the causal relationship between performance and reward and discrimination by rewarding excellent performance and not rewarding poor performance. Managers must realize that different employees place different various rewards. Some are very motivated by money, whereas others really want praise and recognition and opportunity for advancement. Therefore, managers must determine the particular rewards valued by each individual by carefully observing and asking her directly what rewards she values most. Finally, managers must establish challenging, yet realistic goals with employees, consistently and clearly, communicate these goals to them, and coach, develop, and train them to reach the levels of performance desired by both parties recognising that high performance produces high levels of motivation.

**11.11 How to motivate Employees? (A detailed view) :** We have presented a number of theories and explanations in this chapter. If you are a manager, concerned with motivating your employees, how do you apply these theories? The following suggestions offered by experts may help you in solving the puzzle to some extent :

(i) **Recognise individual differences :** Employees are not homogeneous. They have different needs, they also differ in terms of attitudes, personalities and other important variables. So, recognise these differences and handle the motivational issues carefully.

(ii) **Match people to jobs :** People with high growth needs perform better on challenging jobs. Achievers will do best when the job provides opportunities to participatively set goals and when there is autonomy and feedback at the same time, keep it mind that, not everybody is motivated in jobs with increased autonomy, variety and responsibility. When the right job is given to the right person, the organisation benefits in innumerable ways.

(iii) **Use goals :** Provide specific goals, so that employee knows what he is doing. Also, let people know what you expect of them. Make people understand that they can achieve the goals in a smooth way. If you expect resistance to goals, invite people to participate in the goal-setting process.

(iv) **Individualise rewards :** Use rewards selectively, keeping the individual requirements in mind. Some employees have different needs, What acts as a motivator for one may not act for another. So, rewards such as pay, promotion, autonomy, challenging jobs, participative management, must be used keeping the mental make-up of the employee in question.

(v) **Link rewards to performance :** Make rewards contingent on performance. To reward factors other than performance (favouritism, nepotism, regionalism, apple-polishing, yes - sir culture, etc.), will only act to reinforce (strengthen) those other factors. Employee should be rewarded immediately after attaining the goals. At the same time, managers should look for ways to increase the visibility after rewards. Publicise the award of performance bonus, lumpsum payments for showing excellence, discussing reward structure with people openly - these will go a long way, in increasing the awareness of people regarding the reward-performance linkage.



(vi) **Check the system for equity** : The inputs for each job in the form of experience, abilities, effort, special skill, must be weighed carefully before arriving at the compensation package for employees. Employees must see equity between rewards obtained from the organisation and the efforts put in by them.

(vii) **Don't ignore money** : Money is a major reason why most people work. Money is not only a means of satisfying the economic needs but also a measure of one's power, prestige, independence, happiness and so on. Money can buy many things. It can satisfy biological needs (food, shelter, sex, recreation, etc.) as well as security, social and esteem needs.

**11.12. Non-Financial Incentives** : Incentives which cannot be offered in terms of money are known as non-Monetary / non-financial incentives. Often money alone is not sufficient to satisfy higher order needs, such as status, recognition, realisation of one's potential, etc. People working at higher level do not always work for money. They expect a challenging job, interesting work that grants them enough power to control environments, work that allows them to use their talents fully. Over the years, organisations have developed a variety of incentives to meet the higher order needs of people working in organisations.

### **Non Financial Incentives :**

#### **(A) Individual Incentives**

(i) **Status** : It is the ranking of positions, rights and duties in the organisation. Research indicated the fact that middle and higher level employees prefer escalations in status increments in pay.

(ii) **Promotion** : It is the vertical movement of a person in the organisation. Promotions are accompanied by increased responsibilities, enhanced prestige and power, usually. Since promotions depend on good performance, most employees try to attain these if the organisation provides the opportunities.

(iii) **Responsibility** : People want to handle responsible and challenging jobs. If the job is responsible, it satisfies people in more than one way.

(iv) **Recognition of work** : Managers can motivate people by using this in the ways. Show appreciation when an individual does an outstanding job; compliment individuals in front of others; compliment individuals when the incident is still fresh in their mind. Recognition and appreciation will have a 'tonic' effect on the psychology of employees.

(v) **Interesting work** : Jobs that are varied, pleasant and enjoyable motivate people thoroughly. Such jobs allow people to satisfy their natural instincts. Work in such cases becomes as natural as play or recreation and stimulates people to reach greater heights.

(vi) **Job Security** : People want secure jobs. They want to be assured about their future income and job continuity. For the same reason, people prefer government jobs to private jobs, where the security is good but not the income.

#### **(B) Group Incentives :**

(i) **Social Importance of Work** : People want jobs of high social status. They are prepared to accept such jobs, even when the pay is comparatively less. High status jobs enhance the social status of an individual in the society. Eg., preferring to work in a foreign bank rather than in a good private financial institution.

(ii) **Team Spirit** : People prefer to work in well-knit groups. Those organisations that encourage their employees to do the jobs in a cooperative manner, attract people automatically. When team spirit is encouraged among employees, they will put in their maximum in the service of the organisation.



(iii) **Healthy Competition** : Promoting healthy competition among employees through carefully chosen reward schemes spurs people to work harder.

**(C) Organisational Incentives :**

(i) **Participation** : People prefer organisations that offer them good opportunities to participate in the decision making process. Participation enables people to offer valuable suggestions and concrete ideas and see that these are actually translated into action.

(ii) **Sound Human Relations** : A positive work climate where people are treated as human beings is an important reward. It permits people to work with enthusiasm and spirit and contribute their best.

(iii) **Morale** : Morale refers to the atmosphere created by the attitude of the members of an organisation. Poor morale is an organisational malady. The warning signals to be noted here are in the form of absenteeism, tardiness, high turnover, strikes and sabotage, lack of pride in work, etc.

(iv) **Communication and Discipline** : Proper communication and good disciplinary procedures enables people to work with confidence and along the prescribed routes. The behaviour is consistent with goals and the changes of meeting the goals are high.

Since motivation is very much related to another important concept in management-Morale, and since morale and productivity are also very much related with each other, an attempt is made to discuss morale in the next section.

**11.13. Morale and Productivity** : Morale is a word with multiple meanings. Mayo defined it as 'the maintenance of cooperative living'. In this sense, it refers to a sense of belonging to a group. Dr. Loughton described morale as the "capacity of a group of people to pull together persistently and consistently in pursuit of a common purpose". Thus, acceptance of a goal and commitment on the part of the group to work for it are important components of high morale, according to this view. Yet, another view expressed by Prof. Kossen links morale with employee attitudes. It refers to 'employees' attitude toward either their employing organisations in general or toward specific job factors, such as supervision, fellow employees and financial incentives. Researchers, to add to the confusion, generally come out with two formulations while using the term morale (i) job satisfaction as the concern of an individual and (ii) morale as a group phenomenon. Writers like Halloran, to clear the fog, used the term morale in two different ways.

(i) **Individual Morale** : Individual morale involves knowing one's own expectations and living up to them. If we recognise our needs and know how to satisfy them; our morale will be high. Here, morale refers to the feelings of an employee toward his work; it is a matter of work satisfaction.

(ii) **Group Morale** : Where as individual morale is one person's attitude toward life, group morale reflects the general tone, or, esprit de-crops, of a group of people. Each person either heightens the prospect of the team spirit or lowers the concept of a cooperative effort. Morale, used in this sense, emphasises social reactions and concentrates on attitudes towards group values (cohesiveness, interest, common thinking, etc.). According to McFarland, morale is a concept that describes the level of favourable or unfavourable attitudes of employees collectively to all aspects of their work-the job, the company, their tasks, working conditions, fellow workers, supervisors and so on. Guion listed five factors as source of satisfaction contributing to good morale. To say my morale is high in a way means "I feel good."



### Factors Affecting Morale

Human behaviour is difficult to explain. A clerk working under an authoritarian boss might be quite happy with himself, the boss and the organisation. Yet, an officer with a five-figure salary can experience morale problems. What affect the status of morale? Let's explain these factors in greater detail :

**(i) Organisation :** The goals of the organisation influence the attitudes of employees greatly. If the goals set by management are worthwhile, useful and acceptable, then workers develop a positive feeling toward the job and the organisation. Likewise, a clear structure with well-defined duties and responsibilities encourages people to work with confidence. The reputation of the company is another important factor worth mentioning here. Persons working in reputed organisations experience feelings of pride and a spirit of loyalty.

**(ii) Leadership :** The actions of managers exert a strong influence over the morale of the workforce. Fair treatment, equitable rewards and recognition for good work affect morale greatly. Workers feel comfortable when they work under a sympathetic, caring leader in place of one who is authoritarian, dictatorial and dominating. Negativism, inconsiderateness and apathy are not conducive to development of a good work climate.

**(iii) Co-workers :** Poor attitudes of co-workers influence others. Imagine working with a person who talks about the negative points of an organisation all day long. Such a person can make each workday an unpleasant experience for others. He can cause co-workers to think negatively, and even if they don't, such an attitude is certainly not a morale booster.

**(iv) Nature of work :** Dull, monotonous, repetitive work affects employee morale adversely. On the other hand, if an employee is asked to do something interesting and challenging, his morale may be high.

**(v) Work environment :** Morale is a direct function of the conditions in the workplace. Clean, safe, comfortable and pleasant work conditions are morale boosters.

**(vi) Employee :** How the employee looks at himself (the self-concept) also influences morale greatly. For example, individuals who lack self-confidence or who suffer from poor physical or mental health frequently develop morale problems. Further, how the employees personal needs are satisfied can significantly influence their morale. Salary, fringe benefits, DA rates, allowances may affect employee morale in a positive or negative manner, when they compare themselves with others doing similar jobs. Employees can become disgruntled when they feel that their pay and benefits are not in line with the current industry rates or are not keeping up with rising prices.

**Morale and Productivity Relationship :** Generally, it is believed that high morale will lead to high productivity. However, Pof. Keith Davis points out that there is not always a positive correlation between the two. A manager can push for high productivity by using scientific management, time studies and close supervision. High production and low morale may result, but it is doubtful whether this combination can last. The opposite can also occur-there can be low production with high morale. In this case, the manager works so hard to please his subordinates that they are to happy to work hard for themselves. Relationships between morale and productivity are shown through figure 11.5.

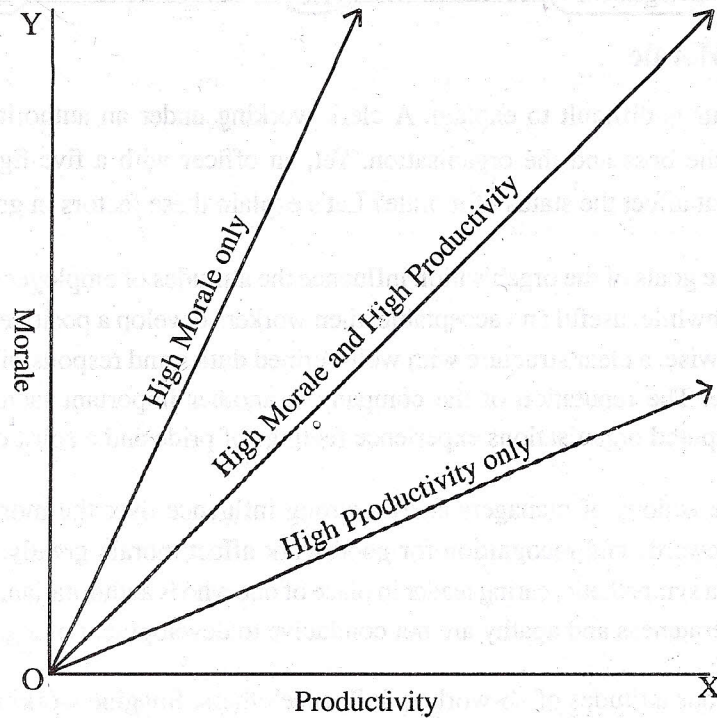

Figure : 11.5 Morale and Productivity

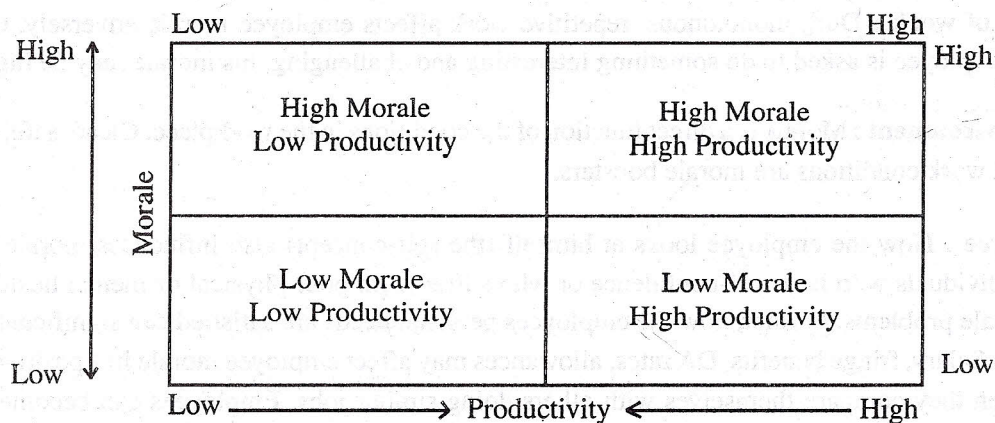

Figure : 11.6 Morale and Productivity

**Morale and Productivity Relationship :** Research carried out by Rensis Likert indicated the fact that there can be different combinations of morale and productivity: high morale and low productivity, high morale and high productivity, low morale and high productivity and low productivity and low morale. See figure 11.6.

In the final analysis, a manager has to work for improving the morale of his employees. High morale makes the work more pleasant and will go a long way in improving the work climate. It helps the work group to attain goals easily, smoothly and more importantly, in a highly cooperative manner. But the important point here is : how to raise employee morale? What about the role of management in building morale in the organisation?



**Morale Development :** Maintaining a reasonable level of morale is not an easy job. Some of the important steps that need to be taken up by management, that too, on a continuous scale, are listed below :

(i) **Remuneration :** The remuneration must be fair and equitable. It should be fair in relation to employees skills and abilities and equitable in relation to the wages prevailing in the industry.

(ii) **Job security :** The employee must be sure of his job and its continuity.

(iii) **Participation :** Employees must be treated as 'resources'; not as tools'. They must be allowed to participate in all important decisions affecting their lives in the organisation. Participation makes employees more committed to their job and allows them to exchange their ideas, suggestions with others.

(iv) **Job enrichment :** Enrichment is a process of making jobs more responsible, challenging and interesting. Enriched jobs offer employees opportunities for achievement, recognition and growth.

(v) **Organisation structure :** Tall structures increase the distance between the manager and his employees. Often, Communication gets distorted and control becomes difficult. Flat structures permit the employee to move closer to the manager and discuss the implications of commands on a face-to-face basis. A healthy interchange of ideas can take place often, paving the way for a positive work climate.

(vi) **Grievance redressal :** Many a time, grievances are the cause of low employee morale. The use of a well-established procedure helps in redressing employee grievances promptly. The case of the employee is presented to the appropriate authority in time, putting an end to unpleasant arguments, and conflicts.

(vii) **Employee counsellors :** Companies can have the services of behavioural scientists in order to tackle important causes of poor employee morale, i.e., absenteeism, tardiness, turnover, etc. The counsellor's basic function is to assist employees with their problems and complaints, and put them on the right track promptly.

(viii) **Sound leadership :** Top management must be genuinely interested in the employees at all levels.

They must undertake sound human resource practices (prompt grievance redressal, safety measures, discipline rules, welfare activities, equitable compensation schemes) for building good employee relations. They must listen to the problems of employees patiently and sympathetically. They must inspire their subordinates (remember not to frustrate or dampen the spirits) through their actions. Morale surveys, absenteeism and turnover records, observation and listening to all, help in initiating steps promptly. Their attempt, in the final analysis, must be to improve the mental health of employees.

**11.14. Summary :** Of all the functions of Management, motivation is the most important one. The basic point is that an organisation requires people to accomplish organisational goals but the people are motivated people. Motivated people are fully committed to the organisation. To say whether people are motivated (or) not can be understood by verifying whether people are wholeheartedly involving themselves in organisational activities (or) not. When people have sense of belongingness, and their association with the organisation is a source of pride to them, and when they are all happy, they are the most motivated. This is manager's task.



**11.15. Key words :**

1. **Directing** : It is an important managerial function of telling persons about what to do and seeing that they do it to the best of their ability. It is through directing that managers get the work done through people.
2. **Motivation** : Motivation is what managers do to induce the subordinates to act in a desired manner.
3. **Intrinsic and Extrinsic Motivation** : Motivation is intrinsic when it is derived from the very Job that the employee does. Motivation may be extrinsic when the person derives satisfaction from an external source.
4. **Dissatisfiers** : These are the factors called dissatisfiers as their qualitative and quantitative existence in any organisation does not yield any satisfaction and yield only "No dissatisfaction".
5. **Motivators** : Motivators are those that possess the potential of yielding a sense of satisfaction.
6. **Force** : It is the strength of persons motivation.
7. **Valence** : It is the strength of persons references for an outcome.
8. **Expectancy** : It is the probability that a particular way may lead to a expected outcome.
9. **Morale** : It is capacity of a group people to pull together persistently and consistently in pursuit of a common purpose.

**11.16. Self Assessment Questions :**

1. Why is motivation important in any organisation?
2. How can you motivate you people? list the do's and dont's that you may come to know of ?
3. Explain theories of motivation ?
4. Explain what are non-financial incentives to motivate?
5. What is morale? How do you improve this?

**11.17. Further Readings**

- \* Harold Knootz, Management
- \* Robin S.P., Organisational Behaviour
- \* Fred Luthans, Organisational Behaviour
- \* VSP Rao and Hari Krishna, Management
- \* L.M. Prasad, Management Principles and Practice

**Dr. G. Satyannarayana**

# COMMUNICATION

**Objectives :** This lesson seeks to help you learn :

- the concept of communication,
- process of communication,
- barriers in communication,
- effective communication,
- informal communication,
- communication in India.

**Structure :**

- 12.1 Introduction
- 12.2 Importance
- 12.3 Process of Communication
- 12.4 Barriers
- 12.5 Effective Communication
- 12.6 Communication Media
- 12.7 Communication Flow
- 12.8 Communication in India Organisations
- 12.9 Summary
- 12.10 Key words
- 12.11 Self Assessment questions
- 12.12 Further Readings

## **12.1. Introduction :**

It is transfer of some information, understanding, ideas, emotions, etc., from one person to another person and again from that another person to that one person who is first to inform. It involves some exchange of facts, ideas, opinions, emotions by two or more people. The purpose that communication seeks to achieve is to motivate (or) influence the behaviour. It is very much important in management as management is getting things done by (or) through others. How do others do anything while they are not informed of what they have to do? Practically, management is a big zero in the absence of communication.

- \* **It is bilateral :** Definitely, should there be any fruitful communication, there must be a minimum of two individuals, since one person can't communicate to one self.
- \* **Step by step :** There are several steps that communication in management shall have to follow. They are : sender, encoding, message, channel, reception, decoding, feedback, (explained in next section).



**Not adhoc :** Communication as an important aspect in Management is a perinial one. There is no any terminal point at which Communication stops. It is continnous as, at every inch, there is some need or the other, for communication.

**Completeness :** Communication is said to be compete (or) effective, when receiver understands the communication in the expected way by the sender of communication and when, this fact is brought to the notice of the sender.

**12.2. Importance :** Communication is all pervasive and every manager and non-manager requires communication in an organisatinal setting. It is not mangnfication if it is said that management is effective only when communication is effective. organisational members do not realise their obligations unless there are some people committed to motivate, lead and convince that there is a need to join hands and work together for the achievement of organisational goals. To perform all these functions successfully, one needs to communicate several things. The undermentioned things establish the importance of communication.

**(i) No Activity at all :** Management is getting things done by others for acheiving orgnisational goals. It implies that several things have to take place in the organisation. The basis and starting point for all these activities is communication. So, no work takes place, in the absence of communication.

**(ii) Successful planning :** The most important aspect in planning is setting objectives, mission, purposes, goals ends, policies, strategies etc., on the one hand and then identifying the means to achieve these goals. It is all decision making process. This decision making will produce the best possible results when all concerned people at different levels of the heirarchy are involved and allowed to participate. People's involvement and participation in decission making are possibly there only when people are good at convincing and counselling the others about all these desired systems.

**(iii) Means of Co-ordination :** Unless all people, departments, divisions, sections etc., in the organizations are co-ordinated, goal achevement becomes difficult. It is everybody's knoledge that managing an organization is not one man's show. It is collective and joint. Communication here acts as a medium to serve this purpose best. In the absence of both vertical and horizontal communication, there can't be management at all.

**(iv) Improves morale, motivation, involvement etc., :** When systems like : free, frank and open communication, participative management, M.B.O., ombudsperson, whistle blowers etc., are there, morale and motivational levels of personnel improve. The implication is that these systems do not improve unless communication is good and effective. Thus, much is done by communication, to the 'orga' and organisational members.

**12.3. Process of communication : (Steps) :** In organisational settings, Communication is a step by step process.

**1st Step : (Sender) :** This starts with sender. On the part of the sender, there must be some idea, information, instruction, etc., to be transformed to the other person called reciever of the communication.

**2nd Step (Encoding) :** Encoding is the process of using verbal (or) nonverbal symbols for sending the message. Words, gestures, symbols etc. may be used by the managers.

**3rd Step (Message) :** This is in fact the information that sender intends to pass on to receiver.

**4th Step (Channel) :** This is the vehicle that carries the message to the receiver from the sender. It may be face to face, a report, a letter, radio, T.V., telephone etc.,

Eg. : Sender can communicate anything to the receiver, by using telephone, face to face etc.

**5th Step (Receiver) :** He is the targeted person at which, the communication is aimed. He may be a subordinate, outsider, superior etc.,

**6th Step (decoding) :** It is the process of understanding the encoded message by the receiver, as receiver is conversant with the code used by the sender.

**7th Step (feed back) :** It is information to sender of the communication from receiver that he has understood the message as per the required pattern.

**8th Step (Noise) :** It is disturbance (or) clutter due to which both senders and receivers of communication are not able to be benefited by the communication. It is all that a communication gap is caused due to this noise. The following figure describes the steps best.

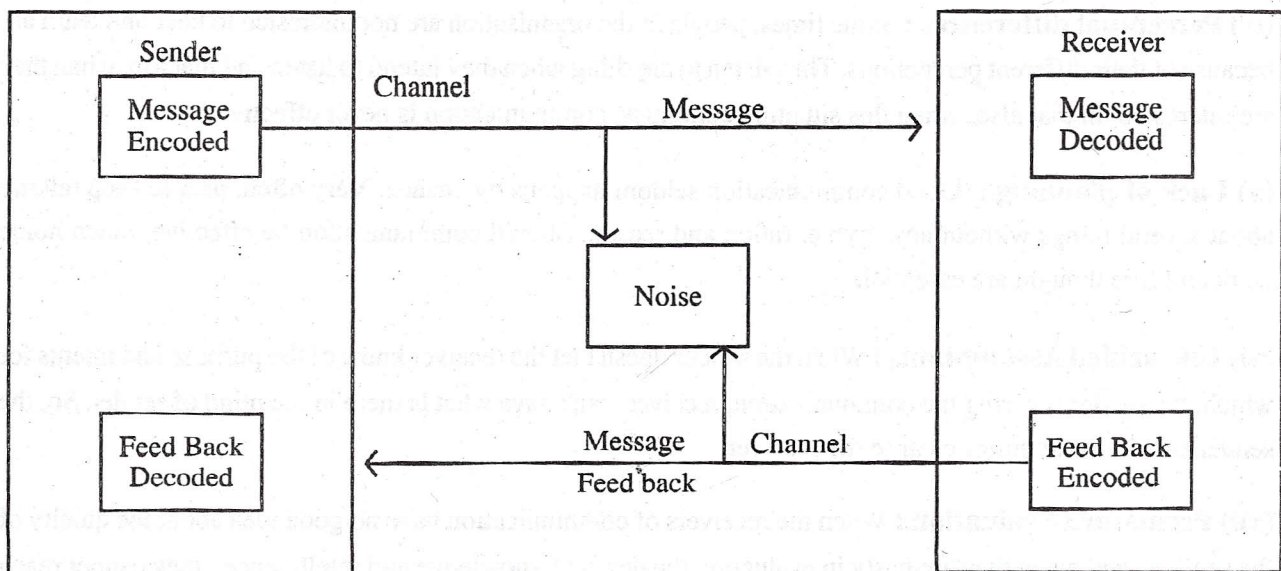

Figure 12.1 : Communication Process



**12.4. Barriers of Communication :** These are several disturbances that come in the way of effective communication. These can be classified into : Semantic - Inter personal - Structural etc.,

**12.4.1. Semantic Barriers :** These barriers relate to the language that the communicator uses and the degree of confusion and complexity in understanding this language. It is a normal point of commonsense that any communication is easily understood if the language is easy to understand and a known language. In language, it is possible that a single word may mean many more things. In that situation, the reciever of the communication may not be able to understand sender's communication. As the knowledge levels of both sender and receiver differ, this communication gap may arise.

**12.4.2. Interpersonal Barriers :**

**(i) No Good Expression :** Sometimes, though communicator wants to communicate something to the other, he is not able to do it effectively. He may not find right words to be used. He may be very brief. He is nervous. Due to any one of these, there may bad expression. He has desire to express. It is for the first time. Thus, a communication gap may be formed.

**(ii) Filtering :** This is a special kind of barrier. It may be on both the sides of communication viz., sender and receiver. Basically it means that these is no complete information low. Only palatable and rosy part of the information is passed on. Thus, total information is denied. Due to this, there is every possibility that communication is used to one's own advantage. There is communication gap.

**(iii) No attention :** People most often do not pay attention to what others say. Definitely, there is loss of information due to this in attention. Telling the other is easier than listening to the other.

**(iv) Perceptual differences :** Some times, people in the organisation are not interested to hear and learn all, because of their different perceptions. They listen to anything when they intend to listen and that too, when they are interested in that also. when this situation continues, communication is never effective.

**(v) Lack of planning :** Good communication seldom happens by chance. Very often, people keep talking about several things without any rhyme, ration and reason. Should communication be effective, much home work and fore thought are essential.

**(vi) Unclarified Assumptions :** When the sender doesn't let the receiver know of the purpose and intents for which, the sender is giving the communication, receiver can't have what is there in the mind of sender. So, the sender should make things clear to the receiver.

**(vii) Premature Evaluation :** When the receivers of communication have no good idea about the quality of the senders, and when they are hasty in evaluating the depth of knowledge and intelligence, they cannot reach the sender's communication. It is due to hasty and pre-poned evaluation. Thus, premature evaluation prevents the receivers of communication from getting complete and more information about anything.



**(viii) Poor retention and loss by transmission :** Definitely, there will be loss of information when there are many more levels or stages by which the communication has to pass through, since, every level or stage acts as a filter. This problem gets further aggravated by the poor retention problem. When we get the message from our top and when we have to pass it as to our lower levels, definitely we don't furnish the lower levels all that we have had. This is retention problem. This multiplies with series of transmission.

**(ix) Impersonal Communication :** Effectiveness of communication is much more in personal communication than in impersonal communication. When face to face communication is not there, there is much scope for communication gap.

**(x) Information over load :** When the receivers of communication are heavily supplied with information, it becomes difficult to identify what is needed and not needed in this big heap of data. In this way, the purpose of communication may not be served best at times.

**(xi) Time pressure :** At the best, the purpose of communication is to bring about a change in the other person. When the normal time required for the situation is allowed, it is right. But, when he is pressurised by the time constraint, the needed change may not be obtained. Thus, the efficacy of communication is partial when the needed environment is not created to obtain the desired behavioural patterns.

**(xii) Distrust, Fear, Threat, Jealousy etc :** When the prevalent organizational climate is full of distrust, illwill, fear threat, jealousy etc, any communication is waste and this does never serve the purpose. There is much communication gap because of higher levels of skepticism. As long as a climate of trust, open and honest communication, is not developed, Communication gaps tend to multiply, leading to ineffectiveness of communication.

#### 12.4.3. Structural (or) Organisational :

**(i) Hierarchy :** When organisational structure increases in size and when many more levels are added, there is every possibility that the information is distorted and delayed due to multiplicity of levels of hierarchy.

**(ii) Status / level :** When there is no open or free communication between superior and subordinates due to their differences in status and levels, there will not be good and effective communication.

#### 12.5. How to make communication Effective?

- \* The purposes of communication must be made clear.
- \* Accordingly, a plan is to be defined to achieve the end.
- \* This planning must not be done in vacuum. All concerned people must be associated with it.
- \* Communication is always, effective when it is in response to the needs of the other people.

- \* At the time of coding, encoding and decoding stages in communication, words and symbols known to the senders and receivers must be used.
- \* Communication will be effective when both the parties to the communication do play their roles effectively.
- \* Communication is effective and complete only when it is ensured that the sender of the communication gets feed back that it has been rightly understood.
- \* To make the communication more effective, the senders (especially superiors) have to be more empathetic towards the receivers (especially subordinates) of the said communication.
- \* Communication, to be effective, requires both the parties to the communication, to be good and effective listeners also, as good listening is considered to be the best key for effective communication.
- \* Communication can be effective when our non-verbal communication also is in support of verbal communication. Hence, it is very much impertive to see that the body language also is favourable to the formal verbal communication, when there is no any bad intention behind.

**12.5.1. Making Communication Effective (A detailed View) :** Communication is the lifeblood of an organisation, and without it, the organisation cannot exist. Therefore, managers must ensure that there is adequate and smooth flow of communication in all directions. For this purpose, management has to take action on two aspects: measuring the effectiveness of the present system of communication, and taking necessary steps for making communication effective, if the present one is not effective.

**12.5.2. Measuring Effectiveness of Communication :** There should be a periodic measurement of effectiveness of communication. However, Communication is one of the most difficult of all the managerial activities to measure. Quantitative and objective proof of the success of effectiveness is inordinately hard to come by. However, in evaluating communication, much can be accomplished by a systematic approach utilising a planned method of evaluation that looks for result in terms of stated objectives and take into account both success and failure. Any assessment of communication, as such, requires the determination of the criteria for this evaluation and fixation of norms in respect of these criteria. Both of these are, further, to be oriented to the basis objective of the process itself. In general terms the objective of communication may be defined as the passing of ideas and understanding from the sender to the target with a view to getting the desired behavioural response from the latter. The finding out of the actual behavioural responses and comparing these with the expected ones, however, in case of this continuously ongoing process, presents insurmountable difficulties. The ultimate objectives of the communication are related to the communication programmes through their relationships with immediate objectives. Effective Communication, as such, might be the accurate transmission and receipt thereof and its correct understanding. There are several elements in communication which can be evaluated to assess directly the effectiveness of communication. These elements are clarity, adequacy, timing and integrity of communication.



(i) **Clarity** : The communication process, in order to serve its purpose, must ensure clarity of communication, thereby facilitation exchange of clarifications. A communication process clarity is complete when it is expressed in a language and transmitted in way that will be comprehended by the receiver. The basic objective of communication is to bring two minds together, and this is possible only when what the sender means is understood by the receiver in the same way.

(ii) **Adequacy** : There are, broadly speaking, two aspects of adequacy, viz.: (i) in terms of coverage, that is, types of messages flowing in various direction; and (ii) in terms of quantity of various types of messages. The problem of determining adequacy in regard to coverage is not very difficult. Through communication audit, the adequacy of coverage, the information need of various groups of managers and employees and compares it with what has been made available to them. Normatively speaking, the process of communication must ensure that all those messages that are needed by the various individuals in the organisation in connection with the effective discharge of their official duties must flow up to them and further that this flow in respect of different types of messages must be adequate.

(iii) **Timing** : The utility of any message to the receiver is markedly affected by its timeliness. The process of communication should, therefore, not only ensure that the message reaches the receiver but also that it reaches him when he requires. It is quite possible that a person may require some time to compile an information having diversified and complex contents, which he has to collect from several points in the organisation. A suitable time span should be allowed for the purpose of considering urgency and time requirement of the information.

(iv) **Integrity** : The principle of integrity of communication suggests that the purpose of communication is to support understanding by the individuals in their achieving and maintaining the co-operation needed to meet organisational goals. Effective communication is not an end in itself, rather, it is means to get some ends. Though the immediate objective of any communication is to get behavioural response from the receiver of the communication, its ultimate objective goes beyond that. The ultimate objective of communication may be to get change in behavioural response from the receiver. This may suggest that communication to be effective should be persuasive and convincing so that receiver acts accordingly.

Besides, communication can be evaluated in terms of behavioural ultimate objective where it can be measured in terms of behavioural response. Such responses may be reflected in the form of attitude and morale, employee relations, and other factors. The analysis of these factors, in general, will provide total picture of effectiveness of communication. The higher degree of these factors may be due to a variety of variables, communication plays an important part in this respect. Thus, analysis may lead us to conclude about the effectiveness of communication as a whole.

In the perspective of the above discussion, we may conclude that the communication is effective if:

adequate communication flows to different points in the organisation.



- (ii) the message received is very close to the message sent :
- (iii) the non-verbal message is congruent with the verbal message;
- (iv) the message elicits the desired response; and
- (v) the communication results in building trusting relationship between the source and the target.

**12.5.3. Steps for Making Communication Effective :** When the communication is evaluated in the light of the criteria discussed above and inadequacy is if found, management must take appropriate actions to make communication effective. While actions may be specific in the light of the inadequacy, here, some general guidelines have been provided for effective communication.

**(i) Clarity in Idea :** The communication should be quite clear about what he wants to communicate. Communication is a process starting with ideation which includes generation of ideas which are meant for communication. This is the subject - matter of communication and may include opinion, attitudes, feelings, views, suggestions, orders, etc.

**(ii) Purpose of communication :** Every communication has some purpose, the basic purpose of any communication being to get behavioural response from the receiver of the communication. However, the ultimate objective may be extended further, for example, getting an order accepted by the subordinate. The communication should be directed towards this objective by the efforts of communicator.

**(iii) Empathy in Communication :** The way for effective communication is to be sensitive towards receiver's needs, feelings, and perceptions. This is what psychologists call empathy in communication, implying putting legs in other's shoes, or projecting oneself into the viewpoint of the other person. When the sender of the message looks at the problems from receiver point of view, much of the misunderstanding is avoided.

**(iv) Two-way communication :** Communication is a two-way traffic and this fact must be realised in communication. Two way communication brings two minds together which is the basic core of any communication. It involves a continuous dialogue between sender and receiver of the message. Upward communication can become a reality in the organisation and effective if this fact is recognised.

**(v) Appropriate Language :** The subject-matter of communication is transmitted by decoding it into some symbols. such symbols may be in the form of words, either spoken or written, and gestures. If the words are used, the language used for communication should be such which is understandable by the receiver. Technical terminology and multisyllable words may be impressive looking, but they can also be troublesome to the listener. One way of making the communication simple is to use repetitive language with which the receiver is quite familiar.

**(vi) Supporting Words with Action :** Often it is said that action speaks louder than words. While communicating, the sender may use the actions to emphasise a point. This enhances the understanding as well as emphasises the important point in communication. Further, the sender of the message must also follow in action what he says to others. This will ensure the seriousness in communications.

(vii) **Credibility in Communication** : One criterion for effective managerial communication is that it has credibility or believability. The subordinates obey the order of the superior because he has demonstrated through his competence that he is worthy of trust. He must also maintain his trust and credibility. Thus, any communication which is based on this trust and credibility will be followed by the subordinates.

(viii) **Good listening** : A communicator must be a good listener too. By this process, he is not only giving chance to others to speak but he gathers useful information for further communication. By concentrating on the speaker's explicit and implicit meanings, the manager can obtain a much better understanding of what is being said. Managers suffer from some common habits of bad listening, though much of their communication time is spent in listening. Newstrom and Davis have suggested ten points which may be observed in listening. These are : stop talking, put the talker at ease, show the talker that you want to listen to, remove distractions, empathise with the talker, be patient, hold your temper, go easy on arguments and criticism, ask questions, stop talking. They have emphasised stop talking because without stopping "talking", one cannot listen to.

## 12.6. Communication media (or) Methods

Broadly, the media in communication consists of

- Oral (or) verbal communication
- Written communication and
- Non - verbal Communication

**12.6.1 ORAL Communication / Verbal Communication** : A great deal of Communication is given often in any organization orally only. Possibly, it may be in a face to face contact of two people (or) in a superior's presentation of some information before a larger gathering or group discussion, a telephone conversation etc. It can be in a formal and informal way. Similarly, it can be a predetermined one (or) an accidental one.

### Advantages :

- \* Easy and inexpensive
- \* Good clarification
- \* Larger gathering can be covered etc.,

### Disadvantages :

- \* No recorded messages
- \* Lengthy messages can't be sent
- \* May be unduly prolonged in case of tug - of - war etc.,

**12.6.2. Written Communication** : It is Communication reduced to black and white. It is in the form of letters, memos, circulars, reports, books, manuals, magazines etc. It may be formal and informal. But, it is very much formal most often.

### Advantages

- \* Provides for Records, references, legal references etc.
- \* Sufficient time availability to prepare clear and clarified message
- \* Wide reach / Coverage etc.,



**Disadvantages :**

- \* Creates mountains of paper work
- \* No possibility to immediate feed back
- \* costly & time consuming
- \* impersonal and inflexible etc.

**12.6.3. Non-Verbal (or) Body Language :** It is giving Communication in a Peculiar way. The peculiarity is that it is body and various limbs of the body that express the message. What a person says can be contradicted or reinforced by this non-verbal communication. Expected situation is that non-verbal communication must be normally in support of oral (or) written communication. But, never it happens like that. This is often through facial expressions, body movements, gestures etc.

**Non-verbal communication (NVC) :** It refers to messages sent through human actions and behaviours rather than through words. It is a communication exchange that does not use words or that uses words themselves (That is why the name: gestural communication). It often relies on facial expressions, body movements, gestures, inflection, tone etc.

**a. Facial expressions :** By observing a person's face, we can readily distinguish such emotions as anger, interest, happiness, disgust, contempt, fear, surprise, etc. Facial expressions (e.g. frown shows displeasure; smile reveals friendliness or happiness, raised eyebrows show disbelief or amazement, etc.) may reveal true feeling more reliably than verbal messages.

**b. Eye-contact :** People tend to establish eye contact for longer periods of time, the more they like each other. Eye contact diminishes when we want to hide something or are in situations where there is dislike, tension or fear of deception.

**c. Dress :** Dress is, often, said to reveal the appearance of power to others. For example, a woman wearing a tailored suit with blazer jacket appears more powerful than one wearing a dress with frills.

**d. Posture :** Leaning toward another individual suggests that you are favourably disposed toward his or her messages: leaning backward suggests, the opposite. Opening the arms or legs is an educator indicator of liking or caring. In general, people, establish closed posture (arms folded and legs crossed) when speaking to people they dislike. Standing up straight generally reflects high self-confidence. Stooping or slouching could mean a poor self-image.

**e. Distance :** If you want to convey positive attitudes to another person, get physically close to that person. People located in relatively close proximity are seen as warmer, friendlier, and more understanding than people located farther away.

**f. Gesture :** Positive attitudes are shown by frequent hand movements. At the other extreme, dislike or lack of interest usually produces few gestures.

**g. Handshakes :** Most people literally talk with their hands. To Americans, a firm handshake indicates decisiveness, whereas a limp one conveys a lack of interest. In France, you can shake hands with your right or left hand without being regarded as impolite. In the Arab world, using left hand (called as toilet hand') is strictly prohibite. Generally, high status people feel free while touching low status people (when giving advice, orders, or when persuading). However, managers should touch others only when saying something positive.

**h. Tone of voice :** Anger is, often, perceived when the source speaks loudly, quickly, and with irregular inflection and clipped enunciation. Boredom is, often, indicated by moderate volume, pitch, and rate. Joy is often indicated by loud volume, high pitch, and rate, and upward inflection.

**i. Use of space or proxemics :** Proxemics deals with the way one uses physical space and what that use says about us. People move closer to individuals whom they like and keep more distance from those people whom they dislike. Individuals generally maintain a greater distance from those people whom they dislike. Individuals generally maintain a greater distance from people with high status. High status people generally invade the space of those with lower status freely. (e.g. MD of a company barging into the room of a manager suddenly). The amount and type of space in an office, the office location (say, top floor reserved for the Boss) and the way it is furnished (air conditioning, carpets, glass tables, etc.) can represent authority, status, position and protection.

**j. Use of time or chronometry :** Chronometry is concerned with the use of time in various situations. If we are late for a meeting, we might be regarded as careless, uninvolved or unambitious. However, the lateness of a high-ranking-official might be perceived as evidence of his or her importance. Looking at your watch is usually interpreted as sigh of boredom or restlessness.

Too many managers are uninformed about and unaware of the nonverbal messages they communicate on the job. They fail to appreciate the fact that without saying a word, they might be influencing the responses of subordinates negatively. Although unintentional, these messages may be interpreted as showing disinterest, coolness, aloofness and even disrespect. Such negative perceptions can have a demoralising impact on the motivation of subordinates. On the other hand, if the manager makes a conscious effort to exhibit positive behaviour toward subordinates, their level of motivation will improve. For example, it does not take a great effort to maintain good eye contact, use a pleasant tone of voice, show enthusiasm and greet others with a smile. Such small gestures enable the manager to move closer to the hearts of subordinates and help him secure their cooperation and commitment toward organisational goals. The effort to use appropriate non-verbal cues will also help in improving interpersonal relations greatly.



**12.7. Communication flow in the Enterprise :** Different kinds of information flows are described here under.

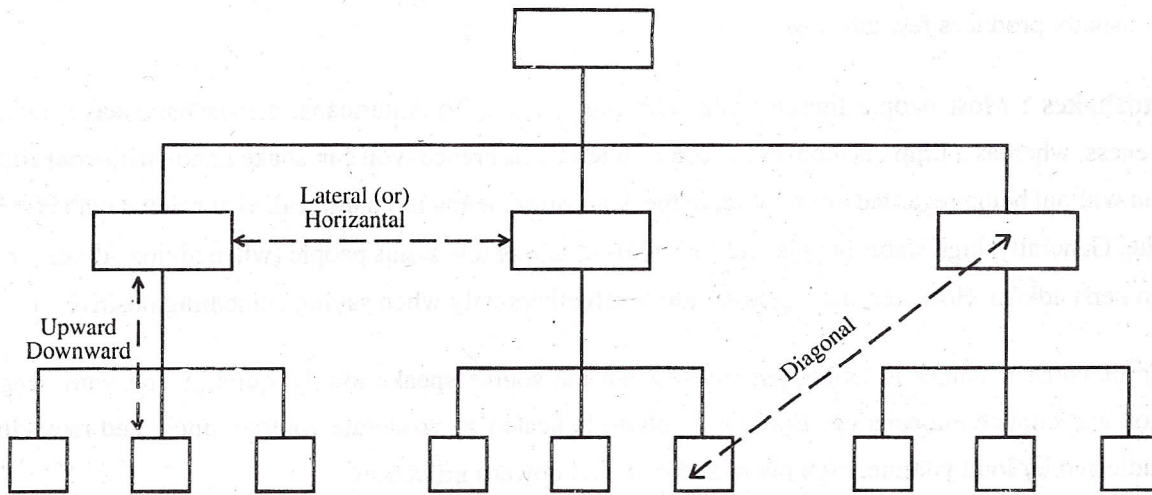

Figure 12.2 : Kinds of information flow

**12.7.1. Downward Communication/Vertical :** This is as per the organisational chart and chain of command and dependent upon the superior and subordinate relations. Management requires the superiors to give communication formally to the subordinates. Communication in this category may include :

- Orders and instructions
- reprimands & Critisims & Comments
- Policies & procedures
- Questions inviting upward communication etc.

**12.7.2. Upward Communication :** It is self explanatory that it is from subordinates to the superiors. It is very much occasional. Examples of this may include :

- \* Suggestions
- \* Requests seeking clarifications
- \* Responding to the questions
- \* Submitting reports / Comments
- \* Explaining procedures
- \* Ombuds person etc.,

**12.7.3. Horizontal / Lateral Communication :** This Communication is between person and people of equal status and level. Some times it may be formal and mostly, it is informal, to promote team work and synergy.

Eg. : Communication about social and cultural aspects

- \* rumours
- \* informal enquiries/ clarification etc.,

**12.7.4. Diagonal Communication :** This is communication between un-equals in different departments and sections in the same organisation for informal purposes only. This is highly informal in nature.

**12.7.5. Formal Communication :** Normally all organisational communication is a formal communication unless it is exclusively qualified. Downward and upward communications are all formal communications. Formal communication is one that is given by a superior to a subordinate when the organisation chart intends it in that way. It is the most usual communication in any organisation.

**12.7.6. Informal Communication :** It is also a kind of communication which doesn't appear in the formal organisation chart. It is not indicated anywhere. It is to be simply understood from the happenings in the organisation. So, it is communication that doesn't adhere to the rules and principles of the organisational structure. The best known type of informal communication is the "Grapevine" (or) "The Rumour mill". Though it is not very much out of place to say, it is to be said here that the informal communication is present in every organisation where there is formal communication and it is very much linked up to informal organisation in a formal organisation. For details, "Organising" managerial function can be read.

**12.7.7. Who is associated with informal communication?**

People like : receptionists, mail and message carriers, delivery persons, maintenance personnel, material handlers, other office staff, etc. are likely to be heroes and heroines involved in the informal communication.

**12.7.8. Grapevine chains :** Keith Davis has identified four possible grapevine chains. They are : single strand, gossip, probability, and cluster. See the below given figure.

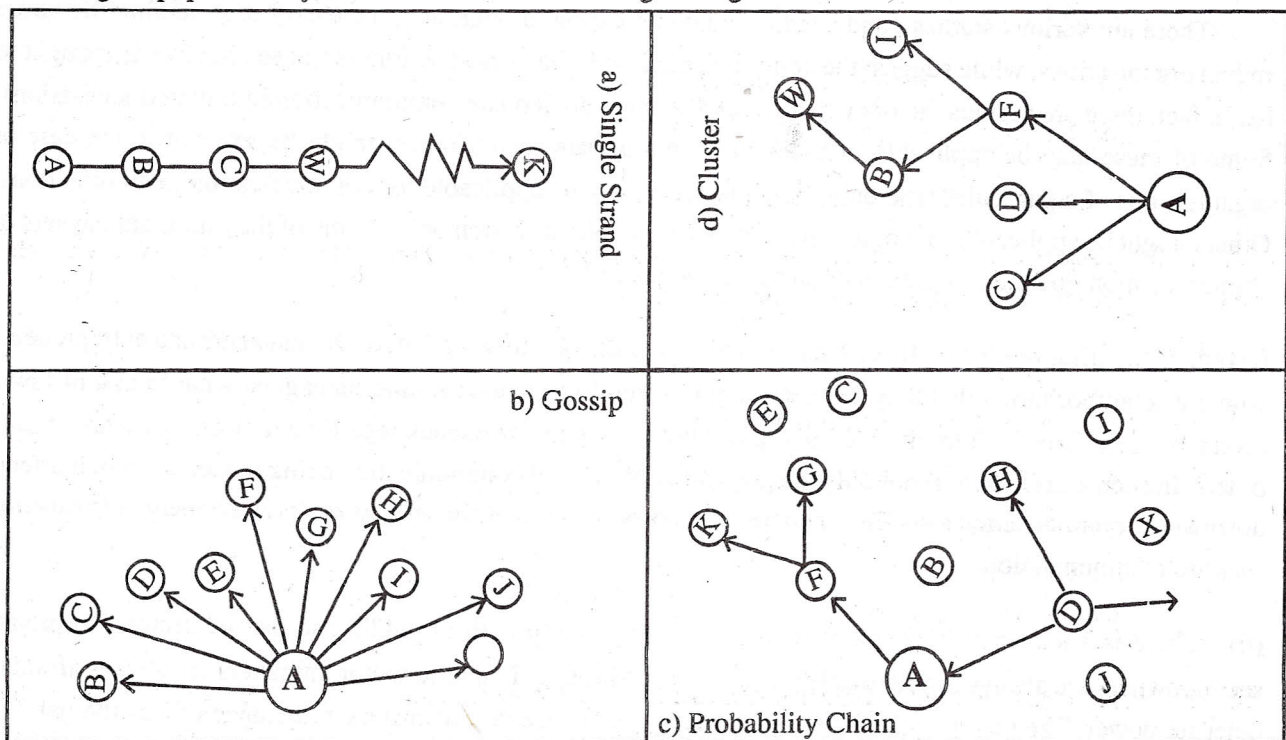

Figure 12.3 : Grapevine Chain



a) **Single Strand Chain** : Person A tells something to person B who tells it to person C and so on down the line. This chain is the least accurate in communication.

b) **Gossip Chain** : One person seeks out and tells the same message to all. When any interesting but non-job related issue is to be conveyed, this chain is attempted.

c) **Probability Chain** : Individuals are indifferent about whom they offer information to. They tell people at random and again those people in return tell others at random. When information is mildly interesting, it is attempted.

d) **Cluster Chain** : A person conveys the message to a few some of whom then informs a few others. Davis is of the opinion that the cluster chain is the most dominant pattern.

**12.8. Communication Pattern in Indian Organisations** : It is generally alleged that communication in Indian organisations is not given proper attention which it so richly deserves. Almost in all organisations in public sector and a great many in private sector Communication is given only secondary importance. While this is the position of communication in general, upward communication, which has to flow against the stream of authority, and more particularly when the managers are generally inadequately and vaguely aware about the need and significance of upward communication, is expected to be even poorer. All communications must be two-way but unfortunately in India, it is mostly one way, and upward communication does not flow properly.

There are various studies conducted on communication, though not adequately representing the entire Indian organisations, while suggest the communication in Indian organisations is not as effective as it ought to be. In fact, there are various factors which block the flow of adequate communication in Indian organisations. Some of these may be applicable in both public and private sector, others might be relevant in the case of organisations of a particular type only; Some of these may be applicable for communication in all directions. Others might be applicable for communication in a particular direction only. Some of the important barriers of communication operating in Indian organisation are as follows:

(i) Indian organisations generally lack participation in decision - making. There are managers and entrepreneurs who are so authoritarian that they are not ready to listen to their top ranking managers, what to talk of lower level managers. They believe in order giving and not getting any feed back regarding how one feels about such orders. In such a case, there is not only the possibility of upward communication being inadequate but it affects downward communication also. This is so because upward communication also works as an energising function forward communication.

(ii) There is a tendency to centralise the authority at the top both in public and private sectors. In private sector, owners are always afraid to delegate authority. Similarly in public sector, ministers are always afraid to delegate power. They tend very much to take decisions themselves, Ministers' reluctance breeds the habit of reluctance in their secretaries to refuse delegation of power to their subordinates the same pattern is gradually being followed by the managing directors for their subordinates. This goes on and on, and steadily it becomes an



accepted practice. Centralisation of authority naturally follows more formal communication mostly for control and decision. In such a case, superiors keep their information requirements limited in order to avoid information for communication but also the quality of communication.

(iii) Indian organisations tend to be impersonal and bureaucratic.

This tendency is more applicable in the case of organisation belonging to old traditional industrial houses and public sector organisations. In such a setting, the organisation comes first, the individual is subordinate to the organisation. In a bureaucratic organisation, status differentials and class distinctions get overemphasised making interpersonal relationship amongst the executives highly impersonal and official. Communication being an interpersonal process, its smooth flow is adversely affected in the absence of close interpersonal relationship based on natural respect, trust, and confidence. The entire organisational processes in the public sector organisations in India are governed by bureaucratic model. Bureaucrat's overemphasis on the rules and regulations, his conservative temper and his insistence on rigid adherence to formalities, work against the smooth flow of communication.

(iv) The general organisational policy regarding upward communication acts as an overall guideline to every one in the organisation regarding how he is normally expected to behave in this matter. This policy might be in the form of an explicit declaration in writing, or as is more often the case, it has to be interpreted from the behaviour of organisation members, particularly people at the top. Since the above types of organisation emphasise on hierarchical system, often the communication does not flow adequately. This hierarchical system is governed by the span of control, unity of command, and unity of direction. The inherent weakness of this system is both delay and distortion in communication. Moreover, greater dependence of subordinates on their superiors for satisfaction of their needs refrains them from communicating upward, a number of subject-matter more particularly, messages, conveying unfavourable happenings in the organisation.

**12.9. Summary :** Efficiency and effectiveness of management depends upon effectiveness of communication also. In one way, there is no management when there is no proper communication. Free flow of communication is a sine-Quo-non, for the effective functioning of any organisation. Frankness and openness, on the part of lower levels of management must be developed, should and there be any Quality management for the information to reach all concerned people in the organisation, methods like : Participative Management, Quality Circles, TQM, MBO etc may be thought of.

#### 12.10. Key words :

1. **Communication :** It is transfer of some information, understanding, ideas, emotions, etc. from one person to another person and again from that another person to that one person who is first to inform.
2. **Barriers in Communication :** These are several disturbances that come in the way of effective communication.
3. **Non-Verbal Communication :** It is giving communication in a peculiar way. The peculiarity is that in body and various limbs of the body that express the message.
4. **Horizontal Communication :** This is also called lateral communication. This communication is between people of equal status.
5. **Diagonal Communication :** This is communication between unequals in different departments and sector in the same organisation for informal purposes.

6. **Informal Communication :** It is also a king of communication which doesn't appear in the formal organisation chart. It is not indicated any where. It is to be simply understood from the happenings in the organisation. So, it is communication that doesn't here adhere to the rules and principle of the organisational structure.

### 12.11. Self - Assessment Questions :

1. Explain communication process
2. What is effective communication?
3. What are the barriers of communication? How do you over come them?

### 12.12. Further Readings :

- \* Harold Knootz, Management
- \* James A Stoner, (et) al : Management
- \* VSP RAO and Hari Krishna : Management
- \* LM Prasad, Management

**Dr. G. Satyannarayana**

**Lesson - 13****LEADERSHIP**

**Objectives :** This lesson seeks to help you learn ;

- ☒ What is leadership?
- ☒ What are important Functions?
- ☒ What are Leadership styles?
- ☒ What are important Theories?
- ☒ How is Leadership in India?

**Structure :**

- 13.1 Introduction
- 13.2 Types of Leaders
- 13.3 Important Attributes
- 13.4 Important functions
- 13.5 Qualities of a Good Leader
- 13.6 Styles of Leadership
- 13.7 Theories on Leadership
- 13.8 Leadership in India
- 13.9 Summary
- 13.10 Key words
- 13.11 Self Assessment Questions
- 13.12 Further Readings

**13.1. Introduction**

This is the most interesting of all the areas in management. Effectiveness of management lies in good leadership qualities exhibited by the managers. All managers are leaders but all leaders may not be managers. Individual goal achievement and groups goals' achievement are all dependent upon leadership. All these goals are achieved only when leaders are able to win the willing co-operation of the members of the group.

Leadership is the art (or) influence (or) process of influencing people in order that they may strive hard willingly and enthusiastically towards the achievement of group goals. It is the process of directing and influencing the task related activities of the group members.

**Essense of leadership : [Koontz]**

Essense is followership. It is the willingness of the people to follow that makes a person a leader. People tend to follow those people whom they see as providing means of achieving their own desires, wants and needs.

**Stephen P. Robins :**

Leadership is the ability to influence a group towards the achievement of goals

**13.2. Types of leaders :**

Some leaders are called transformational and some are called transactional.

**(a) Transformational leaders :**

These leaders convert (or) change the position of their followers. They transform the status of subordinates from good to better and bad to good. Leaders influence and inspire their followers to achieve their group and personal goals. In that process, leaders stand through thick and thin and help the followers take to a right path to achieve the goals aimed at. These leaders do possess the following qualities:

- ◆ Independent
- ◆ Inspirational
- ◆ Achievement oriented
- ◆ Initiation
- ◆ Change oriented
- ◆ Proactive
- ◆ Influencing etc.,

**(b) Transactional leaders :**

This leader is a routine type leader. He transacts the routine business as a leader. He looks after the daily activities that he as a leader has to care for. His leadership is concerned with daily transactions in the organisation. In this process, he will clarify the role that the subordinate has to plan, makes the job clear, he gives needed instructions and guidance, he helps him do the job, he announces apt rewards for the performance, he measures the performance impartially etc. So, in this way, his leadership style is very much confined to only daily transactions. He may exhibit qualities like:

- Clarification giving
- Counselling
- Passive
- Directing
- Task oriented
- Practical
- Tangible etc.

**13.3 Important Attributes of Leadership**

- \* Leader have followers
- \* Leaders have emotional appeals and
- \* Leaders meet the needs of followers etc.



### **13.4. Important functions of Leadership :**

- \* Leader injects team spirit, confidence, ambition etc. into the minds of followers
- \* Leader is a representative of subordinates
- \* Leader is a counsellor, mediator, mentor etc., to the followers.
- \* Leader uses power for the best interests of the followers.
- \* Leader strives hard for leadership effectiveness
- \* Leader inspires and exhorts the followers.
- \* Leads seeks always willing co-operation of the subordinates/followers
- \* Leader furnishes a good working climate etc.,

### **13.5. Qualities of a Good Leader: Greatman theory on leadership**

This theory is an old one which holds that leaders are born but not made/developed. It tells further that successful leaders have some unique qualities because of which they go to called leaders. Another point brought to light by this approach is that great people are found only in some great families with unusual frequency and they may have a genetic reason for this also. Our world history (or) Indian history is very much abundant with examples of great leaders like : Sir Winston Churchill, Mahatma Gandhi, Julius Caesar, Jesus Christ, Alexander, Lal Bahadur Sashtri, Subash Chandra Bose, Alluri Sitarama Raju etc. So, some qualities may make a man, a leader. They are : Intelligence, good communication skills, emotional appeals, energy, human relations approach, convincing nature, patience, sincerety, transperency, committment, dedication etc.,

### **13.6 Leadership Styles:**

(Based on the use of Authority)

Leaders appear to be using three basic styles viz., Auto cratic, Democratic (or) Participative and free-rein

#### **13.6.1 Auto cratic style of leadership :**

This style is identified with the following :

- \* he commands
- \* he expects compliance
- \* he is dogmatic
- \* he leads with ability to withhold
- \* he gives rewards and punishments

- \* he holds power / authority for decision making
- \* he closely supervises and controls
- \* he makes his followers depend on him etc.,

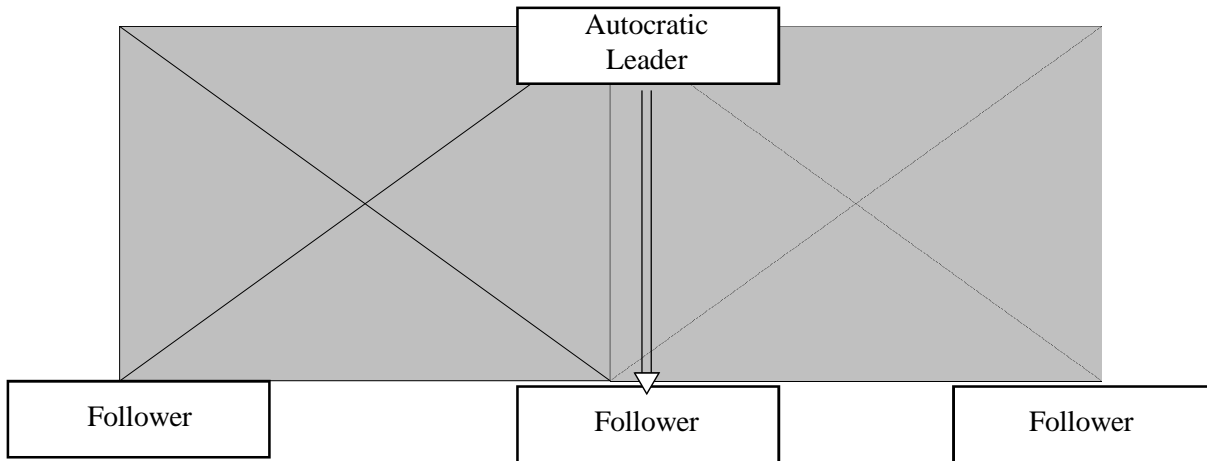

Figure 13.1 : Autocratic leadership style

**13.6.2. Democratic (or) Participate type :**

It is identified with the following :

- \* there are consultations
- \* encourages participation
- \* joint decision making
- \* feelings, attitudes, suggestions of subordinates are considered.
- \* communication is two way etc.,

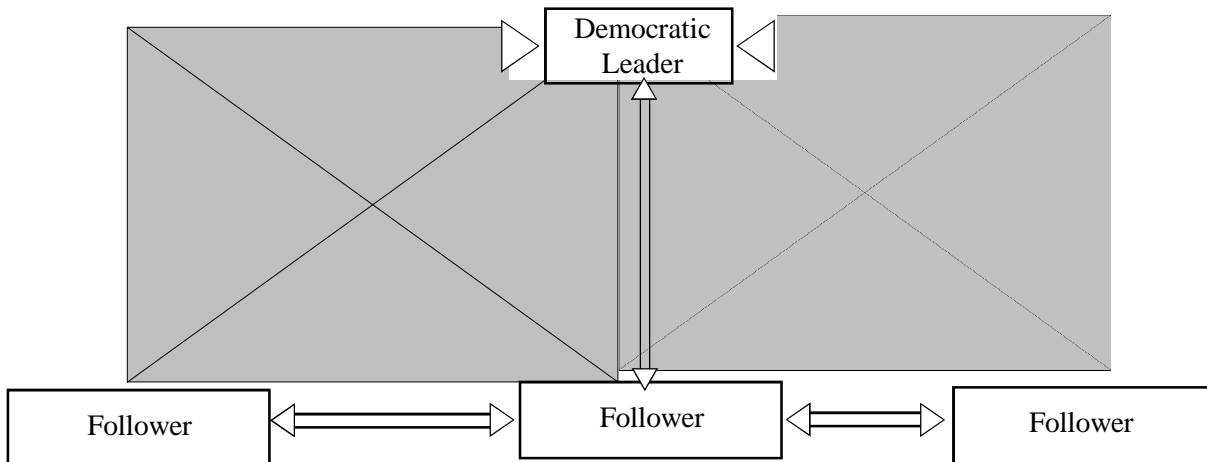
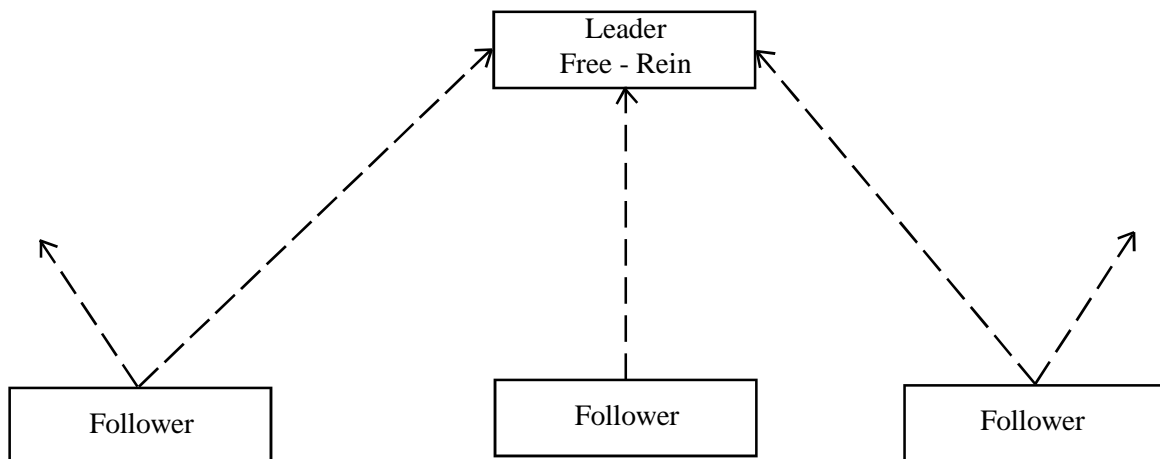

Figure 13.2 : Democratic leadership style

### 13.6.3. Free-Rein leadership style :

The following help us identify this from others :

- \* leader uses very little power
- \* high degree of independence is there on followers
- \* leaders largely depend upon followers
- \* leader's role is one of aiding
- \* leader is passive observer
- \* leader abdicates responsibility.
- \* followers operate in an unrestricted environment.
- \* communication can take any direction (figure explains this best).



**Figure 13.3 :** Free-Rein leadership style

----- → This dotted line is flow of communication

## 13.7 Approaches/Theories on leadership :

The available literature on leadership relating to approaches to understand leadership, can be fairly distributed under three possible headings viz., Traits approach, Behavioural approach and contingency (or) situational approach.

### 13.7.1 Traits Approach :

This approach seeks to distinguish leaders from non-leaders, based on qualities and traits of the individuals. In this regard, great man theory as leadership, discussed in the earlier sections is very much useful. There are certain traits that make a man a leader. Others, in the absence of these traits can't become leaders. This says

further that leaders are born but not made. In this context, Ralph M. Stogdill found that there are five (5) kinds of traits, based on the research conducted on traits. The following are the classified traits that made people leaders.

- \* Five (5) Physical traits viz., energy, appearance, height etc.
- \* Four (4) Intelligence and ability traits
- \* Sixteen (16) personality traits like: adaptability, aggressiveness, enthusiasm etc.
- \* Six (6) Task-related traits like : Achievement drive, persistence, initiative etc.
- \* Nine (9) Social Traits like: Co-operativeness, interpersonal skills, Administration ability etc.

Thus, the argument goes that people become leaders when they possess these traits. Of course, this was challenged by several researchers.

### 13.7.2. Behavioural Approach:

This line of thought on leadership opines that some behavioural patterns or styles do differentiate leaders from non-leaders.

Much research is there over this area as several Universities became research centres for studying these leadership styles. Important works are :

1. Ohio state University studies.
2. IOWA University studies.
3. Michigan University studies
4. Scandinavian studies etc.

### 13.7.3. Rensis Likert's Four Systems :

One research work relating to Rensis Likert, in Michigan University is a popular one which introduces 4 (four) systems towards leadership styles as under :

- \* System I is Autocratic Style
- \* System II is Benevolent - autocratic style
- \* System III is Participative Style
- \* System IV is Democratic Style

These systems are briefly explained in a comparative way in the following sections.

#### Rensis Likert's Four system

System I	System II	System III	System IV
* Highly Autocratic	* Patronising confidence	* Substantial confi-	* Complete Trust
* No trust	* More rewards	dence in followers	* Uses the suggestions



* Punishments used to get things done	* Limited Punishments	* Usually collects ideas	* Fair and conomic rewards
* No rewards	* Permits upward Communications	* Mostly rewards	* free flow of Communication
* Only down ward Communications	* Solicits ideas from followers	* Upward and down ward communication	* Collective Adminis-
* Decesion making at the topt etc.	* Some delegation with control etc.,	* Decision making both at top and bottom	* tration and decision making
		* Much consultation etc.,	

An important research work in Ohio and Michigan University studies related to Managerial Grid, developed by Blake and Mouton and another model by name “Continuum of Manager - Non manager behaviour by Tannenbaum and Schmidt” are discussed in the following sections.

#### 13.7.4. Managerial Grid (Blake and Mouton’s Model)

The following figure shows the degrees of concern for production and people and possible interactions between them. On the X axis, “Concern for production” is indicated while “concern for people” is represented on the Y axis. 1 (One) is considered minimum while 9 (Nine) is considered maximum on the continuum. Totally, there are as many as 81 leadership styles but the most prominent ones are only five (5) in number. From this model, five (5) leadership styles emerge.

##### (i) Impoverished Leadership Style (1,1) :

- \* this leader has a little concern for both production and people.
- \* Idea of this style is that exertion of minimum effort is required to get things done and to sustain organisational morale.

##### (ii) Country club leadership style (1, 9) :

- \* This style reflects minimum concern for production and maximum concern for people.
- \* Idea is that thoughtful attention to needs of people for satisfying relationships leads to a comfortable, friendly organisation atmosphere and work tempo.

##### (iii) Task leadership Style (9, 1) :

- \* This style is mainly concerned with production and attaining maximum production at all costs.
- \* Showing minimum concern for people and maximum concern for production.

- \* Idea in this is that efficiency in organisations results from arranging conditions of work in such a way that human elements interfere to a minimum degree.

**(iv) Team leadership Style (9, 9) :**

- \* This style is considered best and ideal one as there are maximum concern for production and people as well.
- \* Idea of this style is that Work accomplishment is associated with commitment at work.
- \* These people are the real team managers who are able to mesh the production needs of the organisation with the needs of human elements.

**(v) Middle of the road leadership style (5, 5):**

- \* This style reflects a very moderate concern both for people and production.
- \* Theme of this style is that adequate organisation performance is possible through balancing the necessity to get work with maintaining morale of people at a satisfactory level.

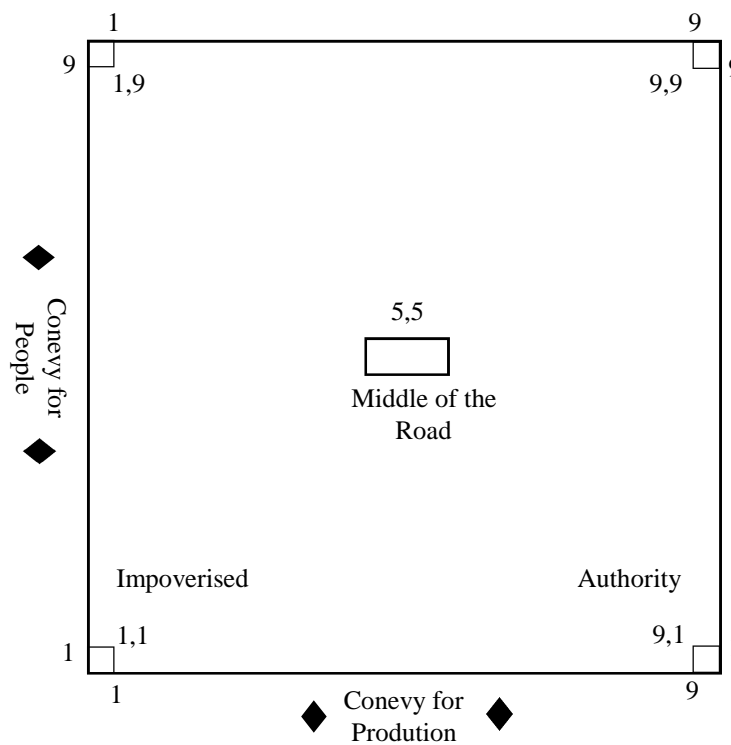

**Figure 13.4 :** Blake and Mouton's Managerial Grid

**13.7.5. Continuum of Manager - Non Manager Behaviour (Robert Tannenbaum and Warren H-Schmidt)**

In this model, leadership styles (or) behavioural patterns range from “Boss centred” to “employee centred”. The following figure describes it best.

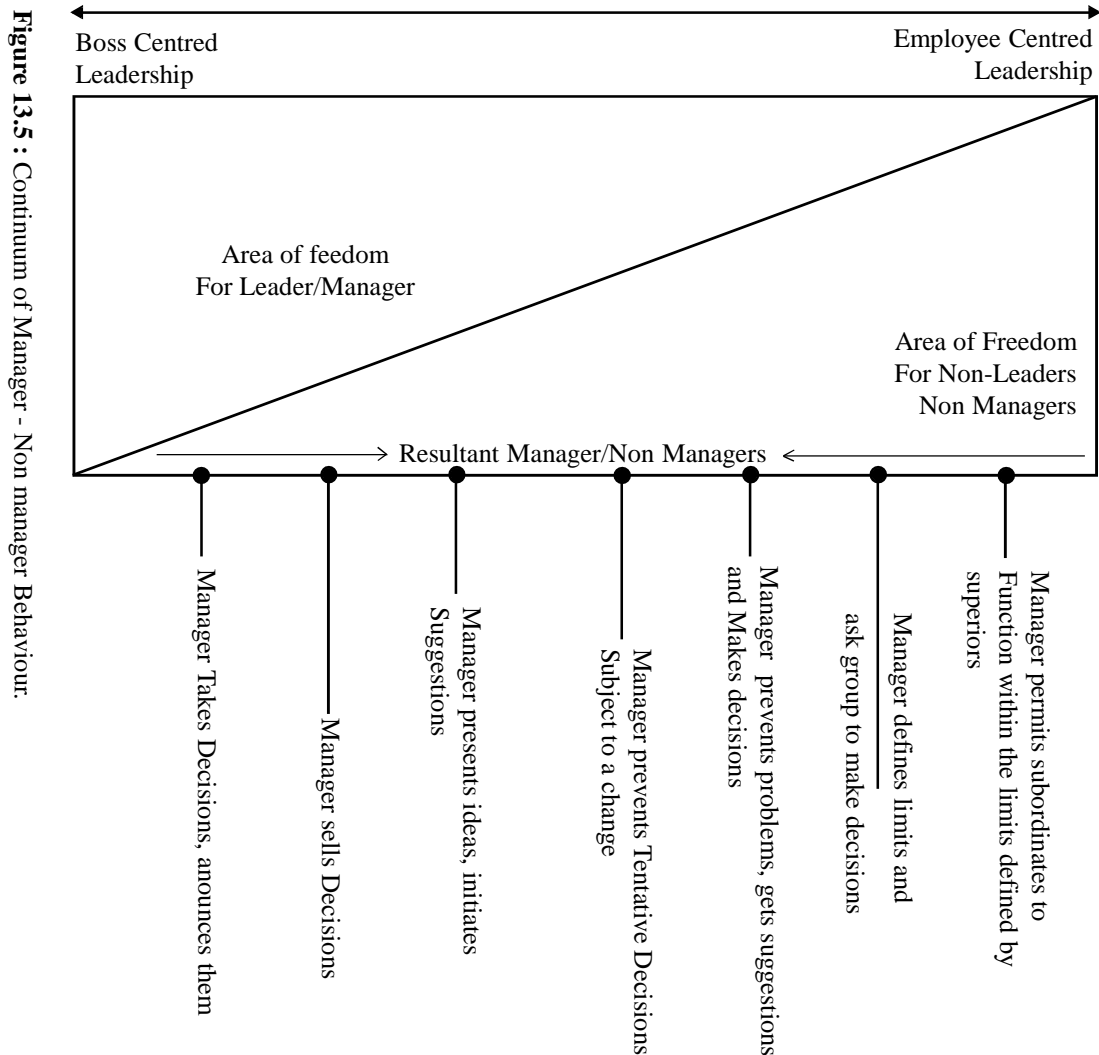

The styles of leadership depend upon the degree (or) level of freedom that leader grants to the followers. This model gives only a range of styles instead of giving some styles specifically. The real style that is operative is influenced by three important factors viz., leader, follower and situation.

- Leader :** The value system of the leader, his confidence in his subordinates, his leadership styles, his degree of tolerance of the ambiguity etc. do form part of the forces that influence a leader
- Followers :** Need for independence, level of tolerance of ambiguity, readiness to shoulder responsibility for decision making, understanding and identifying organisational goals etc. are various forces that influence the employees.
- Situation :** This is about the contingency, problem, situation etc which gives rise to a particular leadership style.

In one way, this model on leadership claims to be better as it says that the leader changes in accordance with changes in situation.

### **13.7.6. Contingency Approach (Situational approach) :**

This approach tells that leadership is situational. Hence it differ situation to situation.

There are several research works under this area to study leadership. The most important ones mentioned here are one discussed in the following sections.

- (a) Path Goal leadership theory by Robert House
- (b) Hersey and Blanchard's Model

#### **(a) Path Goal leadership Theory (Martin Evans and Robert House)**

This Contingency model on leadership seeks to tell that leader attempts to make the path to goals, smoother and easier. But to accomplish this path-goal-facilitation, the leader must use appropriate style based on situational variables present. Four major styles of leadership introduced by this theory are : Directing, supportive, participative, and achievement oriented :

- **Directing :**

- \* Followers (or), Subordinates know what is expected of them.
- \* Leader gives specific directions
- \* There is no participation from followers

- **Supporting :**

- \* Leader is friendly
- \* He is approachable
- \* He Shows genuine concern for followers

- **Participative :**

- \* Leader asks for suggestions from subordinates / followers.
- \* He uses the suggestions offered
- \* He makes then decisions.

- **Achievement oriented :**

- \* Leader sets challenging goals
- \* He sees and shows confidence in his followers that they will attain goals and will perform well

### Situational Factors :

In this situational Theory, two situational factors identified are :

#### (i) Personal Characteristics of followers :

Leader behaviour is acceptable to the extent that it is an immediate source of satisfaction (or) it is instrumental for future satisfaction.

#### (ii) Environmental pressures and demands facing subordinates/Followers :

Leader behaviour is acceptable to the extent that it compliments and supplants the environment of subordinates by providing coaching, guidance, support, rewards etc., necessary for effective performance which otherwise are not available in their environment.

As said in the earlier paragraph, leader steps into right shoes of leadership in accordance with the situational factors. It implies that there is relation between leadership style and situational aspects. Effects leadership is that one which agrees with (or) is suitable to the situation.

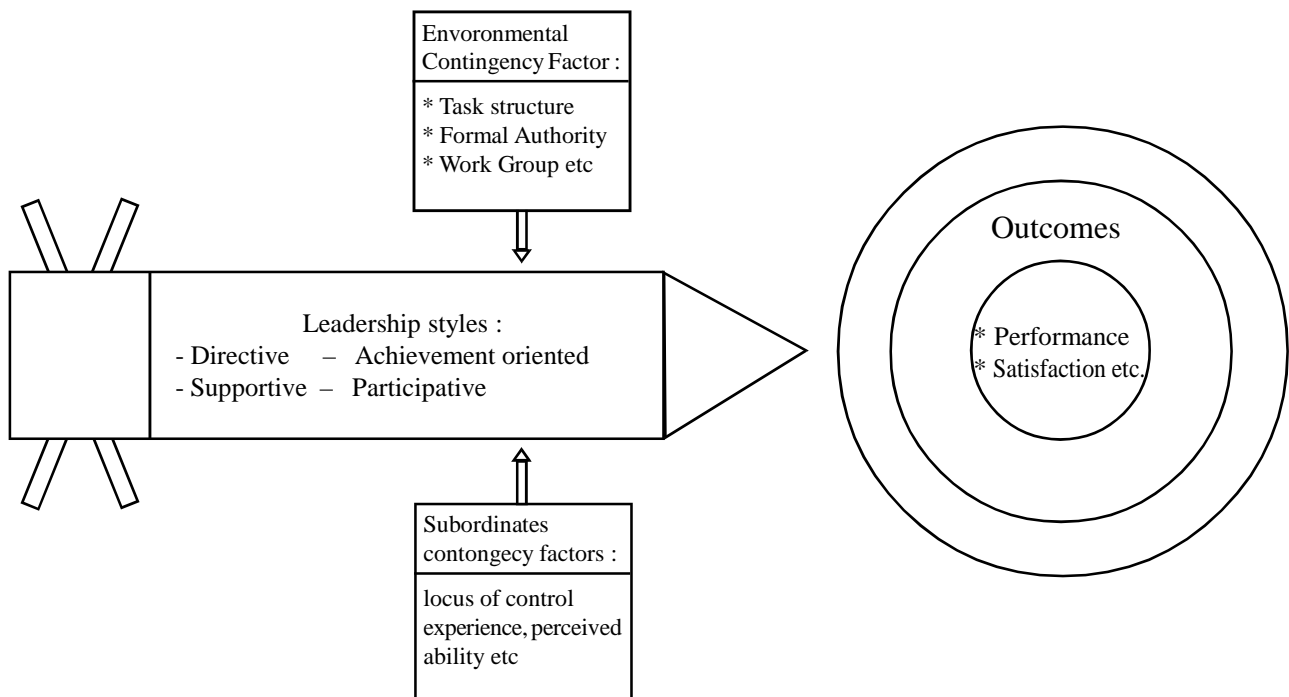

**Figure 13.6 :** Path Goal Leadership

Source : [Stephen P. Robins P. 428]



### (b) Hersey and Blanchard's Situational (or) contingency Model on Leadership.

This is another important situational theory. This closely resembles managerial grid of Blake and Mouton. Some additional situational aspects relating to “maturity levels of followers” are considered. Here also, leadership style will be in consonance with situation relating to maturity of subordinates. Both styles of leadership and maturity level are briefly explained.

Leadership Styles proposed :

#### ● Telling :

- \* Leader defines roles
- \* leader tells people about: what, how, where, when to do?
- \* He is all directive etc.,

#### ● Selling :

- \* Leader is both directive and supportive, etc

#### ● Participating :

- \* Leader shares in decision making
- \* He facilitates
- \* He communicates etc.,

#### ● Delegating :

- \* Little direction
- \* Little support
- \* So, practically no guidance

### Maturity levels as situational factors : (of Followers)

#### \* R1 Least matured :

- \* Unable and unwilling to take up responsibility
- \* NA Competent

#### \* R2 Less Matured :

- \* People are unable but willing to do job.
- \* they lack in skills needed

**\* R3 More Matured :**

- \* People are able but unwilling to do what the leader wants

**\* R4 Most Matured :**

- \* People are willing and are able to do what is expected of them.
- \* They are able to manage themselves etc.

**What does this maturity mean?**

- \* It is some what followers' readiness related to job and it is psychological
- \* It is ability to perform the task and willingness to shoulder the responsibility.

Theory is understandable from the following table which depicts suitable leadership styles to various maturity levels and the figure in the next page.

Leadership Styles	Maturity Levels (situational factors)
* Telling suitable to →	* R1, the least matured
* Selling suitable to →	* R2, Less matured
* Participating suitable to →	* R3, More matured
* Delegating suitable to →	* R4, Most matured

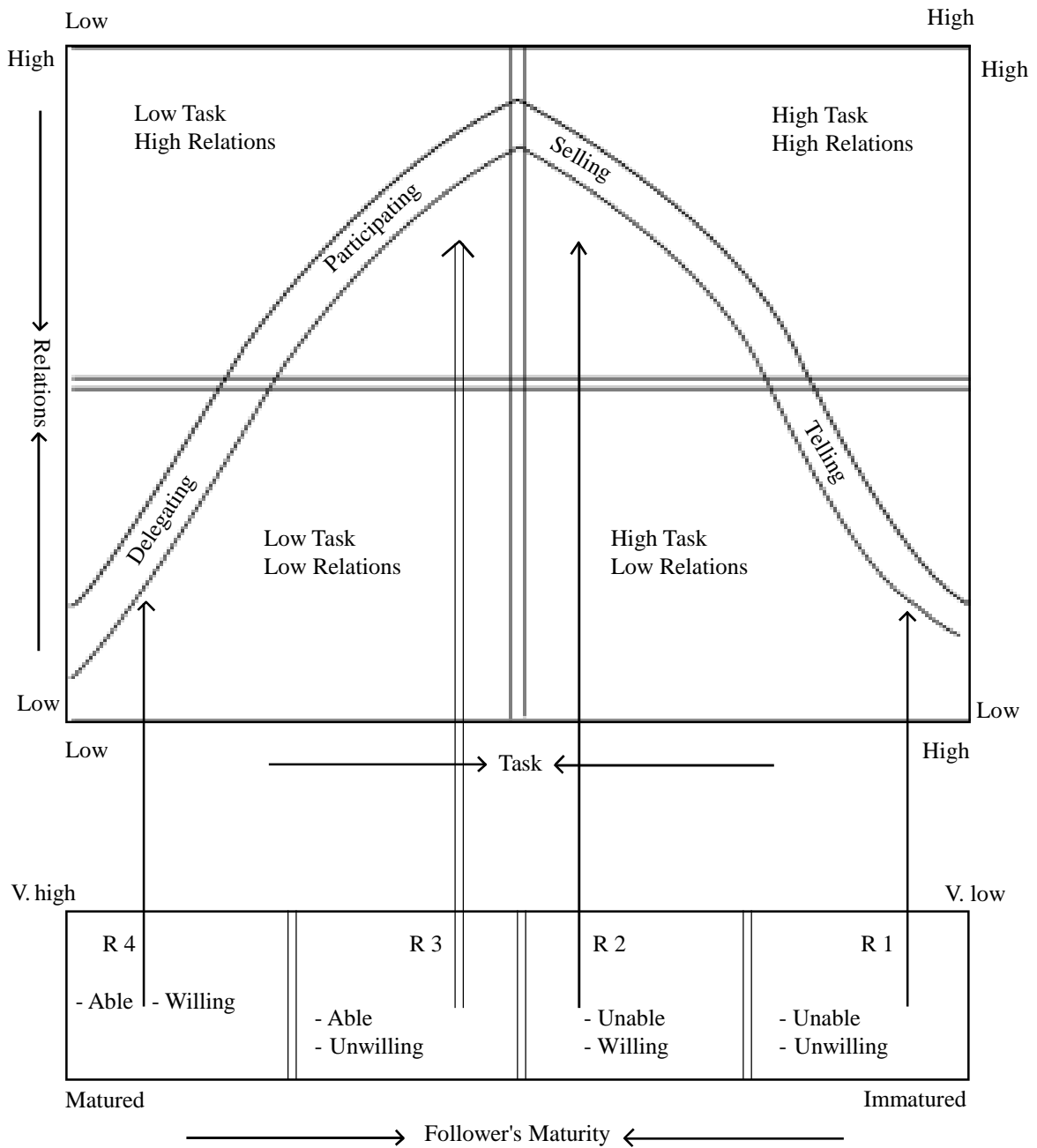

**Figure :13.7**  
**Hersey and Blanchard**  
**Situational model**

**13.7.7. Fiedler's Contingency Model :** Fiedler's contingency model of leadership has the basic contention that the appropriateness of leadership styles depends on their matching with situational requirement. Taking clues from the situational approach that leadership effectiveness is situational. Fiedler alongwith his associates made an attempt to identify the situational variables and their relationship with appropriateness of leadership styles. Fiedler's model consists of three elements : leadership style, situational variables, and their interrelationship.

**Leadership Styles :** Fiedler has identified leadership styles on two dimentions: task-directed and human relations oriented. Task-directed style is primarily concerned with the achievement of task performance. The leader derives satisfaction out of the task performance. Human relations style is concerned with achieving good interpersonal relations and achieving a position of personal prominence. Fielder used two types of scores to measure the style adopted by a leader : scores on least preferred co-worker (LPC) and scores on assumed similarity (AS) between opposites. Rating on least preferred coworker was based on an individuals' liking or disliking of working with other individuals in the group and measured on sixteen items such as pleasant-unpleasant, friendly- unfriendly, accepting-rejecting, and so on. Rating on assumed similarity was based on the degree to which leaders received group members to be like themselves. The scores on two ratings had very high positive correlation.

**Situational Variables :** Though there may be many situational factors affecting leadership effectiveness (discussed in the previous section), Fiedler has identified three critical dimensions of situation which affect a leader's most effective style. These are leaders position power, task structure and leader-member relations.

**Leader's Position Power :** This is determined by the degree to which a leader derives power from the position held by him in the organisation which enables him to influence the behaviour of others. In the case of a manager, it is authority delegated to him. As Fiedler points out, a leader with a clear and considerable position power can more easily obtain followership than one without such power.

**Task Structure :** Task structure refers to the degree to which the task requirements are clearly defined in terms of task objectives, processes and relationship with other tasks. When the tasks are clear, the quality of performance can be more easily controlled, and group members can be held responsible for performance than tasks are unclear.

**Leader-Member Relations :** It refers the degree to which followers have confidence, trust, and respect in the leader. Fielder has considered this dimensions as the most important for the leader as his position power and task structure are subject to control by the organisation and these can be prescribed, However, the leader has to build his relations with the group members on his own. If the group members have positive thoughts about the leader, leadership would be more effective.

All these situational variables taken together may define the situation to be favourable or unfavourable.

Favourableness or unfavourableness of the situation has been presented in Figure.

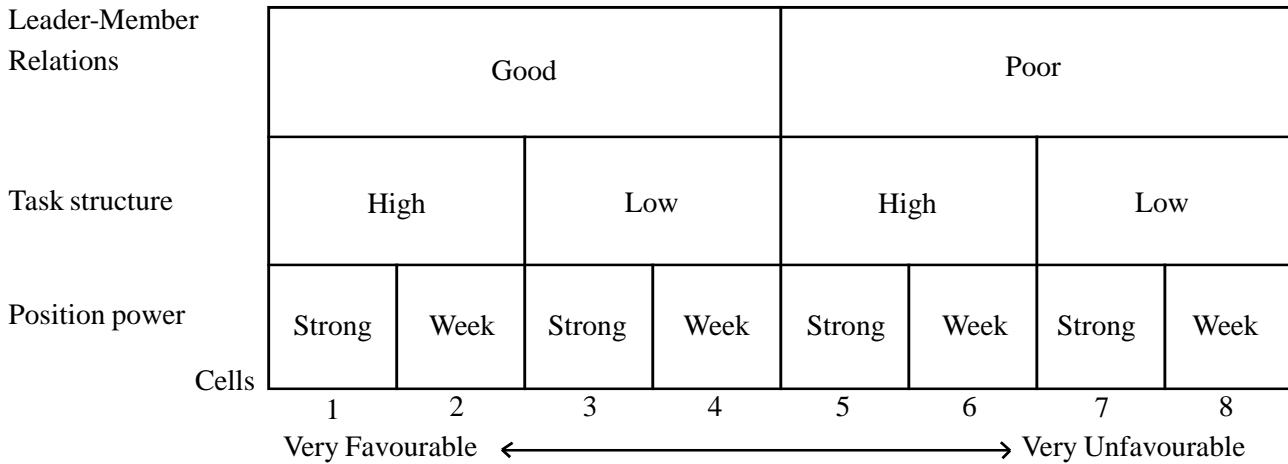

Figure 13.8 : Favourable and Unfavourableness of Situation

A very favourable situation is one (cell 1) where leader-member relations are good., task is highly structured, and the leader has enormous position power to influence his subordinated. At the other extreme, a very unfavourable situation is one (cell 8) where leader-member relations are poor, task is highly unstructured and leader's position power is weak. Between these two extremes, the degree of favourableness/ unfavourableness varies.

**Relation between Styles and Situation :** Fielder feels that the effectiveness of leadership style depends on the situation. For example, he says that :

"the group performance will be contingent upon the appropriate matching of leadership style and the degree of favourableness of the group situation for the leader, that is, the degree to which the situation provides opportunities to the leader to influence his group members".

Appropriateness of leadership styles in different situations has presented in Figure

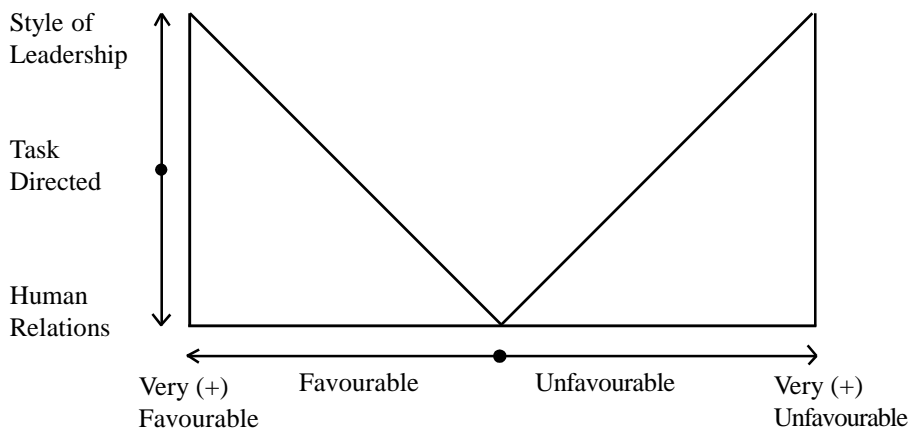

Figure 13.9 : Fiedler Model of Leadership



Thus, task-directed and human relations-oriented styles tend to be effective in different situations.

- ℳ Task-directed leadership style tends to be better in group situations that are either very unfavourable or very unfavourable to the leader.
- ℳ Human relations-oriented leadership style tends to be in group situations that are intermediate in favourableness.

The reason for this phenomenon has been provided by Fielder. He says that;

"In the very favourable conditions in which the leader has power, informal backing, and a relatively well-structured task, the group is ready to be directed, and the group expects to be told what to do. Consider the captain of an airliner in its final landing approach. We would hardly want him to turn to his crew for a discussion on how to land".

As an example of why the task-oriented leader is successful in a highly unfavourable situation, Fielder has cited that :

"... the disliked chairman of a volunteer committee which is asked to plan the office picnic on a beautiful Sunday. If the leader asks too many questions about what the group ought to do or how he should proceed, he is likely to be told that we ought to go home".

The leader who makes a wrong decision in this highly unfavourable situation is better off than the leader who makes no decision at all. Similarly, human relations leader is more effective in intermediate range of favourableness of situation because he can get the work done by using his interpersonal skills more than insisting on the work itself. An example of such a situation is the typical committee or a unit which is staffed by professionals. In such a situation, the group members may not wholly accept the leader, the task may not be completely structured, and the leader may not have adequate authority; he had to rely more on persuasion and interpersonal relations to get the work done.

**Implications of Fielder's Model :** Fielder's model offers a number of implications. The model provides a promising break through in leadership research. Various research studies in leadership have been conducted based on this model and they support the model. It has been commented that this model is and will probably remain a rich source of leadership and its effectiveness. From the viewpoint of organisational implications, Fielder's Model offers two implications.

- (i) No leadership style is appropriate for all situations. Therefore, there is nothing like the best style. The managers can adopt the leadership styles according to the requirements of the situations.

- (ii) There is a need for matching leaders and job situations to achieve organisational effectiveness. Fiedler says that "if we wish to increase organisational and group effectiveness, we must learn not only how to train leaders more effectively but also how to build an organisational environment in which the leader can perform well".

**13.8. Leadership Styles in Indian Organisations :** In the first instance, Indian management is generally believed to be autocratic with subordinates closely supervised by their superiors and only a limited degree of participation is allowed to the subordinates. However, the real situation in this context can be appreciated only when a detailed account of various practices is taken for consideration. Fortunately, some empirical studies are available in this context which do not necessarily support the traditional view rather they present a mixed note.

The review of various studies fails to give a generalised result. The findings are too diverse, sometimes even contradictory. It indicates the absence of a clear-cut direction in the managerial conviction and values. Since, managerial styles are determined by a host of factors such as forces in superiors, subordinates, and situations, it is unlikely to expect a uniform leadership style. Such classification may be (i) family-managed traditional organisations, (ii) professionally managed Indian organisation and foreign-owned organisations, and (iii) Public sector organisations.

In family-managed traditional organisations, and most prevalent style is autocratic. Sons and grandsons of the entrepreneurs are automatically promoted without any consideration to efficiency or overall suitability. Thus, There is management by inheritance or management by chromosomes with the result that these organisations are highly centralised in their organisations structure and are authoritarian in their approach. In many such organisations, a certain amount of the paternalistic attitude prevails. The proprietary character of business and large scale participation of family members in it have made the attitude of the head of the business, who is also the head of the family, highly paternalistic. The same paternalistic attitude extends to the employees and has developed a set of values in an employer vis-a-vis his employees. At the initial stage, authoritarian style is more suitable which these organisations have followed. However, such style has also been inherited by successors without any appreciable change or modification. On the other hand, there are many organisations in the private sector owned by Indians or by multinationals who have appreciable degree of participation or democratic leadership. The reason is that multinationals do not bring only their technology but also the work culture which is more permissive and conducive towards the application of modern approach of management. As such, the degree of participation is greater in such organisations. The third category of organisations is in public sector, Here, bureaucratic style is more prevalent owing to the work culture inherited by public sector managers. Initially, public sector organisations were manned by civil servants who brought a lot of bureaucratic culture with them. The net result is that the entire organisational processes are governed by bureaucratic model. Its implication is status differentials, class distinctions, and impersonal relationships which work against participative style.

**The Right Style :** What is a right leadership style for Indian managers is a difficult question to be answered? One often comes across a futile search for a style appropriate for Indian managers. There are numerous variables which affect the leadership style. Thus, what may appear to be an effective leadership style for a manager, may not be equally appropriate to others. The important variables in this context are superiors, subordinates, and the situation under which a particular style is followed. The analysis of these variables may throw some light upon the adoption of appropriate style.

**(a) Indian Society :** Indian society is generally considered to be a traditional one. In such a society, power and authority is considered an important characteristic. There are three important aspects of Indian society, viz., joint family, caste system, and ritualism. The value inherent in the joint family are responsible for generating authoritarian attitudes. Respect for power and authority is installed by the family system beginning in childhood, with the head of the family exercising absolute authority over other members of the family. It is believed that this respect for authority spreads through every type of social system including work organisations. The authority of superiors at work-place was specially exaggerated during the British colonial period when British Superiors exhibited a high degree of authority in their behaviour towards Indian subordinates. Similarly, caste system is emphasised so much that it creates conflicts between two different castes. Besides, there are many rituals in the Indian society. They reduce anxiety, like other given ways of doing things provided by tradition and society. These rituals help in the smooth functioning of a system or an organisation, and reduce anxiety and tension relating to new situations. They also prevent the development of the exercise of discretion and the power of decision-making in situations of uncertainty.

The above discussion does not mean that traditionalism is the only guiding force in our society. The industrialisation has entailed many changes in the social and cultural life of people. The rituals that society had developed to deal with the problems of growth and to cope with the anxiety and tension are no longer appropriate in a technological change. In industrial society, the rate of change is very high. Its implication for managers is living in a environment which is full of changes and uncertainty. Such circumstances demand greater consultation and participation on the part of managers. Thus, the changing situation is more suitable for participative style.

**(b) Indian Managers :** There is no uniformity in the attitude, personality and educational background of Indian managers. We find the just literate top managers along with fully qualified professional managers. naturally, leadership style may present two extreme ends. The former group of managers perceive themselves self-developed and self-contained. As such, they present very little scope for participation. On the other hand, young professional managers have more interdependence and apply more integrated approach. Hence, they are likely to follow and expect of others a more democratic approach. The satisfaction of such managerial class seems to depend on the degree of responsibility, trust, etc. They are prepared to delegate, train, and be employee-oriented but find organisational climate inhabiting such orientation.

considering these variables, the appropriate style may be near participative leadership. A manager should be not necessarily adopt his style for the present situation only, but his ought to look into future too ... Many of the restraining forces for participation may be subsided by the facilitating forces. There are certain perceptible changes that require greater participation. Unionism at work place, professionalisation of management, rapid industrial growth and technological changes demand for more autonomy and interdisciplinary approach by new generation and democratic way of living having demanded more participation. Therefore, a move towards participative style has already begun in enlightened companies in India. There are various such organisations in public sector and private sector in India following such style. Situations prone to authoritarian may be only to the tune of 20 percent. Abnormal situation may exist only to the tune of 10 percent. So a manager should go for 80-90 percent cases. However, it should not be taken for granted that this style may be suitable in all circumstances. A particular may be changed to suit participative style because authoritarian work culture is unlikely to succeed in the future. The above discussion presents the view of leadership styles followed by Indian Managers.

**13.9. Summary :** Good leadership makes an organisation a dynamic organisation. He has to win the willing co-operation of his followers. He should strive hard, with his team members, to help the organisation achieve the organisational goals. He has to be situational and accordingly, he has to lead. Of all the styles of leadership, participative (or) democratic style yields best results, Hence, leader and Leadership are very vital to the well-being of the organisation.

### 13.10. Key words

1. **Leadership :** Leadership is the process of directing and influencing the task related activities of the group members.
2. **Transformational leaders :** These leaders convert or change the positions of the followers. They transform the status of subordinates from good to better and bad to good.
3. **Transactional Leaders :** This leader is a routine type leader. He transacts the routine business as a leader. He looks after the daily activities that he as a leader has to care for. His leadership is concerned with daily transactions in the organisation.
4. **Traits Approach :** This approach seeks to distinguish leaders from non leaders, based on the qualities and traits of the individuals.
5. **Behavioural Approach :** This line of thought on leadership opines that some behavioural patterns or styles do differentiate leaders from non-leaders.

6. **Contingency Approach** : This approach tells that leadership is situational. Hence, it differs from situation to situation.
7. **Path - Goal leadership Theory** : This contingency model on leadership seeks to tell that leader attempts to make the path to goals, smoother and easier.

### 13.11. Self Assessment Questions :

1. How do you explain leader and leadership?
2. What are leadership styles?  
What do you advocate as the best in general?
3. What do contingency theories on leadership tell? Explain any one theory.

### 13.12. Further Readings :

- \* Harold Knootz and Heinz Wehrich, Management Global Perspective. Tata Mc Graw Hill Publishers, New Delhi.
- \* James A Stoner, (et) al, Management, Prentice Hall of India, New Delhi.
- \* VSP Rao and V. Hari Krishna, Management Text and Cases, Excell Publishers, New Delhi.
- \* LM Prasad, Management Principles and practices, Sultan Chand & Sons, New Delhi.

**Dr. G. Satyannarayana**



**Lesson - 14****CONTROLLING**

**Objectives :** This lesson seeks to help you learn :

- ☒ the concept of controlling
- ☒ process of controlling
- ☒ essentials of effective controlling system
- ☒ modern methods of controlling

**Structure :**

- 14.1 Introduction
- 14.2 Features
- 14.3 Process
- 14.4 Essentials
- 14.5 Reporting System
- 14.6 Modern Control Techniques
- 14.7 Summary
- 14.8 Key Words
- 14.9 Self-assessment Questions
- 14.10 Further Readings

**14.1. Introduction :**

Controlling is the last managerial function. It is one of the two inseparable functions in management being planning and controlling. These two functions are inseparable as planning doesn't meet its purpose without controlling while controlling can't achieve its goal without the assistance of planning and its components. So, very important managerial function is controlling though it is the last one.

- \* It is making a review.
- \* It is an investigation and audit.
- \* It is looking back once to checkup.
- \* It is making a comparison between two important aspects viz., actuals and standards, to find out whether the actuals are at variance with standards (or) not.

- \* Thus, controlling is the process of comparing actual performance with standard performance to find out the degree of variance, find out causative factors, analyse them into controllable and uncontrollable and then, to control the controllables.
- \* Hence, controlling is taking a remedial action (or) corrective measure on knowing that things are not moving as per the plan.

### 14.2 Features :

- \* Controlling is a continuous process but not an ad-hoc one.
- \* It is forward looking.
- \* It is sine - quo - non for any organisation.
- \* It is dynamic.
- \* Controlling is goal oriented.
- \* Delegation is an important key to controlling.
- \* Starting point for controlling is planning.

### 14.3 Process of Controlling :

This is a step by step process. The following are the steps.

- \* Establishment of standards for performance.
- \* Establishment of standard criteria to measure performance.
- \* Measurement of actual performance.
- \* Comparing actual performance with standard performance.
- \* Finding out the difference between.
- \* This difference is called variance.
- \* Naming this variance into profitable variance or unprofitable one.
- \* Knowing about the reasons both for profitable and unprofitable variances.
- \* Analysis of the causes, into controllable causes and uncontrollable causes, when, the variances happen to be adverse variances.
- \* Concentrating on un-controllable and un-manageable causes is of no avail in management.  
Eg. Losses due to heavy rains, Earth Quakes, Floods etc. are uncontrollable by human action.
- \* Controlling the controllables. This means that the people responsible for this state of affairs are made answerable through Responsibility Accounting.
- \* Controlling over past and present is nothing. Controlling means controlling future only. This is nothing but taking every care to see that the history does'nt repeat.

- \* Thus, a remedial action is taken.
- \* If necessary, standards laid already are revised. Again, the ball is kept rolling. The process goes forward.
- \* Briefly, the process is described best by the following figure :

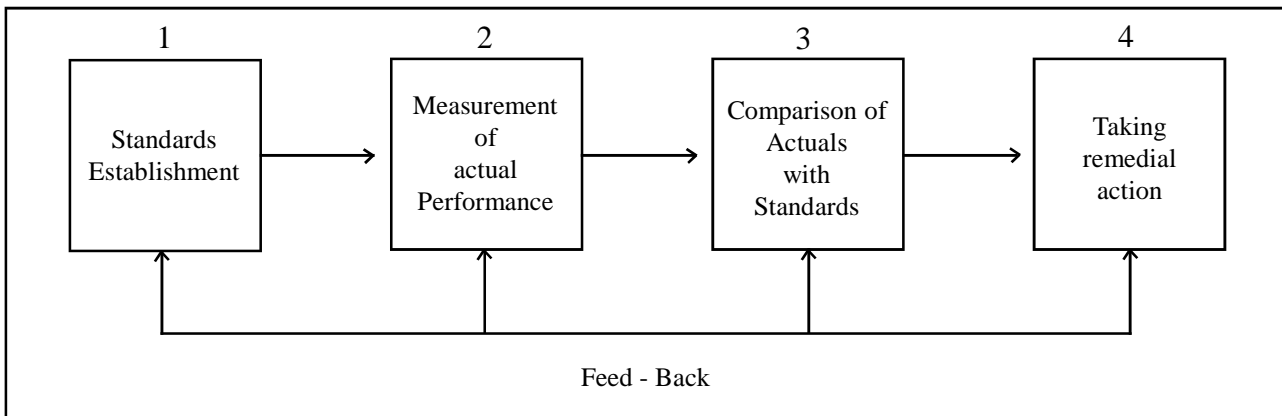

**Figure 14.1 :** Controlling Process

#### 14.4. Essentials for Efficient and Effective Controll Process :

- \* The system designed must be a suitable one.
- \* It must be too simple to be understood.
- \* It must be sound, valid and economic.
- \* Very important one is that it must be flexible and revised in response to changes.
- \* Standards fixed must be reasonable, practical, objective, clear, verifiable etc.
- \* Good system of responsibility accounting must be in operation.
- \* Standard costing and budgetary controll techniques like techniques must be installed.

#### 14.5. Communicating and Reporting System for Controlling :

Reporting information for controlling purpose is a special task and a seperate system is sought to be developed. This is mostly upward communication.

How should it be?

- \* It is often impeded by the managers in the heirarchy.
- \* They filter the information and do not send all to the top for controlling.
- \* Especially, unfavourable news to the bosses is not allowed to be reported.

- \* Upper level people require a lot of information about several aspects of the lower levels for monitoring purposes.
- \* But, pitiable thing is that people to call a spade, a spade, are very rare and scarce.
- \* Upward communications is seen in an environment where there is democratic and participative managements.
- \* Effective upward communication requires an environment in which, subordinates feel free to communicate. Since organisational climate is something influenced by the upper management, the responsibility for creating a free flow of upward communication rests with superiors.
- \* Concepts of Ombuds person, whistle blower, M.B.E. etc. may be thought of.
- \* An organisational atmosphere full of frankness, freedom, openness, transparency, truthfulness, etc. is very much essential, should any meaningful and useful information be reported to the higher ups for the managerial control.

## 14.6 Modern Control Techniques

There are several modern controlling tools as under :

- 14.6.1. Zero Base Budgeting (ZBB)
- 14.6.2. Budgetary Control
- 14.6.3. Performance Budgeting
- 14.6.4. Responsibility Accounting
- 14.6.5. Break Even Analysis
- 14.6.6. Human Resource Accounting
- 14.6.7. PERT and CPM
- 14.6.8. Total Quality Management etc.

### 14.6.1 Zero Based Budgeting (Z.B.B.) :

This is one of the several modern tools to controlling. This was used in America in 1962 by Jimmy Carter, the former President of USA, for controlling the Expenditure of Georgia State in USA, while he was Governor of that state.

Meaning :

It is a budget prepared with zero (0) as the base. "No base" is the base for this budget preparation.

**Normal Practice :**

History is the most important basis for the preparation of budget at any point of time. Often, we tend to say that history repeats. Past figures and records are used to prepare budget for the next period. Approach that is adopted is incremental approach. Since normal preparation of any fresh budget does result in rises of costs at several levels, the approach is qualified as "incremental approach".

**Risk in the normal Practice :**

The flaws, loopholes, mistakes, inefficiencies etc., in the past, will simply be carried forward when things of the past are taken as they were indiscriminately, without making any further checking. That is why people are now searching for a good way-out.

**Solution offered :**

The solution offered here is Z.B.B. Every year for which, a budget is sought to be prepared is considered as a fresh year. Previous records are not touched upon and consulted. The costs and revenues are to be justified as per the present and future needs. So, base is hundred percent Zero (0). One has to do one's job sincerely starting from A.B.C.Ds..... of that. The onus of responsibility to say that he requires more funds to be allocated to a particular decision package (or) area to be budgeted, it is he that has to offer convincing explanation.

**Benefits of Z.B.B. :**

- \* Scarce funds are best utilised.
- \* Efficiency and effectiveness of management improves.
- \* Wastages and inefficiencies are very much weeded out.
- \* Basis for allocations of funds is not past but the present strong convincing justification.

**Limitations :**

- \* Risk of resistance to change
- \* Z.B.B. also is like any other fixed budget offering least flexibility.
- \* Time consuming and costly
- \* All areas of the firm may not be brought under the coverage of ZBB.

**14.6.2. Budgetary Control :**

It is the most popular cost controlling tool in the hands of cost and management Accountants. This seeks to control costs through the use of budgets. Budgets may be for costs and revenues. Actual costs and revenues are compared to budgeted costs and revenues and the variances are obtained. By understanding these variances, the working of the organisation is evaluated.



**Aims :**

- \* To guide the action to agree with budgeted action.
- \* to co-ordinate different activities.
- \* to motivate people.
- \* to provide basis for performance appraisal.
- \* to operate departments efficiently and effectively.
- \* to eliminate wastages.
- \* to centralise controlling.
- \* to fix up responsibility on persons etc.,
- \* to make necessary remedial measures.

**Types of Budgets :**

Functional Budgets and master Budget.

Fixed Budgets and Flexible Budgets.

Long Term and short term budgets etc.

The commonly used functional budgets include : Sales budget, production budget, Administration, cost budget, R & D budget, cash budget etc. and Master budget is an aggregate picture of all functional budgets. From the point of view of controlling business operations, fixed budgets are of no value and variable (or) flexible budgets are very much helpful. Hence, managers can think of depending upon flexible Budgets, for the purposes of controlling.

**Merits :**

- \* Maximisation of profit.
- \* Co-ordination is possible.
- \* Tool for measuring efficiency (or) inefficiency.
- \* Elimination of weakness is attempted.
- \* Reduced and controlled costs.
- \* Remedial actions are made.

**Limitations :**

- \* Uncertain Future
- \* Revisions Required

- \* Problem of co-operation and co-ordination
- \* Resistance to change etc.,

### **14.6.3. Performance Budgeting**

It is a variant of Budgetary control. It is a budgeting system in which input costs are related to the end results. It is a system of budgeting which provides for appraisal of performance as well as follow up measures.

Under conventional budgeting, emphasis is laid on the expenses to be incurred. On the other hand, in performance budgeting, end results are emphasised upon (or) the performance as such is stressed.

#### **What does it involve ?**

There are several things involved in performance budgeting. They are as under :

- \* Development of performance criteria
- \* Measurement of performance of each programme
- \* Matching the budgeted performance with the real/actual performance.
- \* Periodical reviewing to take up remedial measures.

Thus, performance budgeting primarily aims at controlling performance or results but not costs. To the management, it is a good device.

### **14.6.4. Responsibility Accounting [R.A.]**

This is another managerial cost controlling device of recent origin. Responsibility accounting seeks to lay emphasis on individual performance aspects for control purposes while the other traditional accounting devices like Budgetary control lay emphasis on total cost of production. This is basically associated with again budgetary control and standard costing tools.

#### **Definition by ICWAI:**

“It is a system of Management Accounting under which accountability is established according to responsibility delegated to various levels of management and a Management information system instituted to give a adequate feedback interms of delegated responsibility. Under this system, divisions (or) units of an organisation under a specified authority in a person are developed as responsibility centres and evaluated individually for their performance.”

According to this, the organisation is divided into different cost centres, put under different persons with adequate authority delegated to them to complete the work assigned. A good system of Management reporting is used to assess the performance of cost centres.

**Steps needed to install R.A.**

The primary goal of responsibility Accounting (R.A.) is to help the management achieve the organisational goals, of course, through controlling costs and performances. The following are steps:

- \* Organisation is divided into responsibility centres kept under the care of different managers. In turn, it is their responsibility to account for anything that develops in their respective departments or responsibility.
- \* Targeted or goal performances for these responsibility centres are fixed up and they are adequately communicated.
- \* The actual performance of each responsibility centre is measured as per the predetermined criteria for measurement.
- \* Now, both goal performance and actual performance of the responsibility centre are matched with each other.
- \* If actual performance happens to be less than the goal performance, the people of these responsibility centres with their names as such, are communicated to the top management for taking remedial action.

In this way, R.A. seeks to control the inefficiency of the people incharge of the responsibility centres.

**14.6.5. Break Even Analysis (BEA)**

This is an important cost controlling and cost reducing device available to the managers, particularly to Cost and Management Accounting personnel, from Marginal Costing, as one of the techniques of Costing. The study of the cost-volume-profit (CVP) analysis is often referred to "break even analysis". This is possibly understood in two ways. Broadly, BEA refers to the study of relations among costs, volume, and profits for different levels of activities. Narrowly, it is locating a level of activity where and when costs are equal to revenues resulting in no profit, no loss. For details, see the figure following.

**Premises :**

- \* All costs can be segregated into their fixed and variable parts.
- \* Variable costs P.U. remain constant.
- \* Fixed costs for levels of output are constant.
- \* Selling price P.U. is unchanged
- \* It is only volume of production that can change costs etc.

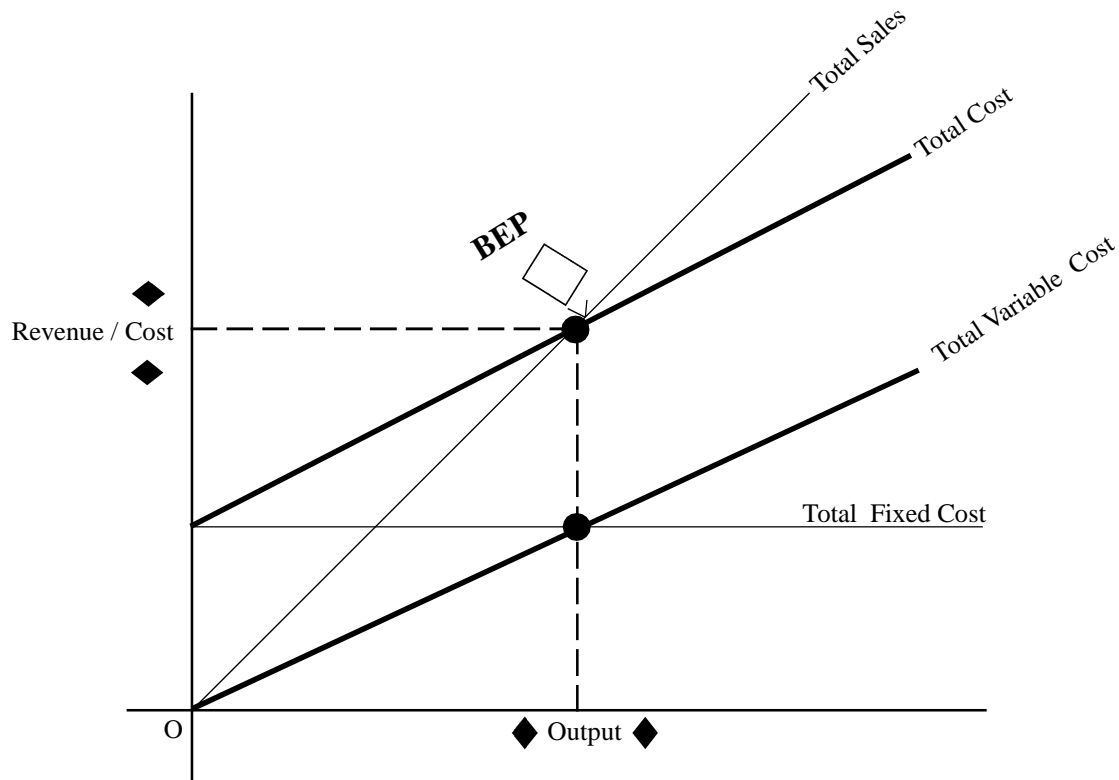

Figure14.2 : Break Even Analysis

#### Advantages :

- \* Profitability under different products/levels can be assessed.
- \* BEA is useful to make a forecast of costs and profits in future.
- \* Break even point can be known.
- \* It is used for managerial decisions making and controlling business operations.

In the above Break even Analysis chart (volume) output is measured on the X-axis while Revenue (or) cost is on the Y- axis. Fixed cost, total cost, variable cost and sales lines are drawn. Break even point is located graphically where TC and Sales lines intersect with each other.

#### 14.6.6. Human Resource Accounting (HRA) :

It is every body's knowledge that an organisation can become great and dynamic through its people that make up the organisation. Human Resources are called the most invaluable assets in the organisation. But, these human resources do not appear in any form, in writing up of accounts at the end of the year. An attempt is being made to record the human side of the organisation. This HRA is one of the several moves in this direction.

HRA is one method which endeavours to measure both, the cost and value of people to an organisation.

### **American Association of Accountants :**

HRA is a process of identifying and measuring data about human resources and communicating this information to interested parties.

Eric Flam Holtz : “It is accounting for people as an organisational resource. It involves measuring the costs incurred by firm to recruit, select, train, and develop human assets. It also measures the economic value of human beings to the organisation. Thus, it is the measurement of costs and values of people for the organisation.

### **Objectives : HRA seeks to meet the following:**

- \* to recognise the cost and value of human resources.
- \* to improve upon the human resources.
- \* to improve the quantity and quality of goods and services thereby.
- \* to facilitate the effective and efficient management of human resources etc.

### **Approaches/methods used in HRA :**

- \* Historical Cost Approach
- \* Replacement cost Approach
- \* Opportunity Cost Method
- \* Flamholtz’s Stochastic Rewards Method
- \* Lev and Schwartz’s present value of future Earnings Model.
- \* Brummet, Flamholtz, Pyle’s Economic Value Model
- \* Morse’s Net Benefit Model etc.

### **N.B. Some important methods are briefly explained:**

#### **\* Historical Cost Approach :**

In this method, historical costs are the costs incurred on human resources on various items of expenses viz., Planning, recruitment, selection, placement, training, development etc. These costs are computed, capitalised and amortised over the useful life of the human assets concerned. If this asset is liquidated prematurely, losses will be changed to Profit and Loss A/c and if the case is otherwise, revisions are made in the amortisation schedules.

#### **\* Replacement cost method:**

Replacement costs are the costs that would be incurred, if the existing people employed are to be freshly employed. Based on these replacement costs, the cost and value of Human Resources are ascertained. Here,



again costs mean the costs that are incurred on several personnel areas like: recruitment, selection, training / development etc.

**\* Stochastic Rewards Model :**

- \* In this, set of roles that persons play in the organisation is decided in the first place.
- \* Determination of the value of each role of the person to the organisations is to be made.
- \* Estimate the probable period for which the person is likely to play a role.
- \* Accordingly, a person's value is dependent upon the roles that a person plays, in the effective life span of a person in an organisation.

**\* Lev and Schwartz's P.V. Method :**

- \* This method seeks to divide the employees into homogenous groups.
- \* Estimation of the future earnings of these groups is made.
- \* Present values of the above future earnings are calculated.
- \* So, these PVs. are the values of people in groups.

**\* Brummet, Flamholtz, Pyle's Model:**

- \* In this method, firm's future earnings are estimated and the PVs thereof are also calculated.
- \* In this total of present values, a portion is allocated to human resources implying that it is due to the contribution made by the people.
- \* Thus, the allocated part in the total, constitutes the value of Human Resources.

**14.6.7 Programme Evaluation and Review Technique (PERT) and Critical Path Method (CPM):**

PERT and CPM are the two most famous catch phrases in the management parlance when we talk about planning and controlling. PERT is said to have been brought into news as a mathematical and schematic network technique by Boos, Allen, and Hemilton, in 1958, under the sponsorship of U.S. Navy for use in Polaris submarine project. More or less, at the same time, C.P.M. (critical Path method) was also brought by a group of employees of Dupont and univer divison of Sperry Rand. Originally, these two tools were developed for planning and controlling aspects of large, complicated defense projects/contracts Now-a-day, these are being increasingly employed for the introduction of new products, book publishing activities, house constructions, constructions of theatres and super markets computer installations etc. These two tools are proving to be very much useful in all these diversified activities, as they unearth the trouble spots, and bottle necks, to take some remedical and corrective actions.

PERT is a time - event network analysis system in which, various events in a Programme (or) a project are identified, with a planned time established for each. These events are placed in a network showing the relationships of each event to the other events.

CPM is one which shows the sequence of events and activities within a programme Evaluation and Preview Technique network that takes the longest period of time to complete.

The following figure about a major assembly of an Air Plane shows a PERT flow chart which makes us understand the concept clearly. PERT network is full of circles (O), arrows, activity time etc. where they have got their own respective meanings.

Circles (O) : An event is represented by a circle. It is also a supportive plan whose completing can be measured at a point of time. These circles are numbered as per the time of occurrence of the events.

**\* Arrow ( ◆ ) :**

- \* Each arrow represents an activity
- \* It also indicates the time consuming element of a programme
- \* It indicates the effort that must be put between events.

**\* Activity time :**

- \* It is indicated by a number just by the side of an arrow in the newtwork
- \* It is elapsed time required to accomplish an event.

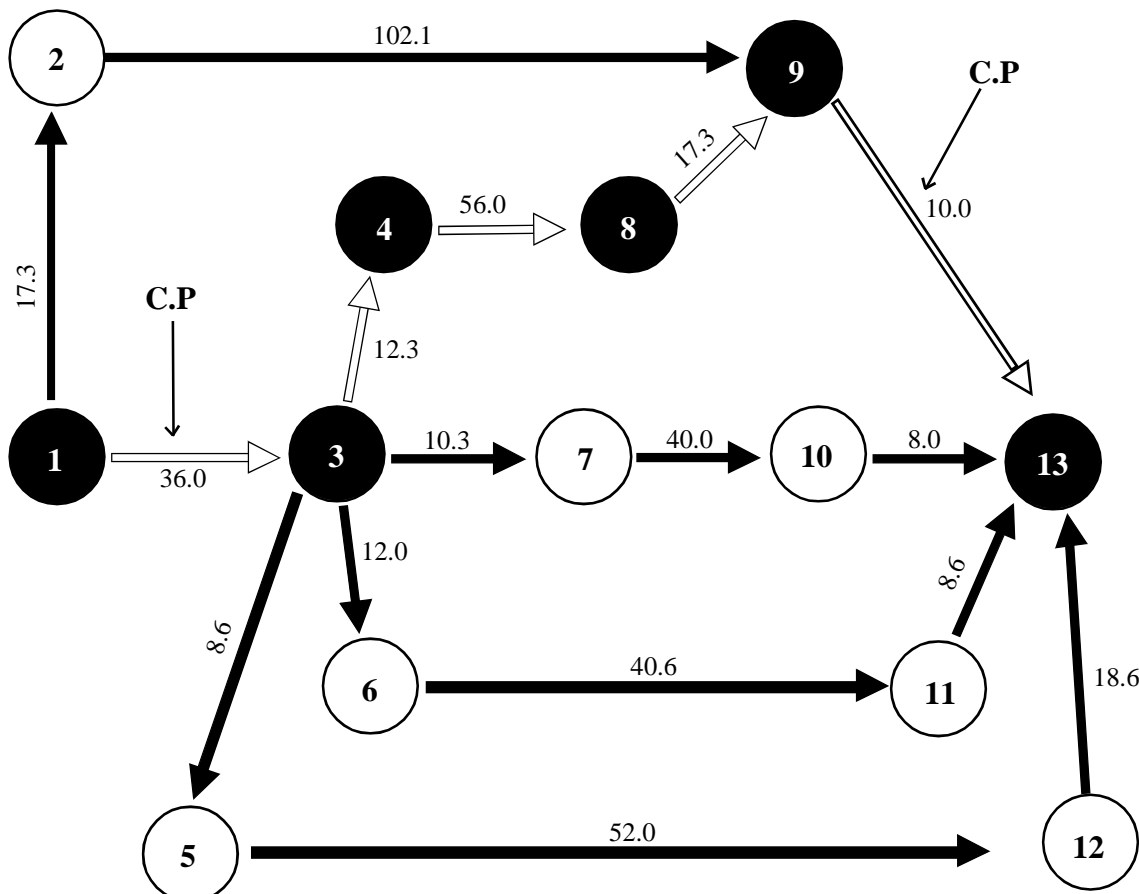

Figure 14.3 : PERT Flow Chart : Time in weeks

Source : Harold Koontz and Heinz Weihaarich. Management, Tata Mc Gral Hill P.426

### \*Example used in PERT and CPM

This given example is about assembly of an air plane. Events necessary are :

1. order programme : go-ahead
2. initiate Engine procurement
3. complete plans or specifications
4. complete Fuselage drawings
5. Submit GFAE requirements
6. Award Tail Assembly Sub-contract
7. Award Wing sub contract
8. Complete manufacture of Fuselage
9. Complete assembly of Fuselage engine
10. Receive wings from sub-contractors
11. Receive tail assembly from sub-contractors
12. Receive GFAE
13. Complete Air Craft

### NB : GFAE stands for :

Government Furnished Air plane Equipment

If a PERT flow chart is drawn with this example, the figure looks like the one shown in the above section.

Normally in this PERT model, certain time estimates are used. But in this example, only one time estimate is used. Time estimates like: Optimistic time, most likely time and Pessimistic time are the three time estimates used and time estimated for different events of the projects or programmes is calculated as per a formula shown below with some weights given.

$$te = \frac{O + 4m + P}{6} \quad \text{where, } te = \text{time estimated}$$

O = Optimistic time,                      m = mostly likely time

P = Pessimistic time.

\* Koontz and wehrich ibid.

**A small example illustrates it best :**

Find out  $t_e$  (time estimated) when  $O = 2$ ,  $m = 6$ ,  $P = 10$  weeks, for an event called : 1 - 2

$$t_e = \frac{O}{6} + 4 \frac{m}{6} + \frac{P}{6} = \frac{2}{6} + 4 \times \frac{6}{6} + \frac{10}{6} = \frac{2}{6} + \frac{24}{6} + \frac{10}{6} = 6 \text{ weeks}$$

i.e. time estimated for “1 - 2” event is 6 weeks

The next job is to calculate critical path. CP is the longest path in terms of events and time. CP is the sequence of events which takes the longest time and which has zero slack time (or) the least time. In the above given PERT flow Chart, 1 - 3 - 4 - 8 - 9 - 13 is the critical path as time in weeks is as long as 131.6 weeks. If promised delivery time is taken as 135 weeks, and CP is 131.6 weeks, the completion of the air craft would be over earlier than the time promised, by as many weeks as 3.4.

In these PERT flow charts, several paths sometimes appear to be CPs which is no unusual scene. But, the most critical one is to be identified as the critical path which requires a lot of care, experience, acquaintance with the work in progress, technical knowledge etc.

**14.6.8. Total Quality Management (TQM)**

This is the most recent concept being over heard. Companies like: Maruthi, Bata, Phillips etc. are talking very much about TQM through their ad. campaigns what is TQM at all? Definitely, it is not what is known to us conventionally about quality concept. It is really something new and novel.

- \* It means doing things right in the 1st attempt itself.
- \* It is not doing something in the 1st place and then correcting it.
- \* It is almost equal to development of a separate organisational culture committed to quality, quality and quality.

**Main Philosophy :**

This TQM revolves in and around four (4) important aspects. They are :

- \* Do it right in the first instance itself.
- \* Be clientele oriented.
- \* Make “Continuous improvement” a way of life.
- \* Build team work and empowerment.

### TQM Tools/Techniques (Briefly explained)

- \* Bench marking
- \* Quality circles
- \* Empowerment
- \* Out sourcing
- \* Reduced cycle time etc.

**Bench Marking** : It is the continuous process of comparing an organisation's strategies, products, processes, etc. with those of the best organisations in the environment.

**Quality Circles** : It is a formal or informal arrangement of some six to twelve people to meet regularly to discuss the problems pertinent with quality aspects in their organisation and to findout a way-out for the same. Japan is very famous for Qcs.

**Empowerment** : It is the authority to take decisions within one's area of operation without having to get any body's further approval. This is in other words giving one, sufficient amount of authority and responsibility and autonomy.

**Outsourcing** : It is something like considering "Buying from outside agency being specialised in a component making" as better alternative than "making that component in our own organisation when we are not very much specialised and good at that.

**Reduced cycle time**: By following time study and motion study of scientific management of F.W. Taylor, understanding clearly the concepts like: Grantt's charts, Milestone Budgeting PERT and CPM, Just-in-time etc, the firm can think of reducing the cycle time. Thus, several modern techniques are within the reach of Management for the managerial control.

**14.7. Summary** : In the absence of controlling, management is nothing. Management must result in effeciency and effectiveness. One is able to understand all these things that management is efficient (or) inefficient only when controlling is there. So, it is a Sine-Quo-non in management. Planning and controlling are two inseparable functions. Comparision of actual performance with standard performance is the main crux of controlling. Controlling is reviewing, auditing, verifying whether things are proceeding in agreement with contemplated way. It is taking a remedial acton, if any adverse a gap between Standard performance and actual performane is noticed.



### 14.8. Key words :

1. **Controlling** : Controlling is the process of comparing actual performance with standard performance to find out the degree of variance, find out causative factors, analyse them into controllable and un-controllables and then to control the controllables.
2. **Zero Based Budgeting** : Zero based budgeting is a budget prepared with Zero (0) as the base. No base is the base for this budget preparation.
3. **Performance Budgeting** : Performance budgeting is a variant of budgetary control. It is a budgeting system in which input costs are related to the end results. It is a system of budgeting which provides for appraisal of performance as well as follow-up measures.
4. **Responsibility Accounting** : Responsibility Accounting is a system of Management Accounting under which accountability is established according to responsibility delegated to various levels of management and a management information system instituted to give an adequate feedback in terms of delegated responsibility. Under this system, divisions or units of an organisation under a specified authority in a person are developed as responsibility centres and evaluated individually for their performance.
5. **Break-Even Analysis** : Break Even Analysis refers to the study of relations among costs, volume, and profits for different levels of activities. Narrowly, it is locating a level of activity where and when costs are equal to revenues resulting in no profit, no loss.
6. **Human Resource Accounting** : Human Resource Accounting is one method which endeavours to measure both the cost and value of people to an organisation.
7. **Programme Evaluation and Review Technique** : Programme Evaluation and Review Technique is a time-event network analysis system in which, various events in a Programme or a project are identified, with a planned time established for each. These events are placed in a network showing the relationships of each event to the other events.
8. **Critical Path Method** : Critical Path Method is one which shows the sequence of events and activities within a Programme Evaluation and Review Technique network that takes the longest period of time to complete.
9. **Total Quality Management** : Total Quality Management means doing things right in the 1st attempt itself. It is not doing something in the 1st place and then correcting it. It is also equal to development of a separate organisational culture committed to quality, quality and quality.

### 14.9. Self Assessment Questions :

1. Explain the process and steps in controlling.
2. What factors make controlling effective?
3. As a modern manager, what new techniques do you want to employ for controlling?

### 14.10. Further Readings :

- \* Harold Koontz, Management
- \* James A Stoner, (et) al, Management
- \* LM. Prasad, Management
- \* VSP Rao and Hari Krishna, Management

**Dr. G. Satyannarayana**

## Lesson: 15

# INDIAN MANAGEMENT SCENARIO

### Objectives:

This lesson seeks to help you learn:

- \* Indian Management
- \* How is Indian Management
- \* Professional Management
- \* Management Development
- \* Need For Management Development
- \* Methods of Management Development

### Structure:

- 15.1 : Introduction
- 15.2 : How is Indian Management ?
- 15.3 : Professionally Managed Scenario
- 15.4 : Professional Management : A wild Goose chase
- 15.5 : Tasks of a Professional Manager
- 15.6 : Professional skills of top Executives
- 15.7 : Management Development And Succession Planning
- 15.8 : What is Management Development
- 15.9 : Who is Manager?
- 15.10 : What is Manager Task?
- 15.11 : Basics of Management Development
- 15.12 : Why Management Development ?
- 15.13 : Objectives of Management Development
- 15.14 : Management Development And Levels of Management.
- 15.15 : Management Development And Management Functions
- 15.16 : Management Skills And Management Development
- 15.17 : Management Development And Managerial poles ?
- 15.18 : Management Development Impeded.
- 15.19 : Management Development Ideas
- 15.20 : Management Development And Organisational Climate
- 15.21 : Important Management Development Methods
- 15.22 : Summary
- 15.23 : Key words
- 15.24 : Self Assessment Questions
- 15.25 : Further Readings

**15.1 Introduction:** To a naked eye, Indian Management scene appears to be complex and confusing. To some extent, it can be called, professional management and it can be also called 'traditional management' to a larger extent. Somehow, a great deal of research is sought to be conducted to confirm it. If an attempt is made to find out an answer whether it is professional one, it is understood that it is professional management as Indian Management does live up to some certain tests necessary to call management, a professional management. What are these criteria? Management can be called professional management when there is formal education in management, when there is establishment of Management Associations, when ownership and management are from each other, and when there is a code of conduct to be followed by management; Indian Management to a large extent has all these features and hence, without hesitation, Indian Management can be called professional Management.

But, on the other hand, if a close observation is made, it is understood that Indian Management is characterised by "family management" and "traditional values". This side of the coin makes one call Indian Management, non-professional Management.

### 15.2 How is Indian Management ?

The following are the leading points.

- (i) Ownership and control of the business organisations are in the hands of family members.
- (ii) In these organisations, the objective mostly happens to be the maximisation of profit.
- (iii) Most of the positions in the organisational structure are filled up with members of the same family.
- (iv) Besides this, the claim of several business organisations that their management is professional management based on the isolated fact that there are some people with some professional degrees among the recruits, also is very much untrue.

In the case of large public sector also, the position is no better than this. Normally, it is understood that all large sized public sector organisation are all being run on professional lines, as we sometimes conclude based on some advertisements and publicity. Many top level public sector managers have imbibed the 100% Government way of working, proving to be a big hurdle to the initiative, creative visualisation, innovativeness etc. of these public sector managerial personnel. In this scenario, it is very much hard to expect professional management.

- (v) In the giant sized private sector organisations also, the absence of professional management appears. Reason often advanced is that business is a matter of luck and commonsense.
- (vi) Most of the organisations in the private sector appear to be mere "one man shows" only though they tell the external environment that there is a full fledged Board of Directors Constituted. All these boards are only a big eye-wash and false devices to make people believe.
- (vii) Till the recent past, our public sector organisations have been adopting the practice of taking IAS and IPS people as M.D.s and C.E.O.s These people from Civil services have a perspective and orientation different from that of business. They do not suit to business administration. Thus, they also could'nt supply good professional management.
- (viii) In the Indian industry, somehow, there is much objection to accept that managing an industrial organisation is a seperate job requiring a seperate educational qualification. This line of thinking also has promoted to perpetuate un-professional management.

Thus, owing to the above factors, traditional and un-professional management has been able to rule the Indian Management Scenario.



### 15.3 Professionally Managed Scenario:

The other side of Indian Management scene is professionally managed one. Gradually, the number of organisations is increasing. To quote a few, the following ones may be thought of.

ONGC, IOC, TELCO, TISCO, ITC limited BHEL etc. There is no hesitation to accept that the managerial personnel of these organisations both in public and private sectors stand ample of chances of being compared with those of their counterparts in western Countries.

The following points may be considered in support of this proposition.

- (i) In the recent times, Indian industry is getting influenced by the MNCs through their subsidiaries and associated operating in India. These offspring of MNCs in India are very much fast in introducing modern concepts in management. Since these organisations in India have met with success in terms of growth and profitability, it can be said that it is all owing to professional management concepts introduced.
- (ii) In the earliest days of public sector in India, only nonprofessionals are stated to have been inducted into the organisations, as the then top managerial personnel. Somehow, with these personnel, public sector could not have registered the desired growth and development. The government then took a new decision of inducting professional managers into the public sector. Since then, public sector started growing on sound and professional lines. This new decision of the Government paved the way for professional management.
- (iii) On knowing the managerial needs of Indian industry, and appreciating the idea that fully trained and developed managers only could help the country have industrial development taking place at the desired place, several formal institutional arrangements, agencies and organisations have started appearing in the Indian scene, to bridge up this yawning gap between supply of and demand for the professional managers. By this, need for formal "Management Education" has increased in response to which many Institutes of Management at places like: Ahmedabad, Calcutta, Bangalore, Lucknow etc. To impart formal management education have come into play. Now, almost all Indian Universities and Colleges have their own graduate and post-graduate programmes in Management Education. Besides the regular campus educational activity, the most recent Indian trend is that there is good rise in learning management education through Directorates of Distance Education of all Indian Universities more or less.

**Some prominent and noteworthy management educational centres are:**

- \* Administrative Staff College of India
- \* Management Development Institute
- \* National Institute of Bank Management. (NIBM)
- \* National Productivity Council (NPC)
- \* All India Management Association (AIMA)
- \* National Institute for Training in Industrial Engineering (NITIE) etc.



Besides the above, several public sector and private sector organisations have launched their own Management development centres. They are: SAIL, LIC, most of the commercial banks, TELCO, HLL, ITC, TISCO etc.

Thus, Indian management scenario is marching towards professional Management from traditional and Un-professional lines.

#### 15.4 PROFESSIONAL MANAGEMENT: A Wild Goose Chase:

It will be very much surprising to note that the very discussion on the concept - professional management is very much complex and confusing, as the basis for discussion appears to be very much slippery. If some researchers on this issue are heard, it will be learnt that there are no any words or concepts like-Professional Management and professional managers. What is it then? It is said that management is a discipline. The practitioners of this discipline - management, are called as professional managers. Similarly, doctors practise medicine, lawyers practise law and managers practise management. This is nothing more than this. Worth noting difference/is that there is formal degree/education the case of "doctors or lawyers" and there is no anything as such in "management". The other important noticeable issue is that the primary concern of professional manager is the organisation with which he associates himself. He is completely drowned in the concept of organisation and it is all to him. Besides this, this so called professional manager shoulders responsibility for his performance. In this way, one is helped to identify a professional manager from others in the organisation. As a blow on the witlow, another idea is also often floated. It is said that Management is not a profession as it has no any prescribed educational qualification, there is no any accepted code of conduct on the part of managers/ management, there is no any strong professional association as such into which entry, based on some eligibility criteria, is denied etc., Since other disciplines like medicine law etc. do satisfy them, they are called regidly professions and management is denied the same status, as the three above stated are not very regidly true in management.

Thus, things are not found with adequate clarification. Yet, people argue that management has not yet obtained the fulfilledged status of professional management and it is in the process of gaining that desired status. Since this 'professional Management' concept is very loose and intangible, it is apt to say that going in search of Professional management is like making a search for a wild goose which is not to be ever traced out. For the present purpose we equate this to the most effective and efficient management which leads the organisation to the most successful achievement of organisational goals.

#### 15.5 Tasks of a Professional Manager:

- (i) Facing the challenge of increasing competition.
- (ii) Managing survivial and Growth.
- (iii) Leading for innovations.
- (iv) Keeping talent in tact.
- (v) Inculcating sense of pride and belongingness.
- (vi) Sustaining leadership effectiveness.
- (vii) Striking a balance between creativity and conformity.
- (viii) Postponing a managerial obsolenscence to a later date.
- (ix) Developing a human organisation.



- (x) Retaining firm's efficiency in terms of profits.
- (xi) Matching with increasing levels of aspirations,
- (xii) Creating, developing and maintaining cordial and harmonious Relations within the organisation.
- (xiii) Developing good organisational climate.
- (xiv) Improving morale and motivation.
- (xv) Replacing unilateral decision making systems by bilateral system.
- (xvi) Leading to promote synergy.
- (xvii) Encouraging the implementation of new management concepts like: MBWA, TQM, QWL etc.
- (xviii) Maintaining good relations with different segments of society.
- (xix) Institution building as an important task etc.

### 15.6 Professional Skills of Top Executives:

The most noteworthy functions of the top person of the organisation is that he should build an organisation for which he should be endowed with some special skills.

There are 8 important skills that a professional top man shall possess

- (i) Identity creating role.
- (ii) Enabling role.
- (iii) Synergising role.
- (iv) Balancing role.
- (v) Linkage building role.
- (vi) Futuristic role
- (vii) Making/leaving impact
- (viii) Providing super ordination to the lower levels.

Should there be professional management, should these professional managers perform these contemplated professional tasks successfully, and should then play the above said roles effectively, managers need development and training and thus, the preceding discussion leads us to Management Development. So, management development is a since-Quo-non.

### 15.7 MANAGEMENT DEVELOPMENT AND SUCCESSION PLANNING:

Normally, career mounting and succesison planning are considered interchangeable. There is very insignificant difference. For higher level executive, we use the word "Succession Planning". While, career planning is used when want to refer to executives at all levels including highly skilled employees and operatives. Requirements and implication of Management Development for both career planning and succession planning are very much similar. Management Development must be in accordance with carer planning and in particular, succession planning. Succession planning is an activity to identify the vacancies that are likely to fall vacant in the near future and developing the existing eligible candidates towards those future vacancies, through these Management, Development Programmes. The following illustrations will describe it best.

**ILLUSTRATION - 15.1****SUCCESSION PLAN IN STANDARD IN STEEL LIMITED, BHILAI, FOR MANAGING DIRECTOR**

(Due to retire at 60 years, a year hence)

S.No.	Name	Present	Position	Age	Colour code
1	Mr.M	Production	Dir.	56	Blue
2	Mr.N	Marketing	Dir.	53	Red
3	Mr.O	Planning	Dir.	54	Green
4.	Mr.P	Personnel	Dir.	51	white
5.	Mr.Q	Finance	Dir.	55	white

**ILLUSTRATION-15.2****SUCCESSION PLAN FOR GENERAL MANAGER (PERSONNEL) (RETIRING AFTER 2 YEARS)**

S.No.	Name	Present Position	Age	colour code
1	Mr.Stevens	Personnel Manager	54	Red
2	Mr. Sunil	chief I.R.O.	58	Blue
3.	Mr. Shan	Development Officer	52	Green

**colour code:** Green: ready now; Blue & Red: in 3 to 5 yrs white : Not likely to be qualified

In illustration (1), Mr. O is the right choice and Mr. Khan in Illustration (2) is the obvious choice. As so this These people need to be developed as per some suitable Management Development Method in order, that they may take up their new positions efficiently and effectively.

**15.8 What is Management Development?**

It is development of managers for managing the organisation. **Dale S Beach** Defines it as: "a systematic process of training and Growth by which managerial personnel gain and supply skills, knowledge, attitudes, and insights to manage the work in their organisations effectively and efficiently".

It is a systematic process of growth and development, by which, the managers develop their abilities to manage. So, it is the result of not only participation in formal courses of instruction but also of actual Job experience. It is concerned with improving the performance of the manager by giving them opportunities for growth and development. Dale Yoder et al define Management. Development as a programme of training and planned personal development purporting to prepare and aid managers in their present and future jobs.

It is thus, a systematic effort to use principles of planning, organising, co-ordinating and controlling in the selection and development of managers as opposed to the unsystematic methods based on the assumption that "cream will come to the top".



### 15.9 Who is Manager ?

Manager is a person to mean different people at different levels of organisational hierarchy. Manager is a person who supervises others basically. These managers are not born but are made and developed.

### 15.10 What is Manager's Task?

Manager's job is management. This management is a process and this process is a process of carrying out some managerial functions viz., Planning, Organising, Staffing, Directing, Motivating, Leading, Communicating, Coordinating and Controlling. It is a profession, an art and a science. Managers' job is somewhat conceptual, Philosophical and educative. It is concerned with knowing about human skills which tell about Social and behavioural aspects of people. This job is also related to attitudes and modification of behavioural aspects: Managers job is not much related to technical aspects. It is more about management functions and decision making, in particular. Thus, the above stated elements will form the core of manager's job/task.

### 15.11 Basics for Management Development

Following are the basics needed for the Management Development.

- (a) Knowledge of present and future organisational needs.
- (b) Knowledge of inventory of present management talents, skills, competencies, behavioural aspects etc.
- (c) Planning for individual development programmes.
- (d) Establishment of Development programmes.
- (e) Evaluation of the programme.

#### (a) Present and future organisational Needs:

Importantly, the following need be considered.

- (i) Critical assessment of present and future needs.
- (ii) Quantifying the number of managers to man.
- (iii) Accordingly, qualifying the managers.
- (iv) Job analysis preparation
- (v) Preparation of Job description and job specifications.
- (vi) This is all man power planning once again for managers.

#### (b) Present Inventory of talents:

Existing level of talents, skills, competencies, knowledge etc. of the present people in the organisation is to be understood to identify the gaps to be bridged up with management. development.

**(c) Development of individual development programmes:**

Based on the above steps and gaps identified, an individual development programme needs to be tailored. We have to remember that we have to cut the coat according to the cloth. Since 'gaps' differ from person to person, this individual development programme is to be launched.

**(d) Establishment of Management. Development Programmes:**

According to the needs of the trainee-managers, method like: Leadership courses, Management. Games, Sensitivity training programmes, Case studies, Conferences etc. are developed.

**(e) Programme Evaluation:**

This is the last step in any programme. It is the obligation of the training and developing agency to verify whether the methods developed have resulted in any expected benefits to the managers or not. It is making an audit and review. Feedback is obtained and based on this, if need is there, revisions and corrections are made and then, we proceed again towards developing the management. Trainees.

**Methods of Management Development : (discussed in next section)****On the Job Techniques:**

coaching,  
Job Rotation,  
Under Study,  
Multiple Management etc.,

**Off The Job Techniquities:**

Case Method,  
Incident Method  
Role Playing,  
In Basket,  
Business Games,  
Sensitivity Training.  
Simulation,  
Conferences,  
Lectures, etc.,

**15.12 Why is Management Development Required?**

For the growth and development of an organisation, Management Development is a sine-Quo-non. Organisation has to identify the potential for development at different levels. Managers to be developed may be the existing ones, fresh recruits from management institutions and managers that have potential. This development of managers is traced out due to the following factors.

- (i) Labour-Management relations are becoming more and more complex.
- (ii) Managers are obliged to give a better handling to the problems of industrial organisations due to enormous size and complexity associated with it.
- (iii) Recognition and awareness of social and public responsibilities on the part of managers are increasing. This in return is compelling the modern industrial organisations to make their managers more learned, knowledgeable and developed.



- (iv) Industrial society now-a-days, is under going a rapid technological and social change. Change is becoming the order of the day. Every organ of the external Environment is changing. There is change in automation, markets, climate, competition, labour etc. Hence, this all round change invites and welcomes a change in the out-look of the managers. Thus, managers need a special orientation.

### 15.13 Objectives of Management Development:

The following are purposes of management development.

- (i) To overhaul the management machinery.
- (ii) To improve the performance.
- (iii) To improve thinking process.
- (iv) To improve analytical and problem solving skills.
- (v) To improve conceptual and human relations skills.
- (vi) To make managers good planners and organisers.
- (vii) To make managers good directors.
- (viii) To improving motivating skills.
- (ix) To help manager encourage creativity of the subordinates.
- (x) To help manager encourage creativity of the subordinates.
- (xi) To improve communication skills.
- (xii) To help managers gain good insight in some modern management concepts viz., MBO, MBE, MBWA, TQM, QC, QWL etc.
- (xiii) To improve the versatility of managers.
- (xiv) To help the organisation have a second line of defence
- (xv) To post-pone managerial obsolescence.
- (xvi) To assure the corporate body, of the availability of required number of managers with required skills to man the present and future needs of the organisation.
- (xvii) To encourage other managers to grow as developed and professional managers.
- (xviii) To sustain good performance of managers throughout their careers.
- (xix) To make the organisation a dynamic one as it is only people that can make the organisation a dynamic organisation.

### 15.14 Management Development and Management Levels:

Needs of managers differ from level to level. Top managers requirements are at variance with that of middle level and lower level. Hence, it is imperative to know about different jobs that managers at different levels do. Accordingly their management development should be.





**15.16 Management Skills and Management Development :**

The agency that conducts Management. Development programmes for managers has to know about relative importance of managerial skills. Robert L. Katz is of the opinion that managerial skills importantly are; Technical, Human, conceptual and problem solving. The following Figure tells that, for “human skills” are the most important skills that need to be injected through Management. Development programmes: This is illustrated best by the following figure.

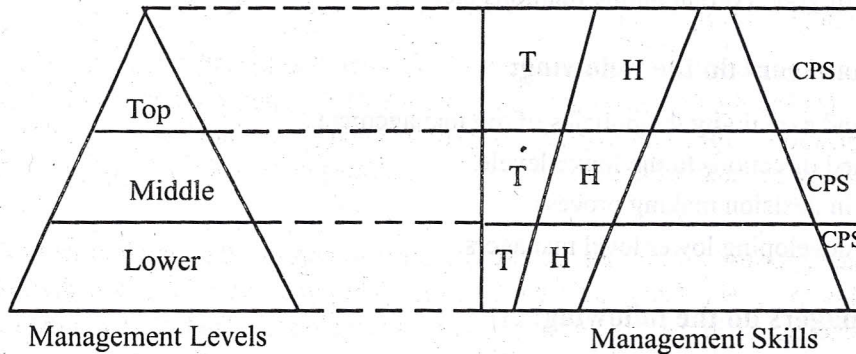

T = Technical, H = Human, C.P.S. = Conceptual Problem Solving

Figure15.2 : Importance of managerial Sills

**15.17 Management Development and Managerial Poles:**

Henry Mintz Berg has said that managerial poles possibly are 10 (ten) in number. They are; interpersonal, informational and decisional roles. The following table gives an idea about roles;

Management development programmes should match with the roles that managers have to play. Should they play these roles well, they need to be specially educated and trained. Hence, much relation is there between Management. Development and Managerial roles.

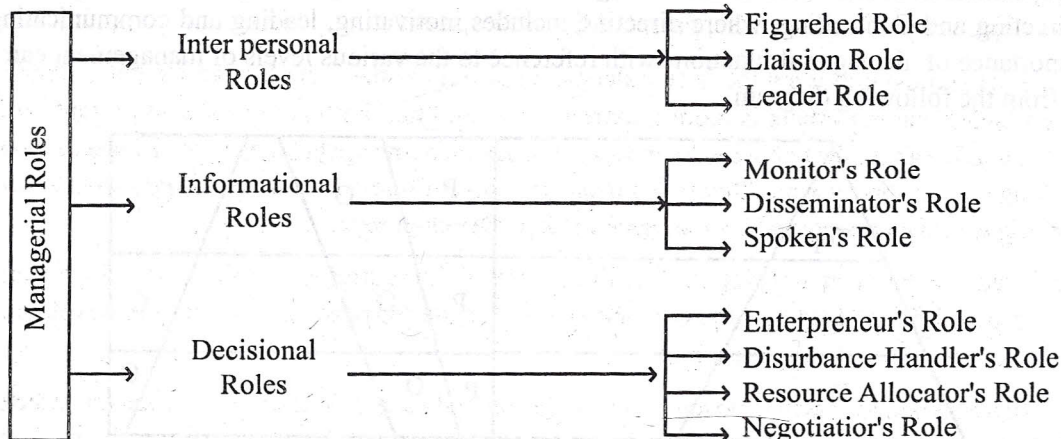

Figure 15.3 : Management Development and Management Levels

**15.18 Management Development impeded:**

The factors to impede management development are many and several.

- (a) Job security, stability, pensionary benefits etc. slow down the mobility of employees and arrest the recruitment of younger people.



- (b) Supervisors especially at the middle level often feel bred, disgusted and discouraged. They have little hope that they would get promotional opportunities. This is mostly the case of a person not having ego orientations and of a person having no sense of pride with the organisation and sense of belongingness.
- (c) Factors like home ownership, home sickness, close ties with communities, social activities etc., being accompanied by no job security may also impede mgt. Development.
- (d) Sometimes, bad and un congenial and uncordial relations between superiors and subordinates also may slow down mgt. Development.
- (e) The organisational climate, health and atmosphere are such that the subordinates are always afraid of their superiors. Definitely, for learning "management", a free, open and harmonious climate is essential in the organisation. Mgt. Development is no more and no less than learning professional management from supervisor managers and trainers. So, this atmosphere is not conducive for mgt. Development.
- (f) Some times, the superiors find little time and incentive to care for the development of subordinates. This may be due to several fears and lame excuses. They may be of the idea that the subordinate manager may excellence in performance, if he is fully developed. That is why, most managers don't delegate.

Thus, the above factors may slow down mgt. Development to some extent.

### 15.19 Management Development Ideas :

Mgt. Development was traced out to the following ideas in the past.

- (i) Mgt. Development is not ad-hoc. It is not terminal. It is perennial activity. It is eternal and extended life-long learning.
- (ii) The basic premise is that there is always a gap between standard performance of the manager and the actual performance. The real case is always that the actual performance falls short of standard / targeted / objective performance. So, potential for development is very high.
- (iii) Manager's the most important job is to understand himself / in the first place and to understand others. Though understanding others is more important, it is said that both are equally important, one must have knowledge about the behavioural and social sciences, human psychology etc. He needs thorough knowledge about theory X and theory Y no assumptions of human behaviour, developed by Douglas MC Gregor. This knowledge is all subject of Mgt. Development.
- (iv) In a relaxed environment, development can't take place. It requires an environment where people are much prepared for undergoing stresses and strains for the purposes of growth and development of themselves and them, the organisation.
- (v) The most important idea is that development at the desired pace is possible only when the targets to be met are clearly laid down and the methods and modus that need to be employed to achieve the targets are clearly known to the people.
- (vi) Development is very fast only when we avoid spoon feeding. They must be accorded an opportunity to involve themselves in the organisational activities. They must be given a chance to participate and share and try once what they have learnt. It is known to all of us that it is practice that makes man perfect.



- (vii) The last but not the least is that there must be good and right feedback based upon which, plans for rectification and improvement can be thought of. Feedback helps the trainer know level of knowledge of the trainee.

Thus, there are several ideas about mgt. Development.

### **15.20 Mgt. Development and Organisational Climate:**

It is beyond doubt that mgt. Development occurs in a particular organisational climate only. So, it is good if we know briefly about what is that organisational climate. This means the circumstances and the conditions that prevail in an organisation. Particularly, it is with regard to: the manner of treating people by the top mgt., style of managing and leading, level of delegation of authority, system of encouraging ideas and suggestions of the lower level people, degree of appreciation of the initiative, enterprise, creativity etc. of subordinates, tools and techniques for projection of a company's goals, policies and philosophy. This is not an exhaustive explanation.

Mgt. Development requires a favourable climate to take place at the desired scale. Most of the above referred things must be at their highest ebb. This is desired for mgt. Development. There must be definite, comprehensive and co-ordinated plan for the development of managers. It is to be prepared with peoples involvement with awareness to all that have to train and that have to be trained and developed. Since the initiative has to come from the top, the programme of mgt. Development must also start from top. So that, they may at that level, set an example.

### **15.21. IMPORTANT MANAGEMENT DEVELOPMENT METHODS:**

#### **(a) MANAGEMENT GAMES:**

A variety of computer and non-computer management or business games have been devised and used with varying success in development programmes. A management game is a classroom exercise in which teams of students compete against each other to achieve common objectives. The game is designed to be a close representation of real-life conditions. The trainees are asked to make decisions about production, cost reduction, research and development, inventories control, sales promotion etc. for a stimulated organisation. Since they are often divided into teams as competing companies, experience is obtained in team work.

Under this methods, the student learns by analysing problems by using some institution and by making trial and error type of decisions. The error of an unsound decision could be disastrous in a real business situation, But in a game an executive learns from his mistakes and has a chance to recoup his losses without harmful chance consequences. In come games, players can even get time to do something, all over again, if their first decision is wrong. A management game has objective feedback of the consequences of business decisions. Feedback is prompt and the model upon which, a game is built may be a typical to general situation, yet it may not be realistic.

Management games are used with varying success in development programmes. The game is designed to be as close representative of real life conditions as possible. Management games give experience of working in a team. The executives in this method learn because of the immediate feedback of the consequence of business decisions. This helps the individual to learn how groups actually work.



**(b) SYNDICATE METHOD:**

Training and development of executives who are already in positions of responsibility and are marked out for assuming a place at the top or near the top of business or public services has to provide for suitable opportunities such as:

- (a) Critical reflection on their own work and the manner of doing it;
- (b) Updating their knowledge of new concepts and advanced techniques in the field of management;
- (c) further improving executives skills under suitable simulated conditions; and
- (d) developing better insights and sounder judgement on their part in respect of human resources.

The process of learning on the part of an experienced executive is essentially a self imposed or willingly accepted discipline of self education.

Syndicate method is used in management development programmes for executives whose age ranges between whose age ranges between 30-40 years, who have 9-12 years experience in some special area of management to be fit for taking up higher responsibilities. The participants are men of mature judgement and proven ability. they are known to the director of the programme before actually joining it.

**Mechanics of the Method**

- a) The participants are divided into groups ( syndicates ) not more than 5 or 6 in number.
- b) Each syndicate is composed of carefully selected men who, on the one hand, represent a fair cross - section of the executives cross - section of the country drawn from private sector, Public sector undertakings, civil services, defence forces, banking, insurance, etc, On the other hand, they form a sort of a management team consisting of a well balanced mixture of the different functional specialisations such as production, general management, marketing, finance, personnel, government administration, etc.
- c) The groups are given assignments which are worked out beforehand and which have to be done within the time allotted to each in advance. Uaually a report has to be submitted on a specified date and hour : there is also some built - in pressure under which, the groups have to work.
- d) Each member of the group, in turn, is appointed as the leader or Chairman of the group for the performance of one or more of the tasksso assigned. Each member of the group also takes his turn to act as secretary to the roup for a6 least one sub-division of the course. The secretary assists the chairman and among ther things, he is responsible for preparation of early drafts of the final reports.
- e) Each task is assigned to group by means of 'Brief' in production. This is a document prepared by the concerned experts on the faculty with meticulous care; it indicates the nature and scope of the subject under study and provides a list of prescribed reading and specially prepared background materials in the form of papers, exercise and cases. The Brief also prescribes the time and period during which the study has to be completed.



- f) Besides the selected reading list in brief, lectures by experts are also arranged.
- g) For most subjects, the group is required to submit a report which is circulated to other groups for comparative study and critical evaluation.
- h) The chairman of the group is required to present the views of his group on the subject assigned to him to a joint session of all the groups and justify his group's views, in case of criticism of question.

There is a tendency to call any kind of group discussion in management courses a 'syndicate' and the impression has grown that syndicates are just groups that discuss. This is not true. It is true that on the face of syndicate work, it appears as if it consists only of discussion but there is much more than the discussion. Syndicate is, in fact, a form of organisation for the performance of a specific task of management with the help of a team, much as in real life. In judging the syndicate method and its usefulness as an educational device, one must take into account the quality and characteristics of the participants as well as the course in which the syndicate method is used. The object of the course, apart from increasing the participant's knowledge of up-to-date ideas and tools of management, is to enable him to acquire proper perspective on his job relation to the activities in areas other than his own and give him concentrated practice in skills, techniques and procedure which he has to use in his day-to-day work increasingly as he moves up in the ladder of management. The syndicated method is intended to stimulate critical thinking rather than provide spoon fed information of opinions. Even highly qualified experts find it difficult to set their lectures at the appropriate level when the audience consists of men whose experience in a given area ranges from 10 to 15 years.

**Advantages:** In developing the men of long experience and practical wisdom the syndicate method has certain basic advantages over other educational methods. It is something like the idea of the 'self-managed groups'. The greatest value lies in the practice it gives the participant in communication

communicating with and in understanding and managing colleagues and in constantly compelling him to adjust and readjust himself to what he thinks his colleagues think of him. If the course is a residential one, it has again many more advantages, such as confidence, friendliness and mutual respect for others specialisation. The healthy competition automatically sets in between the different syndicates, as also between the participants in one syndicates to make a better show, and the constant pressure of group opinion as well as the expertise and advice of the friendly directing staff. All these factors compel each participant to do his best. Such a structured and carefully guided and supervised process of 'self-education' is highly conducive to the all round development of the executive.

### (c) SENSITIVITY TRAINING:

The aim of sensitivity training is to improve the trainee's skills in dealing with people. In sensitivity training the executives spend their time attending the lectures on topics such as leadership and communication. Sensitivity training has a two-fold function.

- (a) To help its members learn how groups actually work.
- (b) To give each member of the group a chance to discover how other people interpret and are affected by his own behaviour.



The activity of T-Group consists mainly of sitting around a table discussing for hours. A trainer, usually a psychologist, neither leads the discussion nor suggests what should be discussed but only guides the discussion. Trainer at the group's first meeting simply states that the idea of a T-Groups to help its members to learn about their own behaviour and to learn from other's behaviour.

As the members of a T-Group discuss what they should talk about and how their discussion should be structured, conflicts obviously arise. Members criticise freely the behaviour of each other there by giving a feedback which may be positive or negative.

T-Group or sensitivity training is an important tool of growing importance in helping managers to win the cooperation of people working with them. There is no doubt that the T-Group is one of the significant educational innovations of the century. It has been experienced that about two-thirds of the participants undergoing laboratory training have displayed changed behaviour of positive type.

Despite the rising popularity of T-Group the value of this training is vigorously disputed by some specialists in management development. Specialists are willing to concede that a trainee may learn a thing which may be helpful at time in his life but of little use to a corporate manager trying to cope up with his job.

To support their point of view, they say that there is no proof that managers who have been to laboratory, do their jobs better than before.

Even managers who have undergone sensitivity training feel that even after learning a lot in the laboratory, it is difficult to apply the learning in real business situations. When sensitivity training technique is applied to engineering managers who ate in the dark as far as area is concerned, they normally do better.

It is found that there is a fundamental conflict between the values taught at a laboratory and the values inherent in the structure of the business. 'Argysis' concedes that laboratory education is only a partial attack on the problem of organisational effectiveness. But if effectiveness is to be permanently introduced, one must also change the organisation structure managerial controls and incentive systems. The serious criticism of laboratory training is that it is of little practical use and the trainee may be hurt by the emotional feeling. So, there is no doubt that certain anxiety and stress are inevitable in T-Groups.

To sum up, in sensitivity training, a few trainees get hurt and a few remain unaffected and great majority feel that they have been changed for the better. The top management in any organisation

organisatoin must determine before introducing sensitivity training that there is an appropriate environment for this and as there is always a risk of being hurt at a laboratory, attendance should be on voluntary basis.

It is equally important that individual undergoing sinsitivity training should be thoroughly and impartially briefed and should be encouraged to give the idea if he cannot with stand any more criticism. Thus the advantage of this process of training of the behaviour of others and sensitivity of their attitude. The effectiveness of the method would be reflected by an ultimate change on the part of the participants on their job.

NB.For some more Mgt. Devt. Methods, see lesson-10



### 15.22 Summary:

Indian management is getting slowly professionalised. Till the recent past, it was very much traditional. In case of recent entry of MNCs due to liberalisation more, our Indian Mgt scenario is able to compete with their counterparts in the western countries. It has yet to go a long way to attain the status. Indian management Education is not on professional lines. There is only mushroom growth without quality aspect. It is very much essential that there must be good rapport between industry and Mgt. Then only, good Mgt. Development is possible to make available new Managers at the desired rate to help the economy grow fast.

### 15.23 Key words :

1. **Manager :** Manager is a person to mean different people at different levels of organisational hierarchy. Manager is a person who supervises others basically. These managers are not born but are made and developed.
2. **Manager's Task :** Managers' task is management. This management is a process and this process is a process of carrying out some managerial functions viz., Planning, Organising, Staffing, Directing, Motivating, Leading, Communicating, Coordinating and controlling.
3. **Management Development :** Management development is development of managers for managing the organisation.

### 15.24 Self Assessment Questions:

- 1 Why is management development slow in India? Explain critically.
- 2 Explain some Management Development Methods in a detailed manner.
- 3 Why is Management Development Required?

### 15.25 Further Readings:

- \* VSP Rao And Ravi Krishna, **Management**.
- \* L.M.Prasad, **Management**.
- \* C.B.Gupta, **Management**
- \* Garry Dessler, **Personnel Management / Human Resource Management**
- \* Subba Rao P, **Personnel Management / Human Resource Management**

**Dr. G. Satyanarayana**

**Lesson - 16****SOCIAL RESPONSIBILITIES OF BUSINESS AND  
MANAGER'S ROLE**

**Objectives :** This lesson seeks to help you learn :

- ☒ concepts on social responsibility
- ☒ ideas of some prominent people
- ☒ debate on social responsibility
- ☒ obligations of business towards different organs of society
- ☒ social responsibility in India
- ☒ business ethics

**Structure :**

- 16.1 Introduction
- 16.2 Social Responsibilities Hanging in Balance
- 16.3 Favourable Arguments
- 16.4 Un-favourable Arguments
- 16.5 Specific Social Responsibilities towards different sections of Society
- 16.6 Social Responsibilities in India
- 16.7 Business Ethics
- 16.8 Summary
- 16.9 Key Words
- 16.10 Self Assessment Questions
- 16.11 Further Readings

**16.1 Introduction**

Systems approach to Management tells that managers at all levels should think that they can't function in isolation within the confines of their traditional organisational chests, should their management be meaningful, efficient and effective at all in the present days. They have to work in collaboration with other people, departments, divisions, sections etc., and if necessary they should interact with the representatives of the other sister organisations in the neighbouring environment. This develops synergy and especially a positive synergy in the organisational setting. This leads one to conclude that the principles of mutuality and interdependence are to be considered important in the managerial aspects. Now, this interdependence is required not only in the organisation but also beyond the organisational precincts. This means that any organisation depends upon the external environment (or) society and Vice - Versa, implying that the organisation is a part (or) a subsystem of the biggest system called the external environment. So, organisation has got some obligations towards the environment and Vice-versa. Thus, social responsibility concept of business has come into the scene.

## Definitions

Social Responsibility : [Koontz]

“It is a serious consideration, by the corporate sector, of the impact of, its actions, on society.”

Social Responsiveness :[Koontz]

“It is the ability of the company to relate its operations and policies to the social environment in ways that are mutually beneficial, to the company and society as well.”

**Charity Principle :** [James A. Stoner]

“This is a principle teaching that rich people have to feel obliged to come down to help the down trodden, depressed people of the society (or) the environment.”

**Stewardship :** [Stoner]

Business and economically well to do people are all custodians, care takers, Stewards etc., holding their properties and wealth, in trust, for the benefit of the society (or) environment.

**Mrs. Indira Gandhi on Social Responsibility :**

“Investment on Social Responsibility and welfare of the masses, is a guarantee, for the long run business survival itself.”

Shri J.R.D. Tata on Social Responsibility

“In a country like India, with many more oppressed and depressed people, the obligations of business must be more than mere making a product, fixing a fair price, paying a good wage etc. Since Indian business has adequate resources and means, it should contribute in some suitable measure to the progress and well being of the society, in which, their company is located.”

Shri L.B. Sashtriji on Social Responsibility

“In our humble way, we are trying to build a welfare state on socialistic pattern. The criterion of determining the line of advance must be not profit but social gain. The benefit of development must accrue to the less privileged society. So, business must be always alive to the needs of the society.”

The above paragraphs supply a deep insight into the concept - social responsibility of business and rich society and are very much effective in telling that there is a lot of obligation on the part of business to care for society because of principles of mutuality and interdependence, as per systems concept.

The following figures also tell the same about interdependence between organisation and society/External environment.



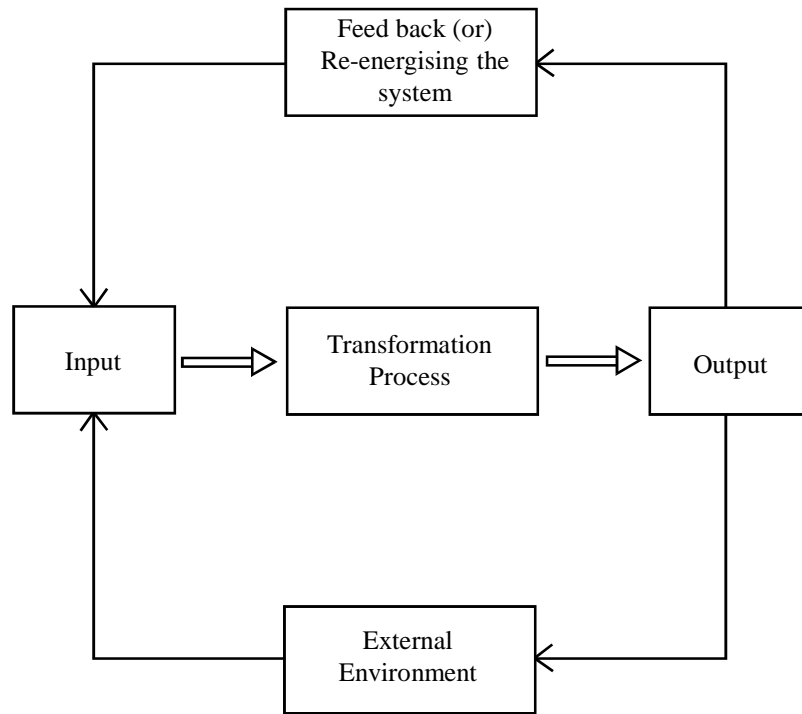

**Fig. : 16.1**  
**Systems Approach to Mgt.**

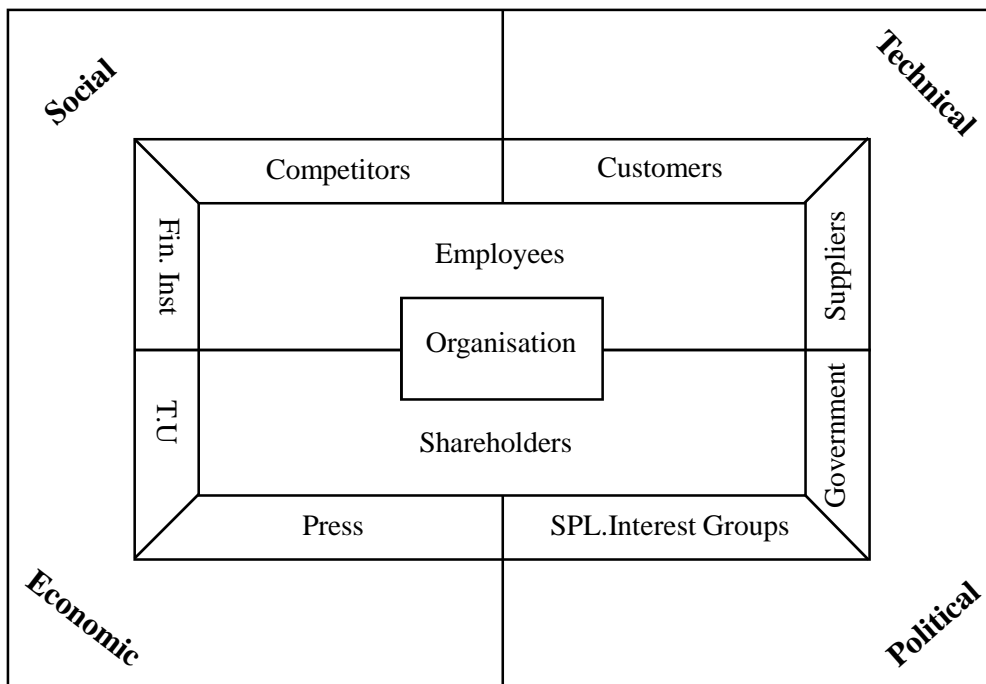

**Fig. 16.2 : (ii) Organisation And Environment**

## 16.2 Social Responsibility - Hanging in the balance :

This social responsibility concept has become a big subject of controversy and debate. Much is being said on both the sides. There are people who argue that business has to take up Social Responsibility on its shoulders while there are equally good number of arguments to say that business has no business to talk about S.R. These arguments are briefly discussed in the following sections.

### 16.3. Arguments in favour of Social Responsibility

#### a) Give and take :

Business and Society are very much related with each other. What are these points of relationships, dependence, mutuality etc? Fig (i) in this chapter will explain best that the firm depends upon external environment for mostly inputs and again, outputs. So, input is drawn from the society while, it is the society that has to find out a market for the output. Hence, business has to shoulder Social Responsibility as society/External Environment is giving a lot to the business.

#### b) Better Environment Society :

Business can do good business only when the society is good and better society, as a weak society can't give a good market. So, business, for the sake of its own business, has to think of helping the environment in the best possible ways to make it fit to give business to business.

This idea is corroborated by the idea of Mrs. Indira Gandhi, discussed in the above paragraphs.

#### c) Reduced State Interventions :

When business steps into the shoes of care taker to look after the interests of the society, Society/Environment will be good, giving no trouble to the govt. Govt. also feels a sigh of relief and appreciates the role of business towards society. Thus, Govt. somehow would reduce its concentration on business and thus; it is a big plus point to the business. It is that business is in the good looks/books of the state and it is good for the business as it can freely do its business.

#### d) Authority and Responsibility party :

This argument may look a little bit odd to hear. In management parlance, both these concepts are inseparable. It is an important pair of words. When authority is there, responsibility also should be there and that too, proportionately and **Vice-Versa**.

Here, Indian business is already big and rich and powerful and authoritative by virtue of its bigness and richness. So, the argument is that this authority or power gets adequately balanced when responsibility to care for the society also is placed in the hands of business. Hence, business should have responsibility for society also.

**e) Systems concept :**

This was already discussed adequately. This says that business has obligation to care for the environment as the environment cares for business in many and varied ways. So, business should take up Social Responsibility.

**f) Enriching Share holders :**

The above discussed second point gives food to this argument. One of the objectives of the business is to maximise the interest of the share holders. To achieve this, business wants more business. The biggest business giver is the society. Hence, if business takes care of society, society will take care of business which in return can take care of share holders.

**g) A special place for business : Problem solver :**

By specially and exclusively taking care of society or environment., business can always enjoy a special place and status. There is a niche to the business in the society. It goes to be specially remembered and recognised.

When social problems like: Prohibition, adult literacy, Anti AIDS campaign etc. are taken by Pvt., sector, it is garlanded and worshipped like anything.

**h) Prevention is better than cure :**

If business show's much interest and commitment towards society, it becomes problem-free. Thus, Society is strong enough to provide good market to corporate business. Thus, there is relief to the business and Govt. too. Hence, business should take up Social Responsibility

**16.4. Arguments not in Favour of Social Responsibility****a) Primary task :**

Since primary business of business is not this business (Social Responsibility), it is something that is to be discouraged. Hence, business must not look at it.

**b) Costly :**

Caring for the society is definitely an additional task and it is costly. Hence, it is to be discourgaed.

**c) Unfavourable to the Foreign Trade :**

We can bag foreign orders only when we can offer the goods at lower costs/prices. When our costs are more due to the assumption of the S.R. duty, our costs increase. Thus, we are forced to raise the costs/prices. So, we are to lose the foreign business, while others with no Social Responsibility concept, can easily bag the business as their costs of productions are relatively lower. So, business must not look at that.

**d) Not Right man :**

Business is not right person to think of Social Responsibility. We want right man for the right jobs. Govt. is the right agency. But, business is a bad agency to think of it. Hence, business must forget it.

**e) No-consensus-ad-idem :**

Since there is no any formal compulsions form any Government agency, and since there is no any common understanding among all business circles, it is good to be dropped.

**f) Not at a stone's throw :**

Since it is costly concept, it is good, if business does not talk about it. Especially, this S.R. concept is not within the reach of small/medium sized business. Hence, business should forget it.

**g) Govt is there :**

A right person to talk of S.R. is the Government. Hence, business has no business to talk about this business.

**h) No Formal Accountability:**

There is no any compulsion from any agency what so ever, that business should shoulder S.R. Hence, why should business take up Social Responsibility unnecessarily. Thus, the issue - S.R. has become a big subject of debate.

**16.5. Specific Social Responsibility Towards some Important Sections of Society :**

Figure (ii) given above, shows clearly the various organs and limbs of the environment external to the organisation towards which, the business organisation has got several duties and obligations. These are discussed briefly in the following sections.

**16.5.1. Towards Consumers :**

- \* Consumer is a king and there is Consumer sovereignty. This means that the corporate business sector is obliged to cater to the needs of the consumers. This is the primary obligation. This obligation is to satisfy the needs of the consumers.
- \* Business has to ensure that the goods/services marketed must live upto the expected standards with regard to quality, quantity, cost, durability etc.,
- \* It is the obligation of the business to see that needs of the consumers are met in time.
- \* It is also the obligation of the corporate sector to see that there is good match/balance between price and quality.
- \* To maximise the consumer satisfactions with regard to quality aspect, the company must make its association with quality associations viz, ISI, Agmark etc. Clear to audience.
- \* Another obligation is to see that there is assurance of uninterrupted supply of goods/services in the highly essential goods category.

- \* Continuous supply of spare parts and good after sales service facility are also important obligations to be discharged.
- \* Not to deceive with several tall promises about the utility aspects of the products is the most important obligation. This is nothing but consumers must not be deceived with false advertisements. etc.

#### **16.5.2. Towards Share holders :**

- \* Capital invested by the share holders is the hard earned money. It shall be utilised and safeguarded best. This is how the share holders are to be safeguarded.
- \* Ensuring a stable rate of dividend, though not a high rate, is a minimum obligation to be met.
- \* From time to time, the share holders must be informed of authentic and reliable information about the progress (or) otherwise of the organisation.
- \* Share holders also must never be misdirected and misled by the faulty accounting information. There must be a great deal of transparency in what they are doing, what they did and what they are going to do about.
- \* There must be good corporate Governance. etc.

#### **16.5.3 Towards Employees :**

- \* Owners and management should be kind, just and considerate towards employees
- \* Good human resource management is needed.
- \* Motivation and morale are sought to be developed.
- \* Sense of belongingness must be promoted.
- \* The treatment should be such that employees are stable with a lot of loyalty and commitment.

#### **16.5.4 Towards Trade Unions :**

- \* Normally, Company and Trade Union are considered natural enemies. This must be replaced. Management must consider the t.u. as its friend but not a foe.
- \* Company should always develop a positive attitude towards t.u.
- \* Good and Cordial relations are sought to be promoted.
- \* Collective bargaining and participative management concepts must be given weightage and implemented. etc.

#### **16.5.5. Towards Government :**

- \* To follow fair trade policies and practices.
- \* Business must be a good corporate citizen. It must be good and prompt at the payment of all taxes to the Government.
- \* Business sector must comply with all legal frame work.
- \* In all possible ways, corporate sector has to help the Government and the society in general?



- \* Not to bribe Government officials.

Thus, in all these possible ways, the business organisations will be discharging its obligations. Role of the management is to appreciate the value of systems concept that there is a lot of interdependence between company on the one hand and the society on the other hand.

### **16.6. Progress in India : (Social Responsibilities in Practice)**

Several corporate giants like : TISCO, DCM, Mafatlal Groups, Hindustal Steel, Godrej, Alembic, Bajaj L&T, Shriram Investments, Tata Steel, OTIS Elevator Company, Titan, ACC etc. are stated to have been largely busy with the S.R. concept. Examples of some contributions of some companies may be seen here.

#### **(i) Bajaj Auto :**

- \* This company is running a Samaj Seva Kendra at Akrudi near Pune, for nearly as many as 900 families as members.
- \* Main purpose of this is to improve QWL.
- \* This company also runs Janaki Devi Bajaj Gram Vikas Samstha near Pune.
- \* It's mission is to promote rural development.

#### **(ii) L & T :**

- \* It spends nearly Rs.5 Crores annually on social projects.
- \* It takes up programmes like : Family planning, Camps to checkup Tuber culosis, Dairy and Poultry development in and arround.

#### **(iii) Shriram Investments :**

- \* It started a Trust in 1992 to take up S.R. Projects.
- \* It runs a School for over 2000 children, a home for orphans, etc.
- \* It provides work sheds to women employed on the preparation of incense sticks and candles.

#### **(iv) Tata Steel :**

- \* This company is a pioneer company as far as S.R. is concerned.
- \* Deeply involved in environmental conservation activities, education, Vocational Training and health care for the under preveleged etc.

#### **(v) OTIS Elevator Company:**

- \* This company focuses on mentally retarded people.
- \* It conducts sports for the people.
- \* In 1995, the company sponsored 350 athlets from Maharashtra for the world special olympics.
- \* They are engaged on fund raising programmes for this purpose. With these funds, they provide fans,

music systems, wheel chairs, hearing aids, learning aids, etc.

- \* The company bagged an award in this regard, from USA, in 1996 and 1997, Spl. Olympics

**(vi) Titan Industries :**

- \* The Company is busily engaged in providing educational and vocational training. Programmes to the under preveleged children, by sponsoring scholarships for deserving people from Tamil Nadu.
- \* So far 281 students got benefited by going for courses like : Medicine, Engineering, Management.

**(vii) ACC (Associated Cement Company):**

- \* Medical care, rural development, Environmental conservation etc. are some of the S.R. aspects to the company.
- \* Acc has recently taken up a social project that involves conservation of heritage buildings and structures, primarily in Bombay.

**(viii) TISCO (A Detailed View)**

The fundamental mission of TISCO (Tata Iron Steel Company Limited) is to strengthen India's industrial base through increased productivity, effective utilisation of manpower and material resources, and continued application of modern scientific managerial methods as well as through the systematic growth in keeping with national aspirations. The company recognises that while honesty and integrity are the essential ingredients of a strong and stable enterprise, profitability provides the main spark for economic activity. It affirms its faith in democratic values and in the importance of success of individuals, collective and corporate enterprise for the economic emancipation and prosperity of the country. Guided by its basic philosophy, the company believes in discharging its responsibility towards :

**(a) Shareholders :**

- \* by protecting and safeguarding their investment; and
- \* by ensuring to them a fair return.

**(b) Employees :**

- \* by a realistic and general understanding and acceptance of their needs and rights and enlightened awareness of social responsibilities of industry;
- \* by providing adequate wages, good working conditions, job security, effective machinery for speedy redressal of grievances, and suitable opportunities for promotion and selfdevelopment.
- \* by promoting feelings of trust and loyalty through a human and purposeful awareness of their needs and aspiration; and
- \* by creating a sense of belongingness and team spirit through their closer association with management at various levels.

**(c) Customers :**

- \* by products of proven quality at a fair price;
- \* by fulfilling its commitments impartially and courteously in accordance with sound and straightforward business principles;
- \* by bearing their counting confidence in its productive ability and its technical competence to keep improving the quality of its products.

**(d) Community :**

- \* by respecting the dignity of the individual and acting according to the ideas of social justice;
- \* by encouraging talent and promoting civic sense among members of the community;
- \* by availing of opportunities to develop the democratic qualities involved in collective work undertaken in the interest of the community; and
- \* by assuming its proper share of social responsibilities in the community in which the company operates.

These missions of the company are directed towards making the company:

The best company to buy from,  
 A sound company to investing,  
 A good company to work for,  
 A reliable company to sell to,  
 A leading company in the corporate field of the country.

The various points are indivisible. Together as a unit , they state the fundamental management philosophy of the company. In order to fulfil its mission, TISCO has taken a number of programmes in the following directions.

\* **The city Development :** The company has developed the plant site, that is, Jamshedpur, into a full-fledged city with adequate provisions of housing, health and conservancy, medical services and related amenities.

\* **Pollution Control :** This is of very high order so that there is no pollution problem in any part of the work place or in the city.

\* **Employer-Employee Relations :** These are of very high order. Worers are given every opportunity to voice their concern through the recognised union. In fact, the union encouraged to take up the causes for improving employer-employee relationship.

\* **Consumers :** The company has adopted the policy of fair pricing and distribution of steel. Though there has been continuous shortage of steel, the company never indulged in unfair trade practices. To ensure quality, the company has very rigid quality control system.

\* **Shareholders :** An attempt is made to reward the shareholders suitably. The company could not distribute dividends when there was control over this aspect but later, the shareholders have got their due.

\* **Community Development and Social Welfare Programme :** To undertake various programmes, the company has created a separate department under the charge of Chief Social Services Manager. Various programmes under this category include: operation of community development centers, welfare of Adivasis, youth clubs, etc.

\* **Rural Development Programme :** Under this category, the company has undertaken three programmes; agricultural and crop extension, setting up of training centres of allied vocations such as dairy, poultry farming, piggery and goat breeding; establishment of village industries and imparting training in those industries.

\* **Obligations to Society :** The company has undertaken programmes like smallpox eradication, flood relief, drought and cyclone reliefs in Orissa, relief work in cyclones in Andhra Pradesh, relief work during civil disturbances in Bihar and other similar activities.

\* **Management Philosophy of ITC Ltd.**

Management philosophy of ITC limited, originally established by multinational, also suggests that the company is conscious of its responsibility to its various constituents. The management philosophy is charged with the following concerns.

- \* Concern for their ultimate customers--millions of customers.
- \* Concern for their intermediate customers--the trade.
- \* Concern for their suppliers-- their source of raw materials and ancillaries.
- \* Concern for their employees--their most valued asset.
- \* Concern for their competitors whom they wish well--for, healthy competition ultimately benefits the customer.
- \* Concern for their shareholders--the investing public.
- \* Concern for the national aspiration--India's future.

The company undertakes various programmes to fulfil its obligations to various constituents.

**16.7. Business Ethics :** The world of business ethics is quite broad and its outer edges spread into a number of areas in the larger sphere of business-society relationships. The social responsibility of business, for instance, involves ethics. All individuals, whether in business or non-business activities, are concerned with some standardised form of behaviour, commonly known as ethics. However, business ethics are filled with abstractions and precepts very difficult to apply with certainty to many business problems. There is a huge literature on the subject, but no universally accepted definition of the word ethics. A number of writers draw a distinction between morals (what people do) and ethics (what they think they ought to do). However, many

writers use the two words synonymously. Ethics may be thought of in terms of a mass of moral principles or sets of values about what conduct ought to be. Therefore, ethics specify what is good or bad, right or wrong. Words frequently encountered in discussions of ethics are true, fair, just, right, proper and so on.

Business ethics relate to the behaviour of a businessman in a business situation. They are concerned primarily with the impacts of decisions on people, within and without the organisation, individually and collectively in communities or other groups. They are concerned with actions measured by a ethical rules, as contrasted with strictly economic or financial rules. Business ethical behaviour is conduct that is fair and just over and above the various rules and regulations. It is always ethical for a businessman to obey the laws eventhough he may personally believe them to be unjust or immoral. If he feels that laws are unjust, he can seek remedy through proper procedure and not through disobedience of those.

**16.7.1. Determinants of Ethics :** The key forces that shape the ethics of a person may be stated thus :

\* **Family, school and religion :** The formation of ethics begins early in life. As child, one learns about what is good and bad from parents. Through their reinforcing actions (rewarding good behaviours), parents inculcate high or low ethical standards among children. Schools and religion also greatly influence the formation of ethical values (such as truthfulness, honesty, sincerity, tolerance, etc.) at an early age.

\* **Peers, colleagues and superiors :** In the company of good friends, the child realises the importance of high ethical standards in life. If he were to make friendship with peers who steal, smoke and use drugs, he will probably accept those behaviours as ethical. Colleagues in an organisation too, shape the value system of an individual. He adopts the attitudes, beliefs and values of the group to which he belongs. Likewise, most people yield to pressure from superiors in doing things that may consider unethical otherwise.

\* **Experiences in life :** Experiences in life teach many lessons. These could be bitter or sweet, depending on the ability of person to reach goals. If a person is not given 'pat on the back' for good behaviour while others earn rewards for bad behaviour, the person will probably alter both ethical standards and behavioural responses in future.

\* **Values and morals :** People who value material possessions in life may not have strong ethical standards regarding behaviours that lead to accumulation of personal wealth. On the other hand people who place a premium on quality of life will probably have strong ethics while competing with others for various things in life.

\* **Threatening situations :** An employee threatened with losing a permanent job may resort to unethical acts to save his job. To meet pre-determined targets, many bank managers sanction loans to individuals with practically no credit-worthiness. A house wife may practically beat a thief to death, when treated with the prospect of losing her ornaments or child. Situations like these, force people to change their ethics and respond in an unexpected manner.



\* **Organisational demands** : There is growing research evidence to show that managers at top, middle and first level have compromised their personal principles to meet an organisational demand. Corporate goals are paramount and exert considerable pressure on executives to change their ethical views.

\* **Legislation** : Laws are generally passed in response to social demands. Factors such as low ethical standards, corruption in public life, absence of social responsibility, exploitation, sexual harassment etc, often force people to demand legislative protection. A practice can be made illegal, if society views it as being unethical. For example, if contribution to political parties by companies is being viewed as excessive and unethical, the practice can be banned.

\* **Government rules and regulations** : Government regulation regarding product safety, working conditions, statutory warnings (on cigarettes and other harmful products) etc., are all supported by laws. These offer guidelines to managers in determining what are the acceptable standards and practices.

\* **Industry and company ethical codes of behaviour** : Many times specific guidelines are provided to managers by the company's ethical codes of behaviour. One important question in such cases, is whether individuals within the organisations are really governed by the code of ethics or provide only lip service to the guidelines.

\* **Social Pressures** : Social forces and pressures have considerable influence on ethics in business. Society, in the recent past has demonstrated how a special status can be conferred on backward castes, boycotted products, and severe action to prevent the construction of nuclear power plants. Such actions by different groups in society may, in fact, force management to alter certain decisions by taking a broader view of the environment and the needs of the society.

**16.7.2. Merits of Ethics** : The ethical codes serve a number of purposes by specifying behaviour that is required for the protection and continuity of the professional group as a whole. Prescription of behaviour serves as a clue to what type of response is expected in a given situation. Thus, various groups associated with the functioning of professional group are served in the following manner.

\* **Customers** : Customers dealing with the organisations following some codes may benefit as they are sure that no undesirable transactions will be conducted. This also gives them a fair amount of confidence in dealing with the organisation concerned. Thus they are relieved of unnecessary anxiety.

\* **Employees** : Employees or organisation benefits by the codes because these provide guidelines for their behaviour. They can know easily what is expected of them. They can distinguish very easily what is ethical or unethical and can avoid unethical behaviour. In fact, many times, employees engage themselves in unethical behaviour because they are not able to distinguish between ethical and unethical behaviour.

\* **Organisation :** The organisation can derive benefits from ethical codes as it requires less control of employees behaviour because these may serve as regulatory measure for its members. Moreover, the codes may serve as basis for maintaining external relations also.

\* **Industry :** The industry may derive benefits from ethical codes as these provide for fair trade practices resulting into healthy competition among its various constituents. This results into the growth of the industry in most socially acceptable way.

\* **Society :** The ultimate benefit of ethical codes goes to society. In fact, ethical environment of managers is a part of their social environment. The social cause is served better if all professionals forming its part follow certain specified behaviour.

### 16.7.3. The Johnson & Johnson-Code of Ethics : (An Example)

- \* We believe our first responsibility is to the doctors, nurses, and patients, mothers and all others who use our products and services.
- \* In meeting their needs, everything we do must be of high quality.
- \* We must constantly strive to reduce our costs in order to maintain reasonable prices.
- \* Customers orders must be serviced promptly and accurately.
- \* Our suppliers and distributors must have an opportunity to make a fair profits.
- \* We are responsible to our employees, the men and women who work with us throughout the world.
- \* Everyone must be considered as an individual.
- \* We must respect their dignity and recognise their merit.
- \* They must have a sense of security in their jobs.
- \* Compensation must be fair and adequate, and working conditions clean, orderly and safe.
- \* Employees must feel free to make suggestions and complaints.
- \* There must be equal opportunity for employment, development, and advancement for those qualified.
- \* We must provide competent management, and their actions must be just and ethical.
- \* We are responsible to be communities in which we live and work and to the world community as well.
- \* We must be good citizens, support good works and charities and bear our fair share of taxes.
- \* We must encourage civic improvements and better health and education.
- \* We must maintain in good order, the property, we are privileged to use, protecting the environment and natural resources.
- \* Our final responsibility is to our stockholders.

- \* Business must make a sound profit.
- \* We must experiment with new ideas.
- \* Research must be carried on innovative programs developed and mistakes paid for.
- \* New equipment must be purchased, new facilities provided, and new products launched.
- \* Reserved must be created to provide for adverse times.
- \* When we operate according to these principles, the stockholders should realise a fair return.

**16.8. Summary :** Business and Society are closely related with each other. They are very much dependent upon each other. Systems concept tells that business cannot remain in isolation and it has to care for the society in several ways and **Vice-Versa**. Business Managers have to think much about society while they take any critical decisions which may leave any adverse impact on society.

**16.9. Key words :**

1. **Social Responsibility :** It is a serious consideration by the the corporate sector the impact of its actions on the society.
2. **Charity Principle :** It is the ability of the company to relate its operations and policies to the social environment in ways that are mutually beneficial to the company and the society as well.

**16.10. Self Assessment Questions :**

1. Why is discussion on Social Responsibility of Business, becoming a good debatable issue?
2. What are specific social obligations that business has to care for towards consumers and trade unions?
3. How are Social Responsibilities and Business Ethics related to each other?

**16.11. Further Reading :**

- \* Harold Koontz, Management
- \* LM Prasad, Management
- \* VSP Rao and Hari Krishna, Management
- \* James Stoner, Management

**Dr. G. Satyannarayana**